



# TnT speeltoestellen

## Montagehandleiding K-440



---

Toestel typenummer	<b>K-440</b>
Datum montagehandleiding	<b>07/02/2020</b>
Versienummer montagehandleiding	<b>2.0</b>

---

Beste klant van TnT Speeltoestellen,

Wij danken u voor het aanschaffen en installeren van een speeltoestel van TnT Speeltoestellen. Wij waarderen het vertrouwen dat u in ons bedrijf heeft geplaatst en streven ernaar om uw vertrouwen meer dan waar te maken!

Dit is uw TnT speeltoestellen montagehandleiding.

Wij hebben deze handleiding specifiek voor het product ontworpen, waarop eveneens de toe te passen onderdelen zijn genoemd.

Ook vindt u het grondplan met de benodigde valruimte volgens norm NEN-EN1176-1 : 2017.

Bewaart u dit document bij uw logboek. Nogmaals willen wij u bedanken voor de aankoop van dit speeltoestel. Wij zien uit naar uw volgende speelproject.

Met vriendelijke groet, TnT Speeltoestellen



## Inhoudsopgave

Aanzichten 3D .....	3
Onderdelenlijst .....	4
Veiligheidsruimtes .....	5
Aanzichten 2D .....	6
Plattegrond palenplan .....	7
Onderdeel handleidingen .....	8
<i>Staander K-440</i> .....	9
<i>Stang K-440</i> .....	11
<i>K-440 Klimrek</i> .....	13
<i>Verticaal klimnet K-440</i> .....	15
<i>Driehoeks net K-440</i> .....	17

## Aanzichten 3D





Aanzicht 1



Aanzicht 3

## Onderdelenlijst

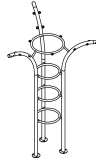
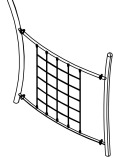
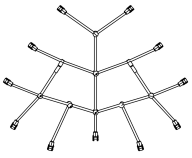
<p><b>3 st. Staander K-440</b></p>	<p><b>6 st. Stang K-440</b></p>	<p><b>1 st. K-440 Klimrek</b></p>	<p><b>3 st. Verticaal klimnet K-440</b></p>
<p>358xØ11.4 cm</p>	<p>293 cm</p>	<p>60x46x276 cm</p>	<p>185x150cm</p>
			
<p><b>3 st. Driehoeks net K-440</b></p>			
<p>140x90 cm</p>			
			



## Veiligheidsruimtes

Geachte klant,

Zorg er altijd voor dat alle veiligheids ruimtes zoals aangegeven in ieder geval gehaald worden, dit zijn de minimale vereiste ruimtes voor een veilig gebruik van het speeltoestel.

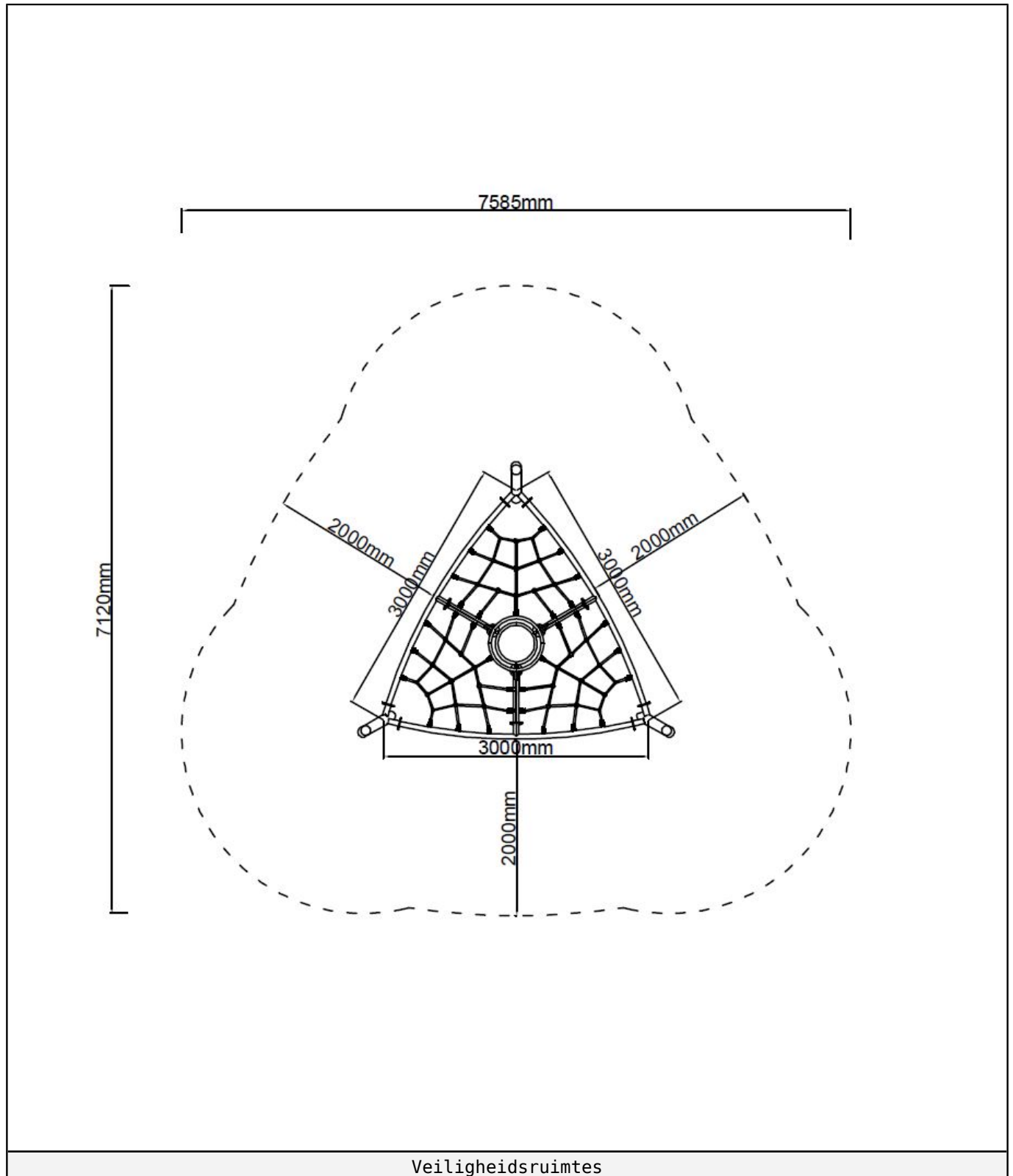

## Aanzichten 2D

Hier vindt u de beschikbare aanzichtstekeningen.

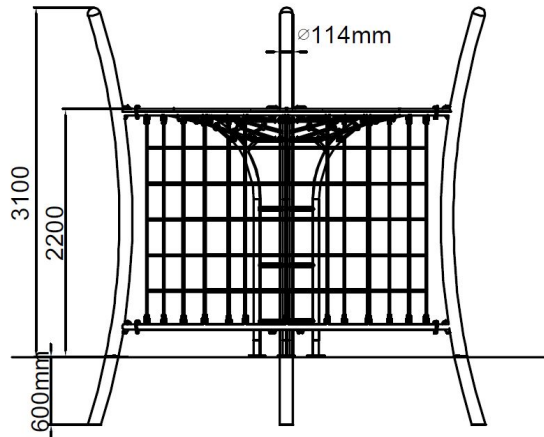

Vooraanzicht

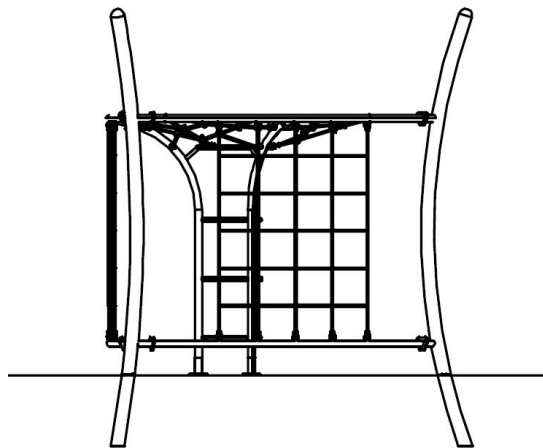

Zijaanzicht



## Plattegrond palenplan

U kunt van deze tekening niet afmeten!

Voor de betonfundatie heeft u 75 kg snelbeton per staander nodig, voor de overige onderdelen 75 kg snelbeton.

Houdt u er rekening mee dat de betonfundatie minimaal 400mm onder het maaiveld blijft, zoals op de tekening afgebeeld.

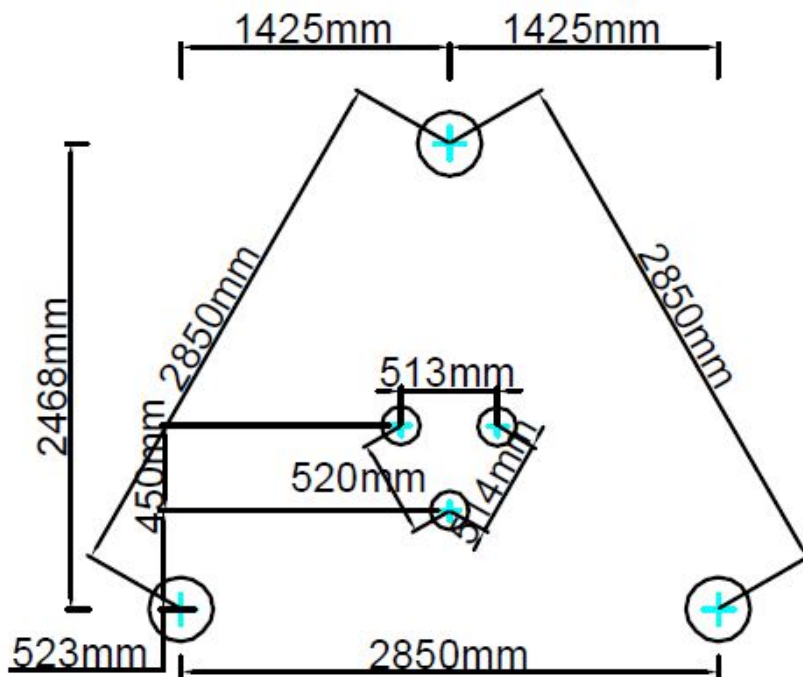

Plattegrond palenplan

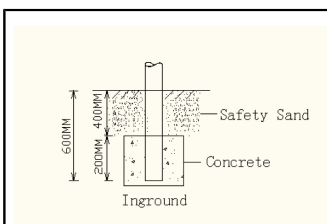

Betonfundatie



## Onderdeel handleidingen

Op de volgende pagina's van dit document vindt u alle individuele onderdelen met bijhorende technische tekeningen en eventuele montage instructies.





### Staander K-440

3 STUKS

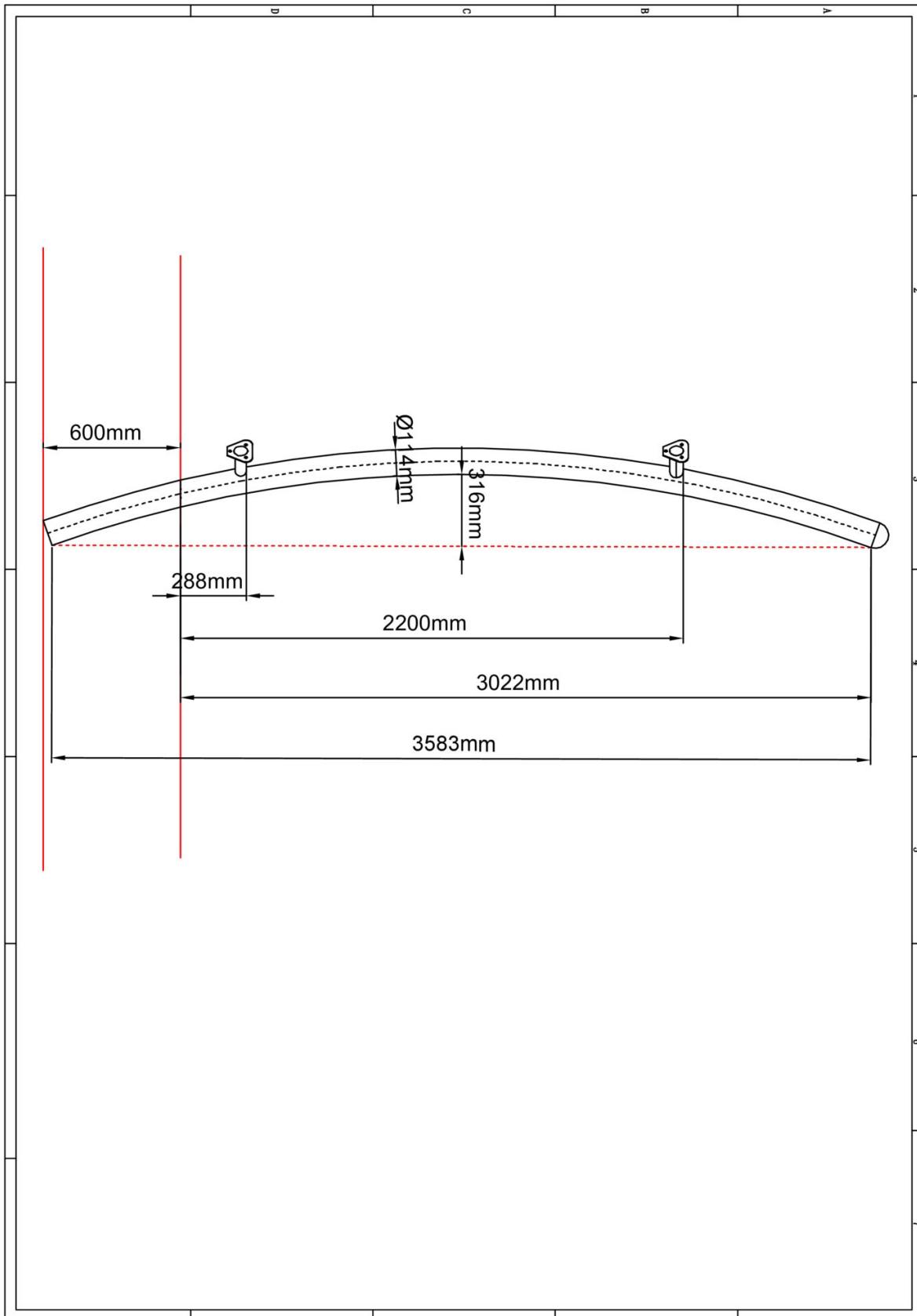

Hoofdafmetingen: 358xØ11.4 cm



## Staander K-440

STAP 1 van 1

**Omschrijving:** Kunststof paalkap kan worden vastgezet met een zelftapschroef

1 st. Kunststof paalkap	2 st. Zeskant M3X16 Zelftap
	

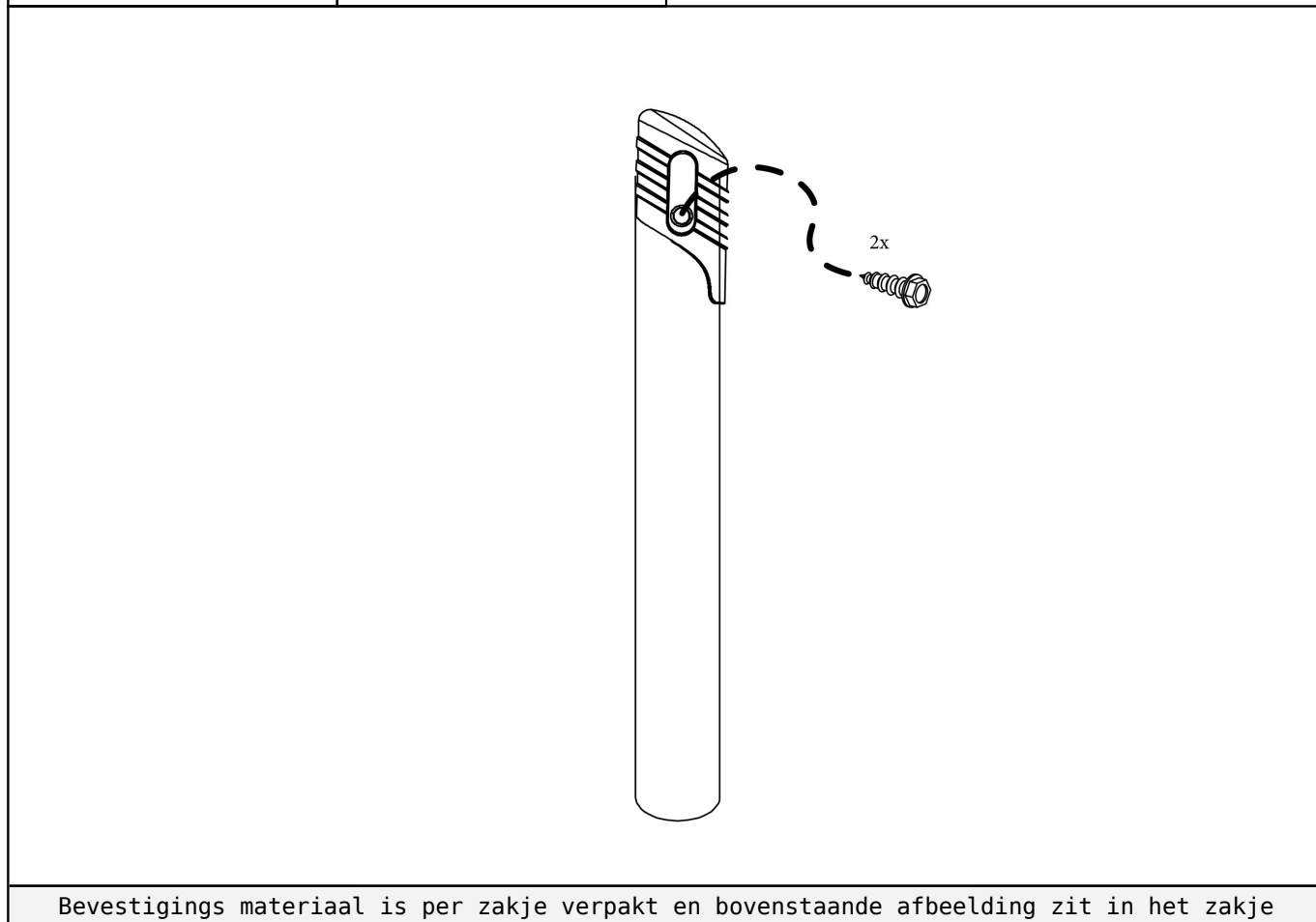

Bevestigings materiaal is per zakje verpakt en bovenstaande afbeelding zit in het zakje

### Stang K-440

6 STUKS

Hoofdafmetingen: 293 cm

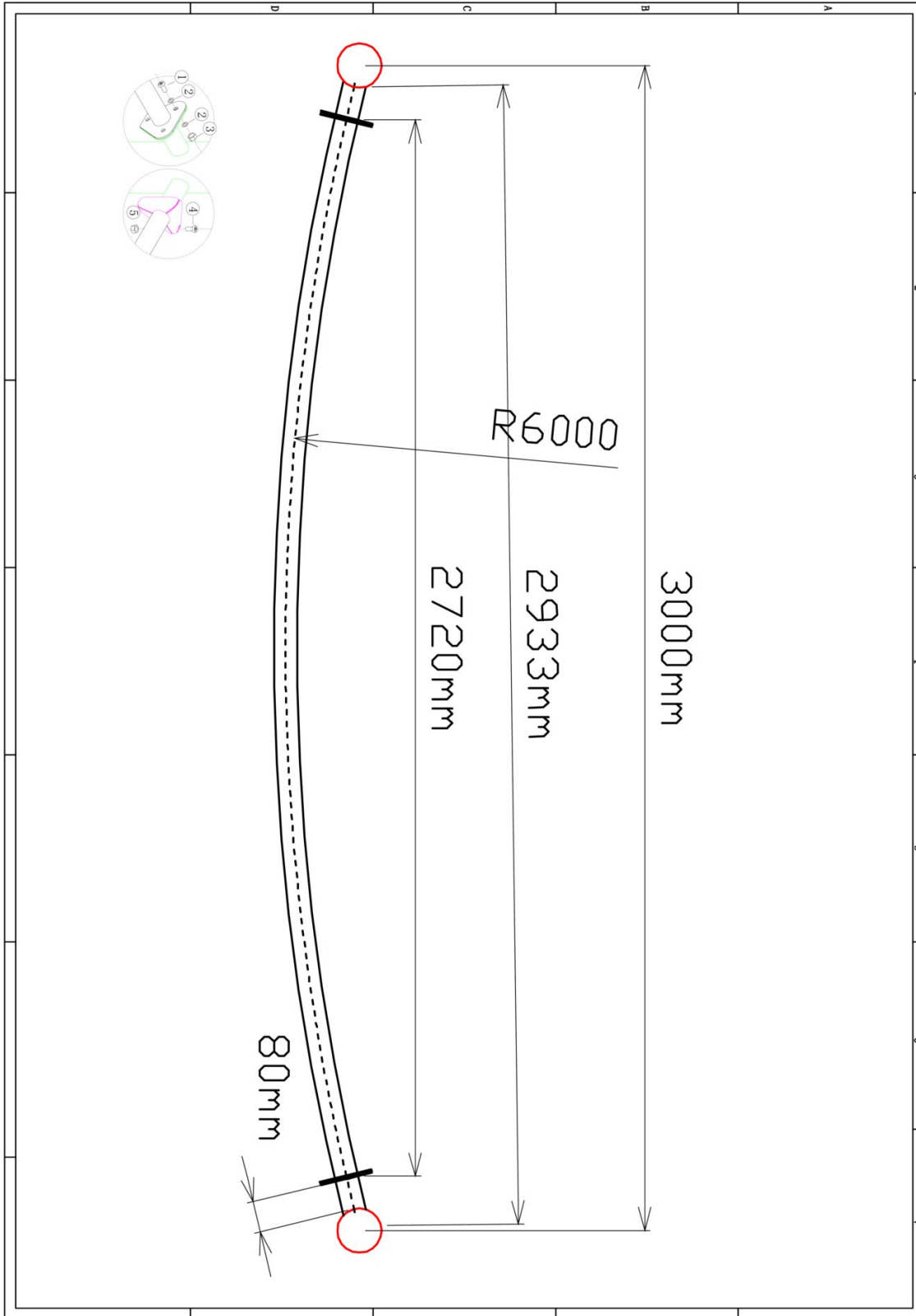

## Stang K-440

STAP 1 van 1

**Omschrijving:** Bevestiging tussen staander en de stang

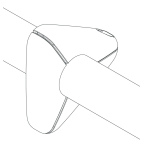
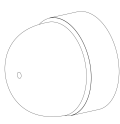
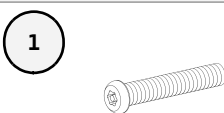
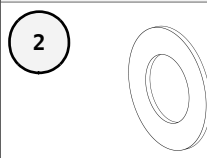
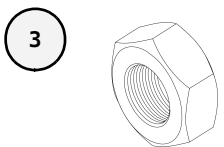
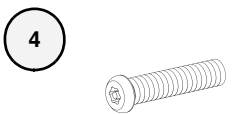
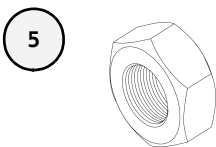
2 st. Kunststof afdekkap	2 st. Afdekdop M8	6 st. Torx M10X25	12 st. Ring M10 (middel)
			
6 st. Lock Moer M10	2 st. Torx M8X20	2 st. Lock Moer M8	
			

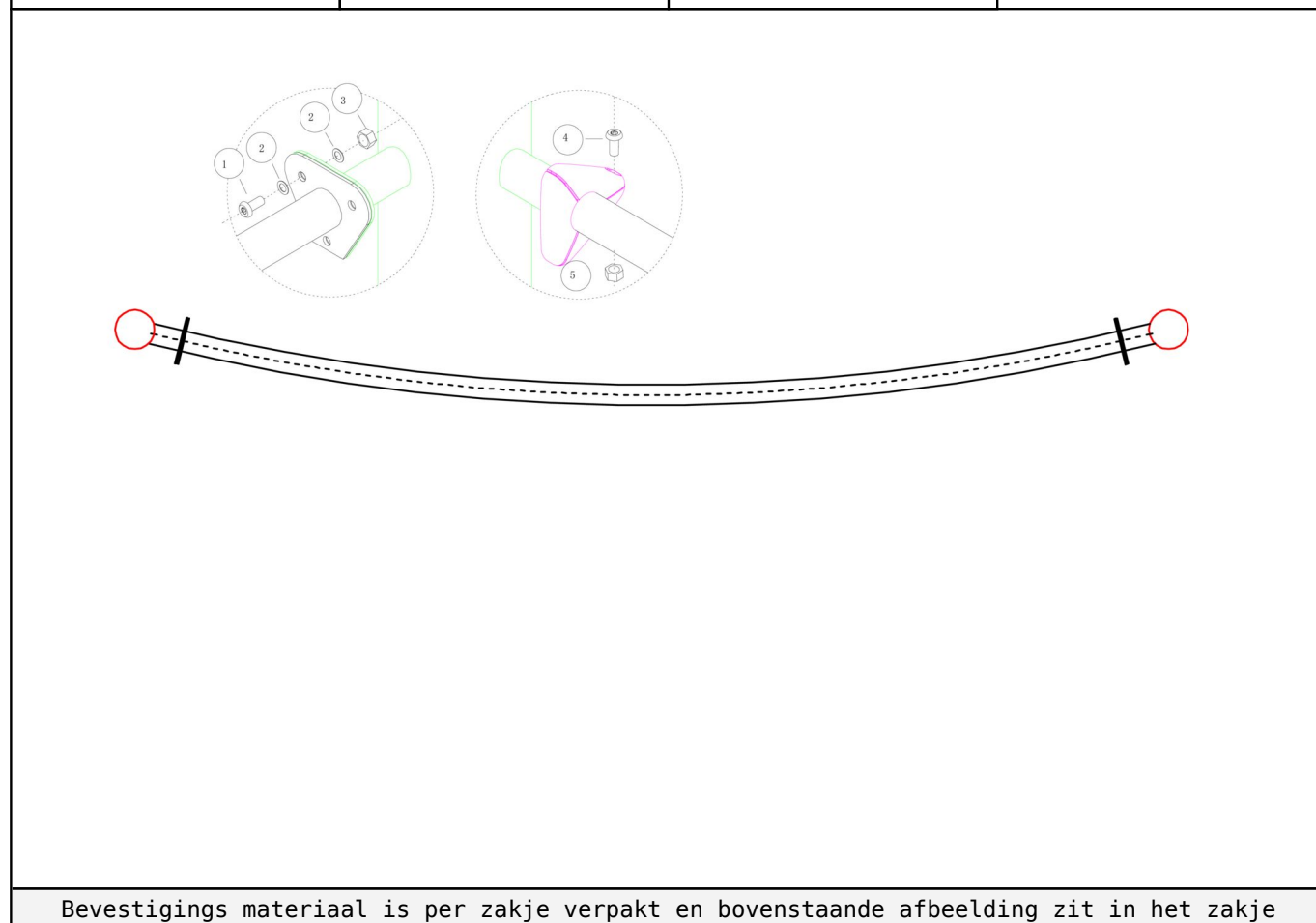



### K-440 Klimrek

1 STUK

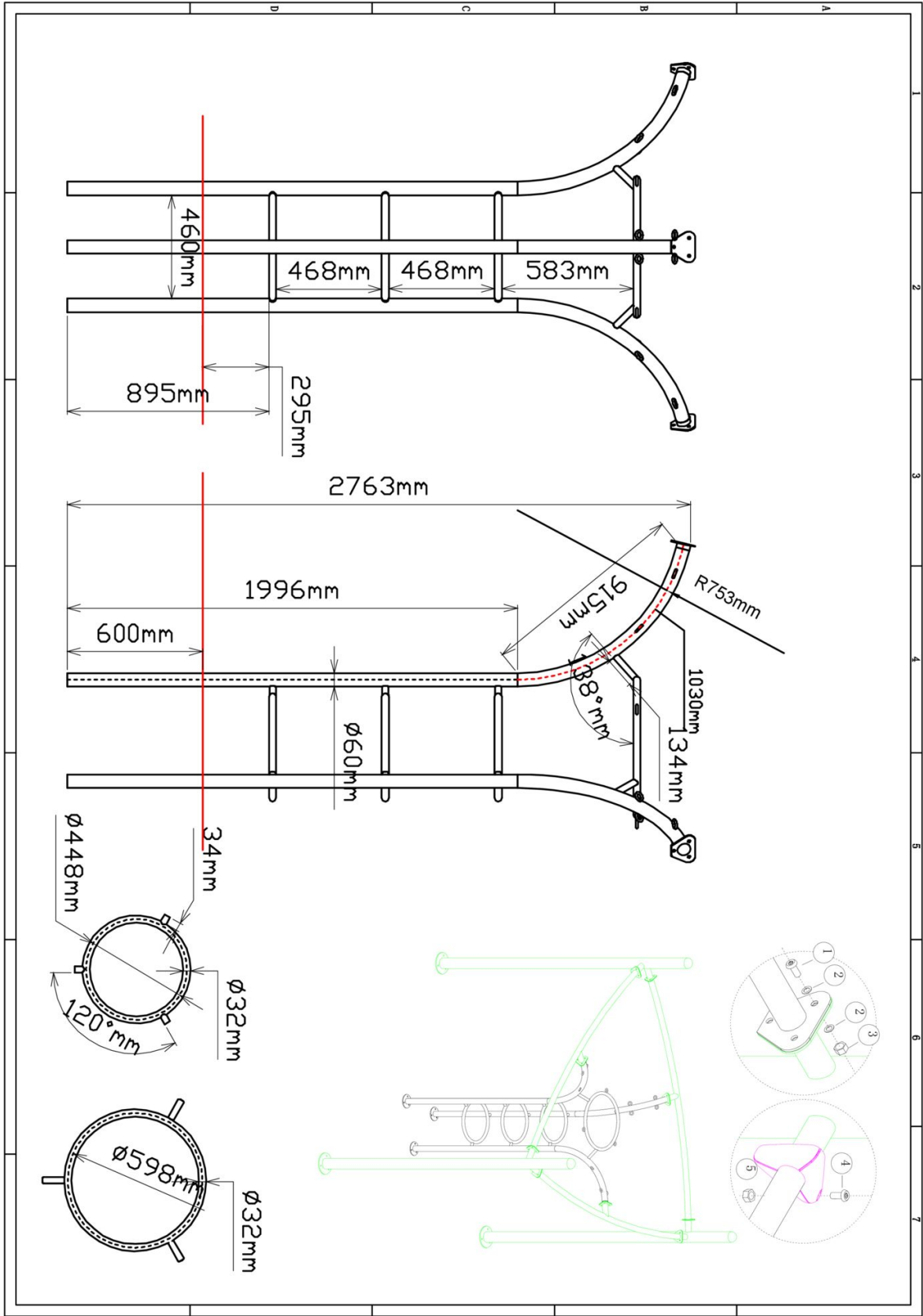

Hoofdafmetingen: 60x46x276 cm



**K-440 Klimrek**

STAP 1 van 1

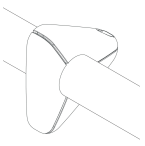
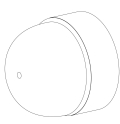
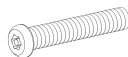
**Omschrijving:** Bevestiging tussen het klimrek en de stangen.

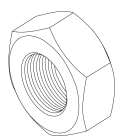
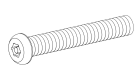
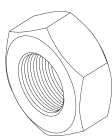
3 st. Kunststof afdekkap	3 st. Afdekdop M8	9 st. Torx M10X25	18 st. Ring M10 (middel)
		① 	② 
9 st. Lock Moer M10	3 st. Torx M8X30	3 st. Lock Moer M8	
③ 	④ 	⑤ 	

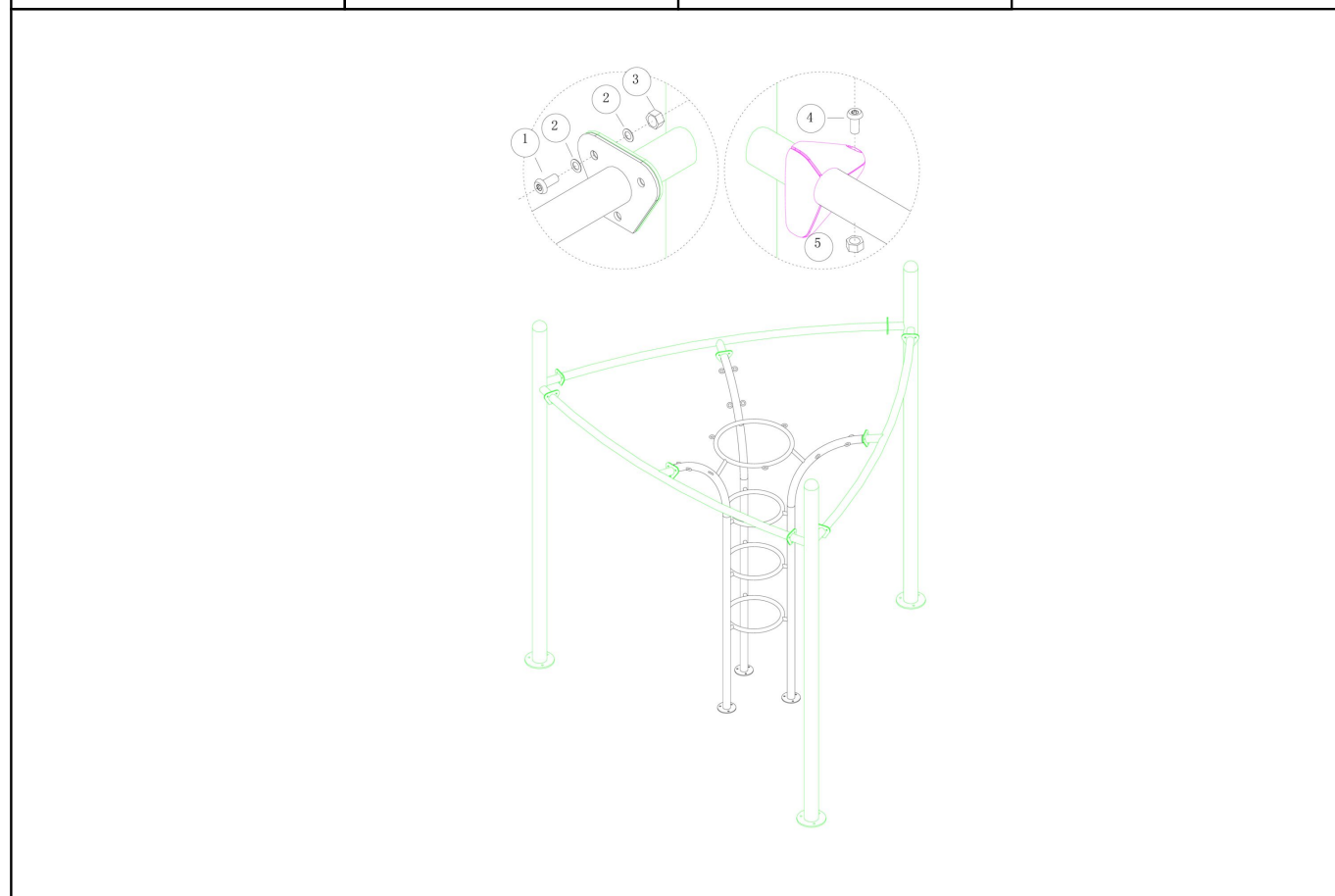

Bevestigings materiaal is per zakje verpakt en bovenstaande afbeelding zit in het zakje

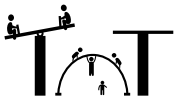

### Verticaal klimnet K-440

3 STUKS

Hoofdafmetingen: 185x150cm

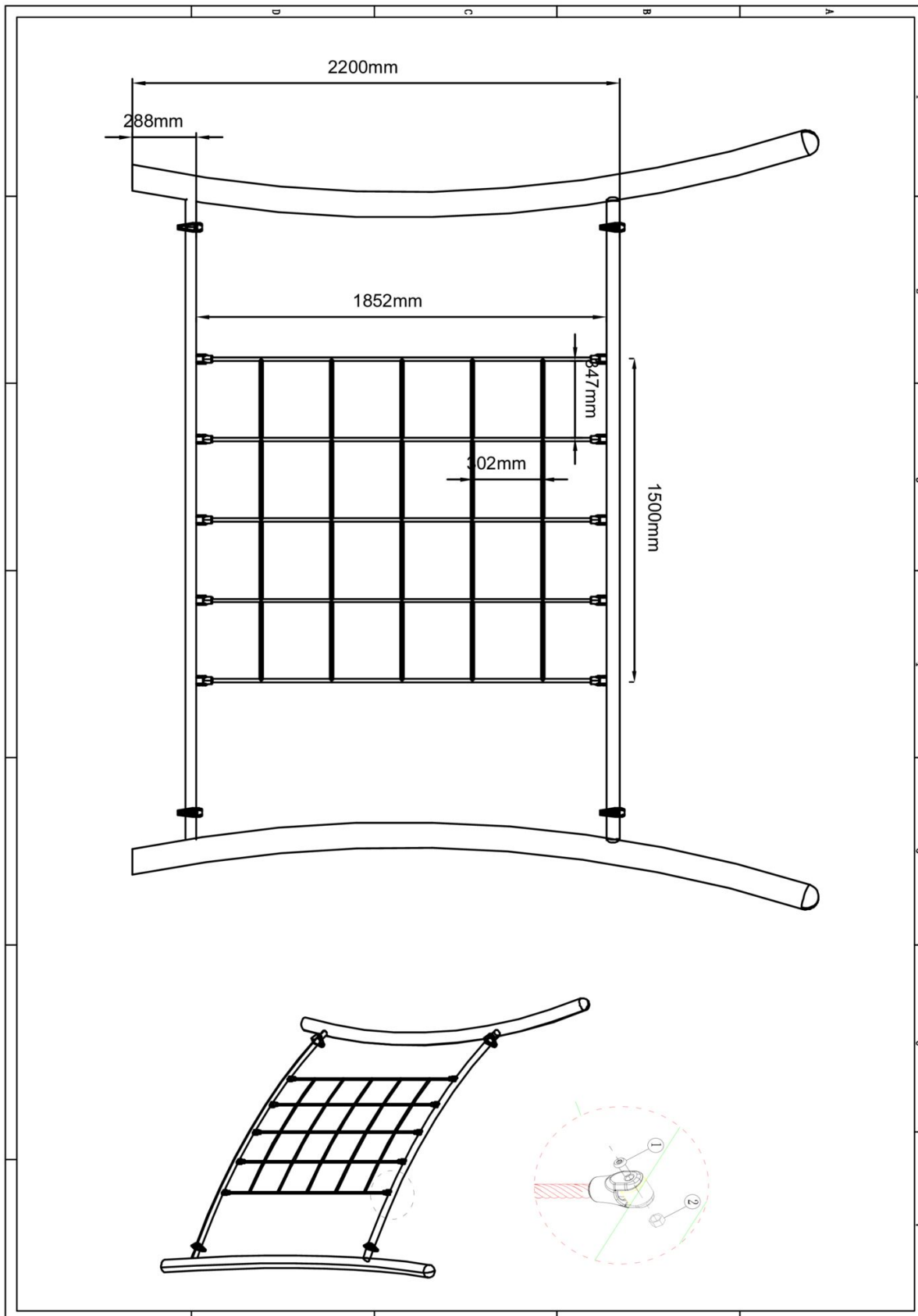

## Verticaal klimnet K-440

STAP 1 van 1

**Omschrijving:** Bevestiging tussen de stangen en het verticale klimnet

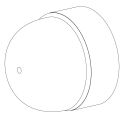
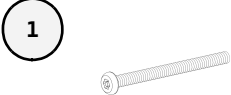
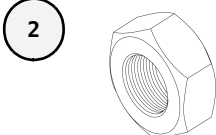
10 st. Afdekdop M10	10 st. Torx M10X55	10 st. Lock Moer M10
	 <span style="border: 1px solid black; border-radius: 50%; padding: 2px 5px;">1</span>	 <span style="border: 1px solid black; border-radius: 50%; padding: 2px 5px;">2</span>

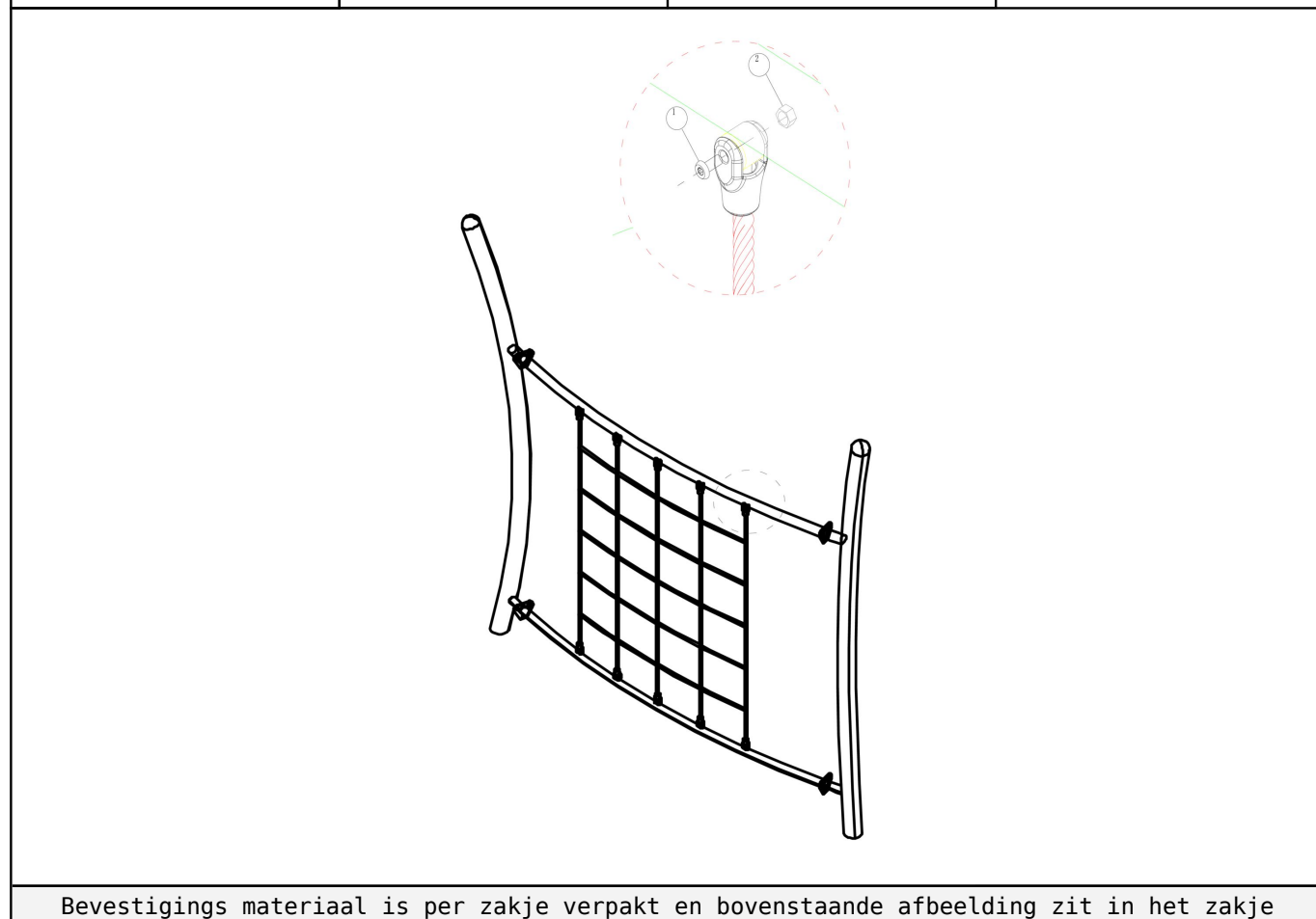



### Driehoeks net K-440

3 STUKS

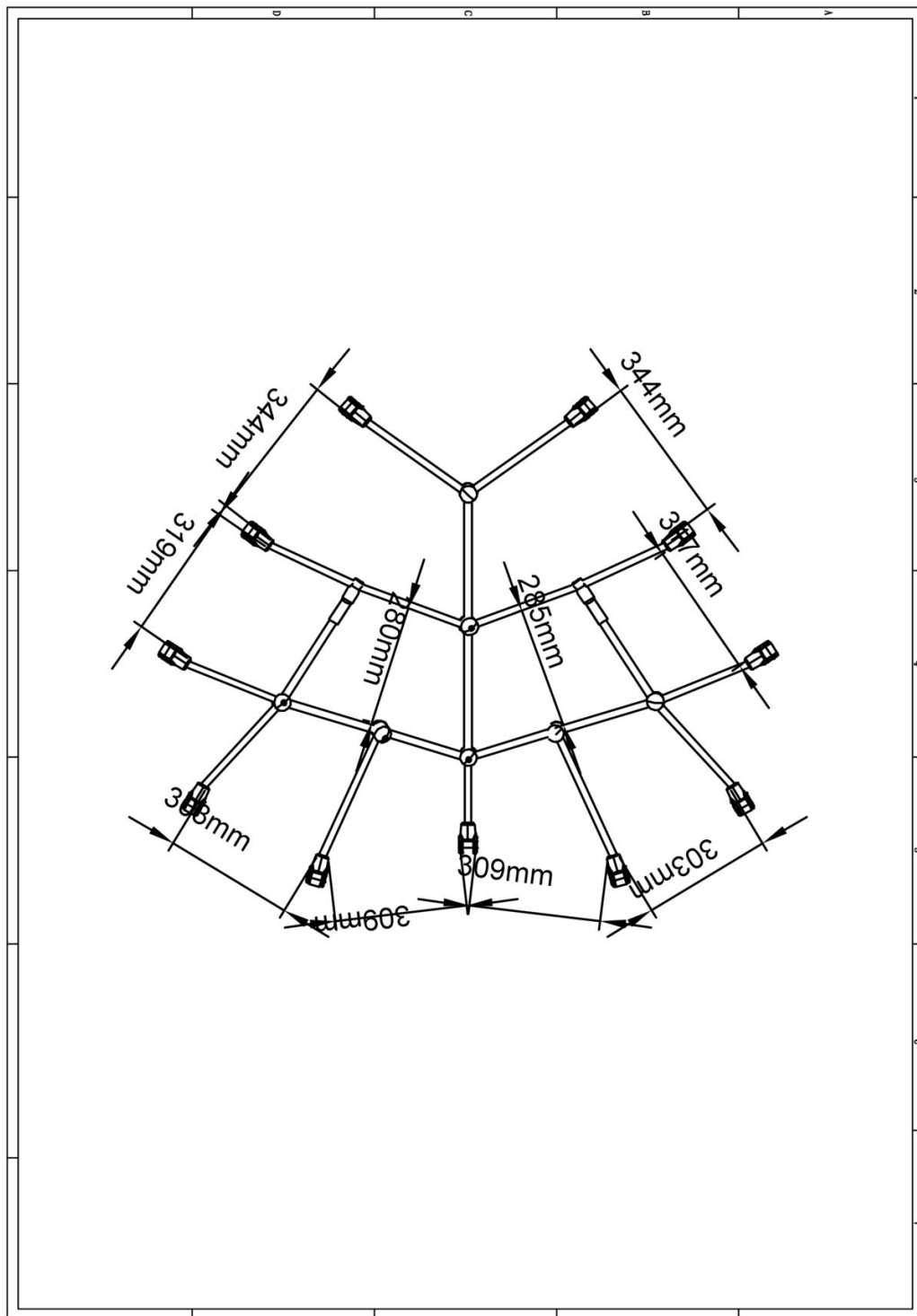

Hoofdafmetingen: 140x90 cm



## Driehoeks net K-440

STAP 1 van 1

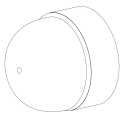
**Omschrijving:** Bevestiging tussen het net en de stangen

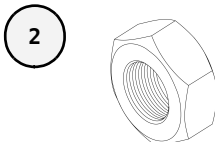
11 st. Afdekdop M10	11 st. Torx M10X55	11 st. Lock Moer M10
		

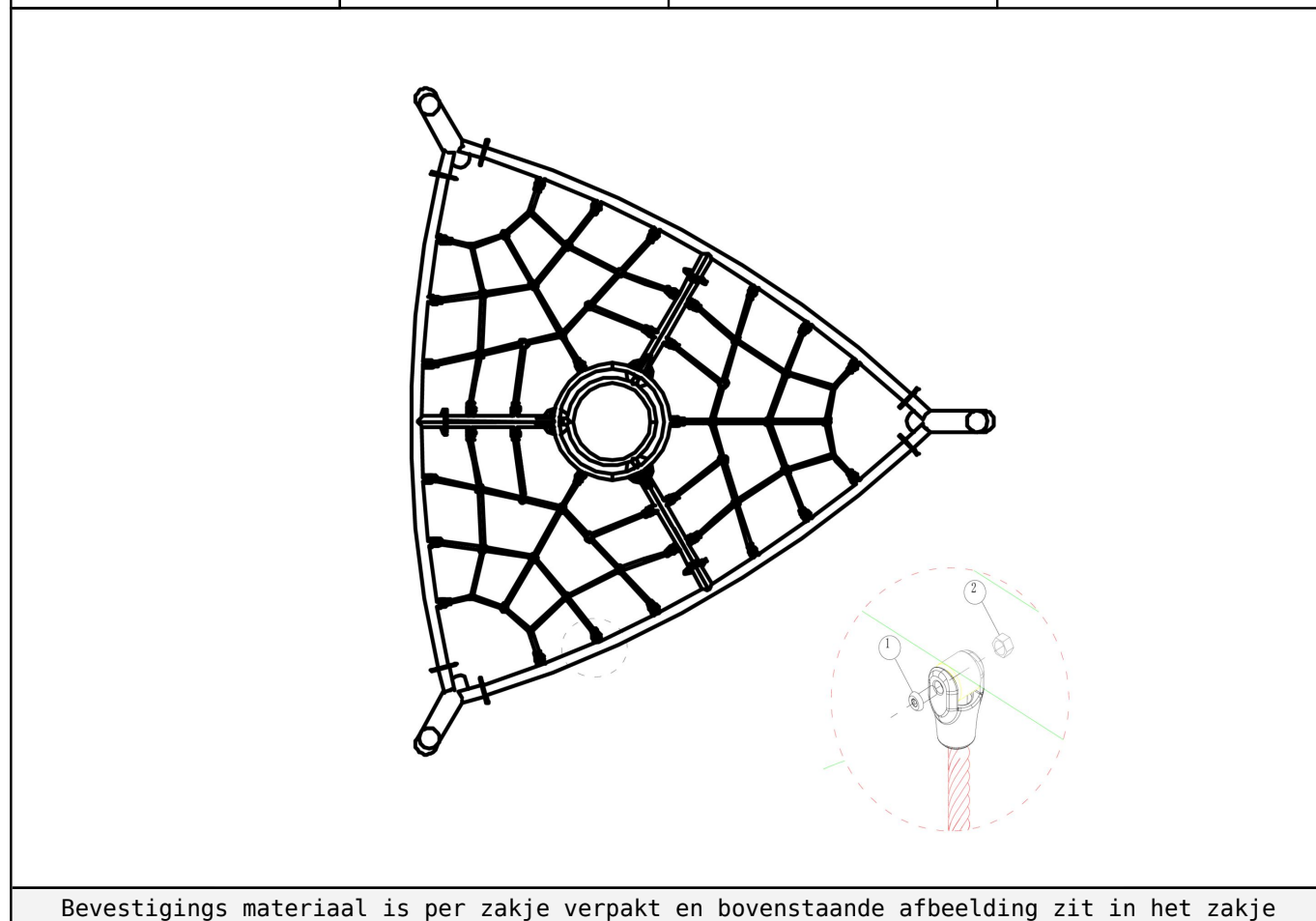

Bevestigings materiaal is per zakje verpakt en bovenstaande afbeelding zit in het zakje