



TnT speeltoestellen

Montagehandleiding PE-210604



Toestel typenummer	PE-210604
Datum montagehandleiding	27/01/2025
Versienummer montagehandleiding	2.0

Beste klant van TnT Speeltoestellen,

Wij danken u voor het aanschaffen en installeren van een speeltoestel van TnT Speeltoestellen. Wij waarderen het vertrouwen dat u in ons bedrijf heeft geplaatst en streven ernaar om uw vertrouwen meer dan waar te maken!

Dit is uw TnT speeltoestellen montagehandleiding.

Wij hebben deze handleiding specifiek voor het product ontworpen, waarop eveneens de toe te passen onderdelen zijn genoemd.

Ook vindt u het grondplan met de benodigde valruimte volgens norm NEN-EN1176-1 : 2017.

Bewaart u dit document bij uw logboek. Nogmaals willen wij u bedanken voor de aankoop van dit speeltoestel. Wij zien uit naar uw volgende speelproject.

Met vriendelijke groet, TnT Speeltoestellen



Inhoudsopgave

Aanzichten 3D	3
Onderdelenlijst	4
Veiligheidsruimtes	5
Aanzichten 2D	6
Plattegrond palenplan	7
Onderdeel handleidingen	8
.....	9
.....	10
<i>Framedeel 2 Locomotief</i>	11
<i>Framedeel 3 Locomotief</i>	12
<i>Framedeel 1 Locomotief</i>	13
<i>Dak Locomotief</i>	15
<i>paneel 1 (Locomotief)</i>	17
<i>Bank paneel 2 (Locomotief)</i>	19
<i>Locomotief wiel (groot)</i>	20
<i>Bank paneel 1 (Locomotief)</i>	22
<i>Paneel 2 (Locomotief)</i>	24
<i>Wiel Locomotief (klein)</i>	26
<i>Paneel 3 (Locomotief)</i>	28
<i>Paneel 4 (Locomotief)</i>	30
<i>Paneel 5 (Locomotief)</i>	32
<i>Locomotief stang</i>	34
<i>Schoorsteen Locomotief</i>	36

Aanzichten 3D

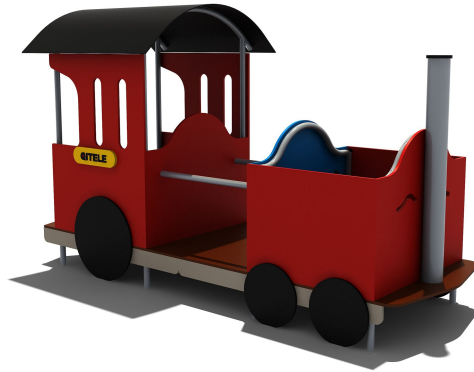

Aanzicht 1



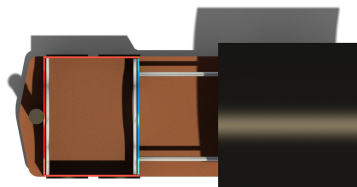

Aanzicht 2

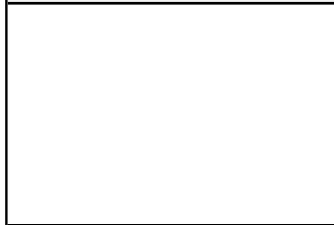
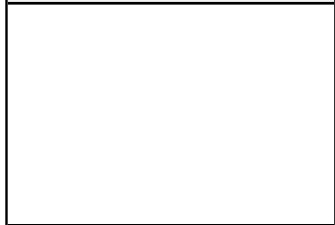

Aanzicht 3

Onderdelenlijst

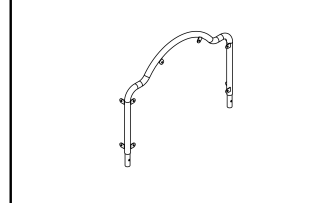
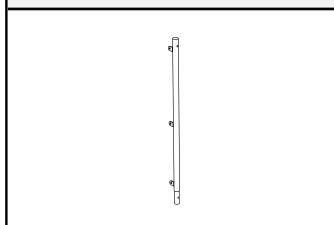
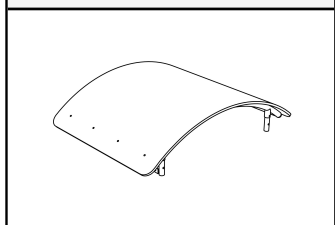
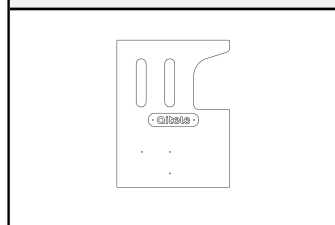
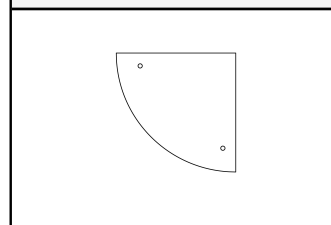
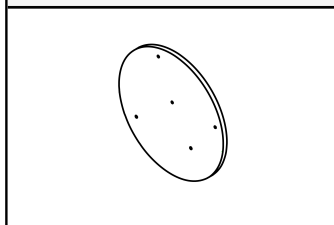
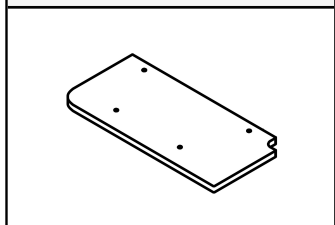
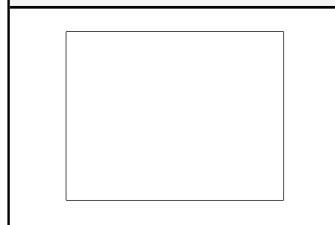
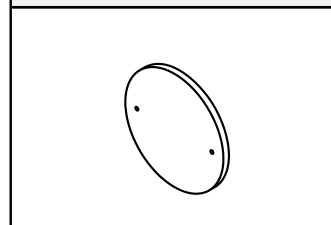
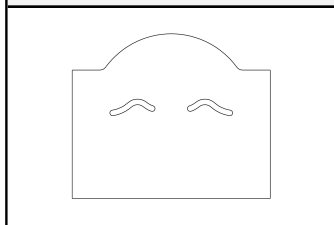
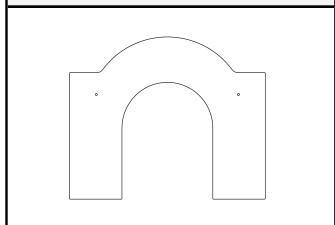
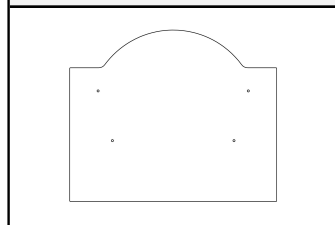
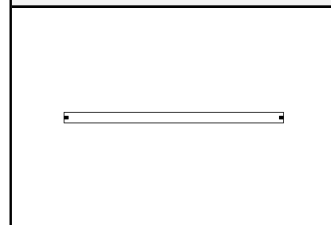
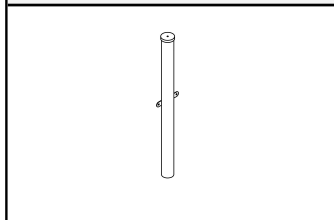
1 st. 	8 st. 	2 st. Framedeel 2 Locomotief 123x10x4 cm 	2 st. Framedeel 3 Locomotief 97x78x7 cm 
2 st. Framedeel 1 Locomotief 123x7x4 cm 	1 st. Dak Locomotief 129x100x33 cm 	2 st. paneel 1 (Locomotief) 118x91x2 cm 	4 st. Bank paneel 2 (Locomotief) 25x25x2 cm 
2 st. Locomotief wiel (groot) Ø55x2 cm 	2 st. Bank paneel 1 (Locomotief) 55x26x2 cm 	2 st. Paneel 2 (Locomotief) 81x62x2 cm 	4 st. Wiel Locomotief (klein) Ø 34x2 cm 
1 st. Paneel 3 (Locomotief) 97x80x2 cm 	1 st. Paneel 4 (Locomotief) 97x80x2 cm 	1 st. Paneel 5 (Locomotief) 97x80x2 cm 	2 st. Locomotief stang 79x4 cm 
1 st. Schoorsteen Locomotief 120x15 cm 			

Veiligheidsruimtes

Geachte klant,

Zorg er altijd voor dat alle veiligheids ruimtes zoals aangegeven in ieder geval gehaald worden, dit zijn de minimale vereiste ruimtes voor een veilig gebruik van het speeltoestel.

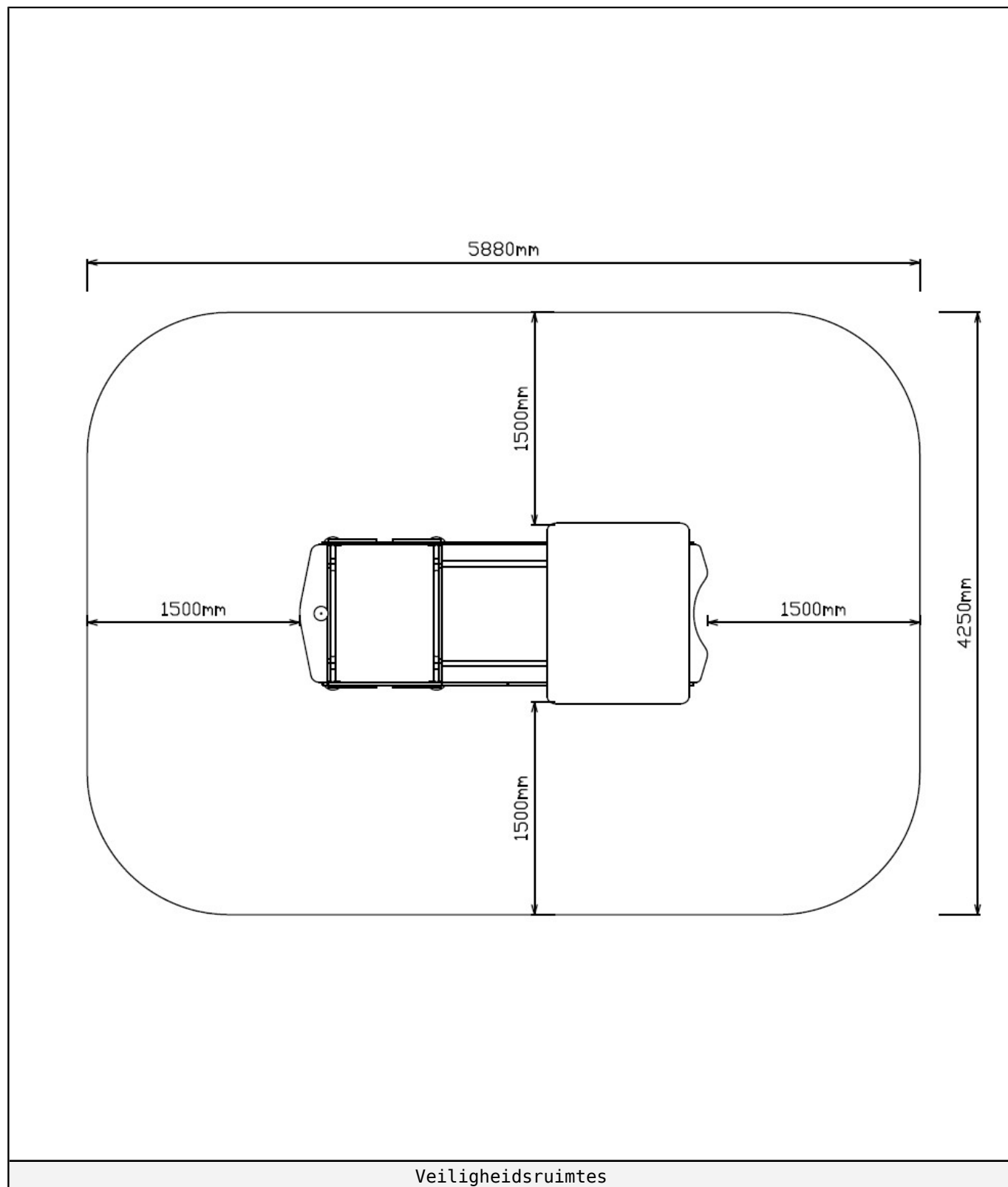

Aanzichten 2D

Hier vindt u de beschikbare aanzichtstekeningen.

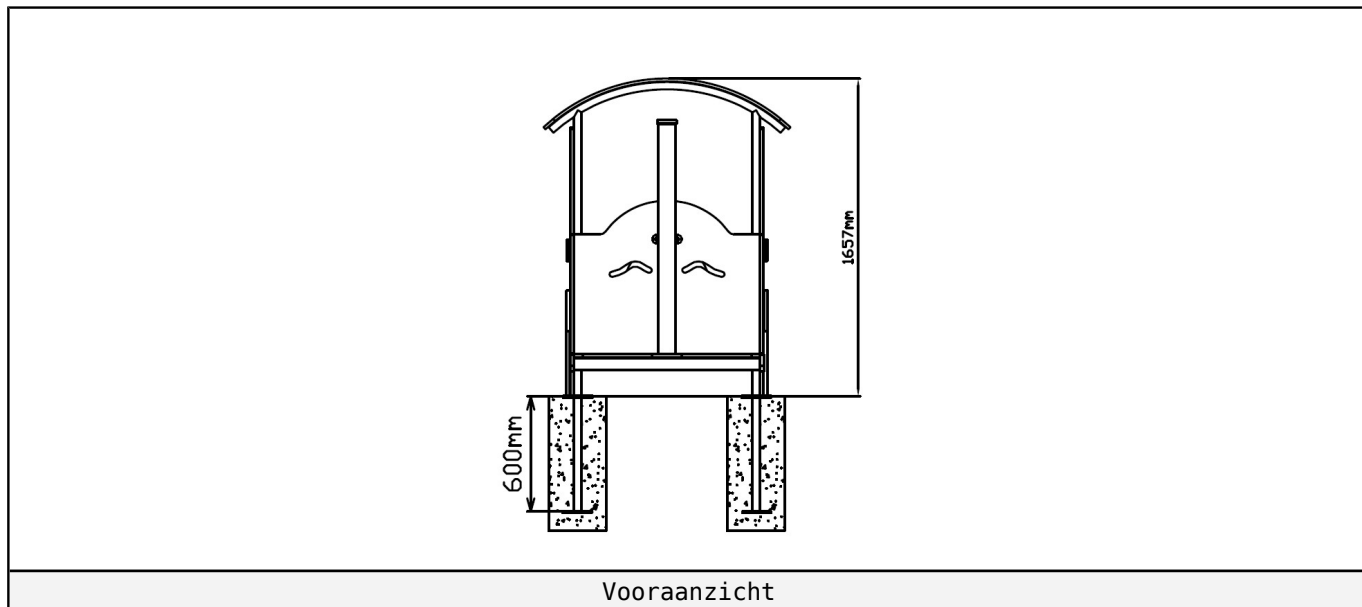

Vooraanzicht

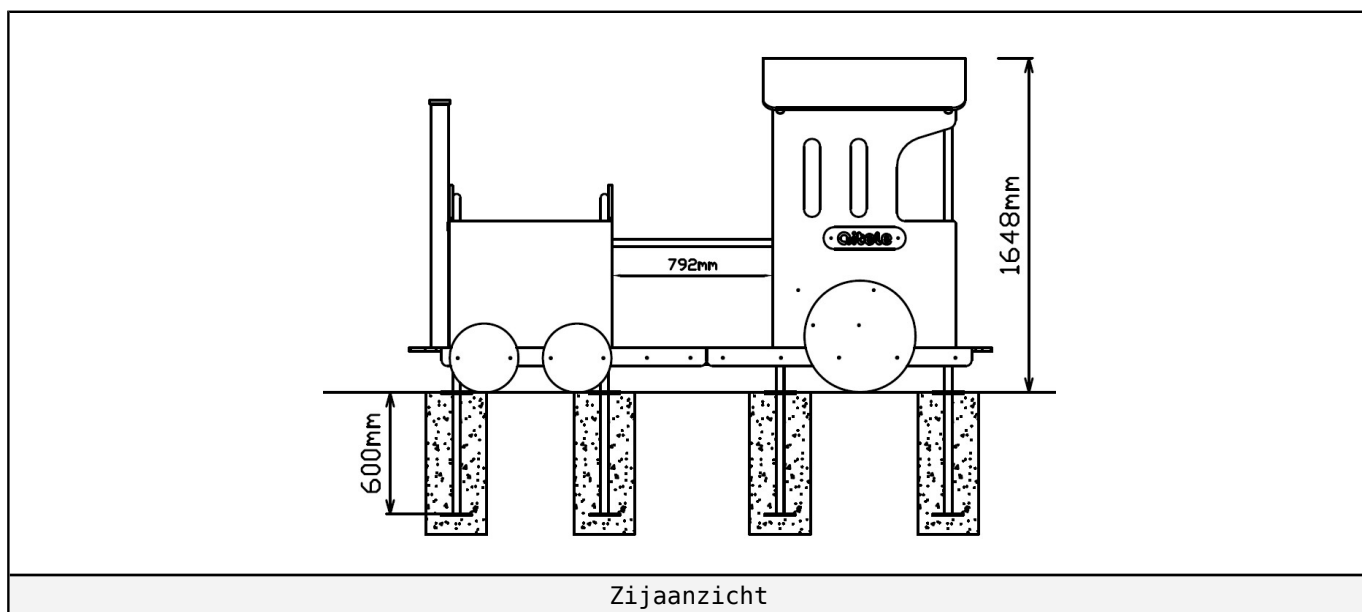

Zijaanzicht

Plattegrond palenplan

U kunt van deze tekening niet afmeten!

Voor de betonfundatie heeft u 25 kg snelbeton per staander nodig.

Houdt u er rekening mee dat de betonfundatie minimaal 400mm onder het maaiveld blijft, zoals op de tekening afgebeeld.

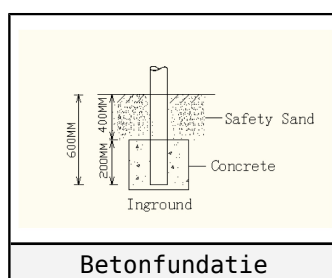
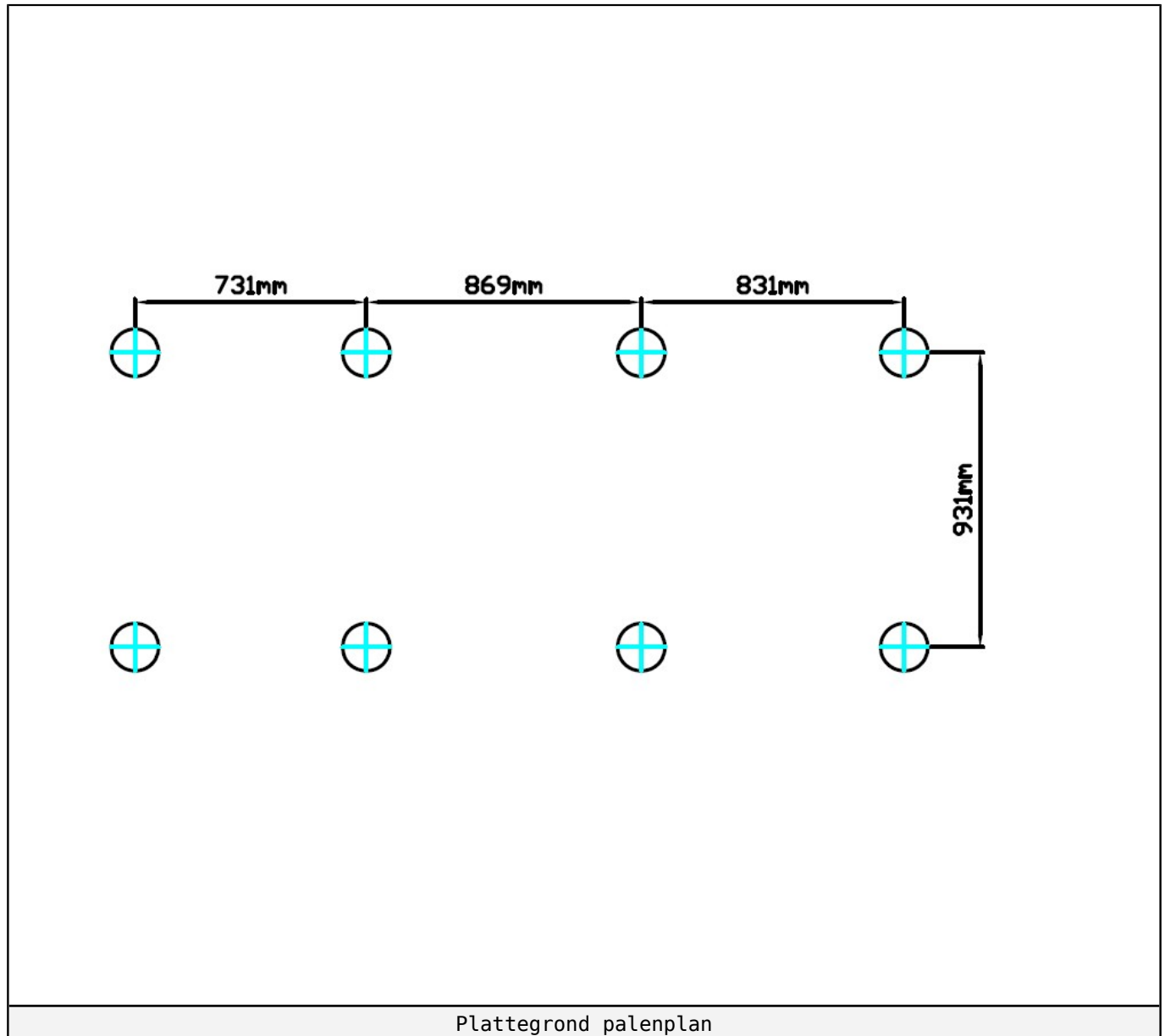

Onderdeel handleidingen

Op de volgende pagina's van dit document vindt u alle individuele onderdelen met bijhorende technische tekeningen en eventuele montage instructies.



1 STUK

Hoofdafmetingen:

Er is geen technische tekening aan dit onderdeel toegevoegd.



8 STUKS

Hoofdafmetingen:

Er is geen technische tekening aan dit onderdeel toegevoegd.



Framedeel 2 Locomotief

2 STUKS

Hoofdafmetingen: 123x10x4 cm

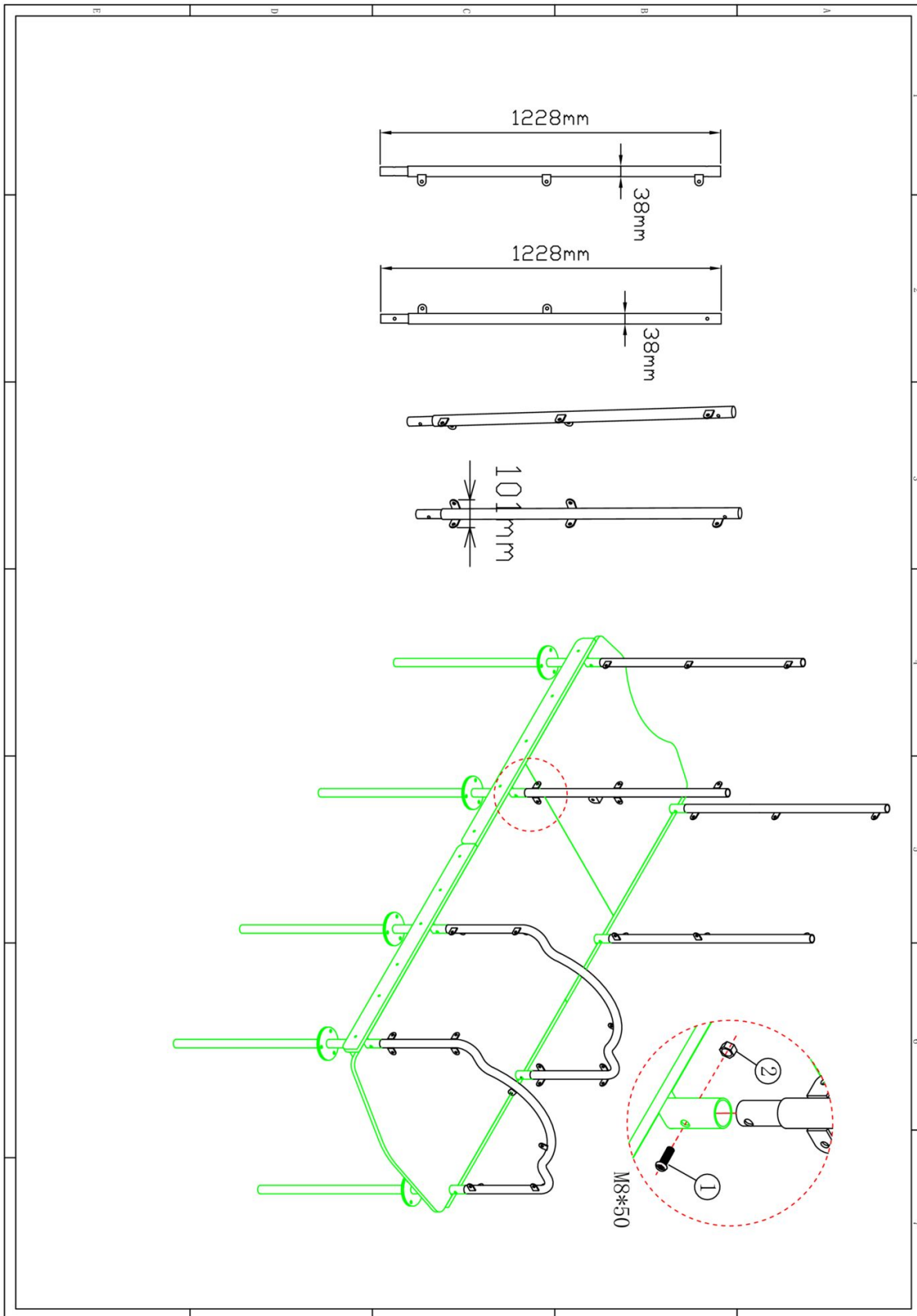



Framedeel 3 Locomotief

2 STUKS

Hoofdafmetingen: 97x78x7 cm

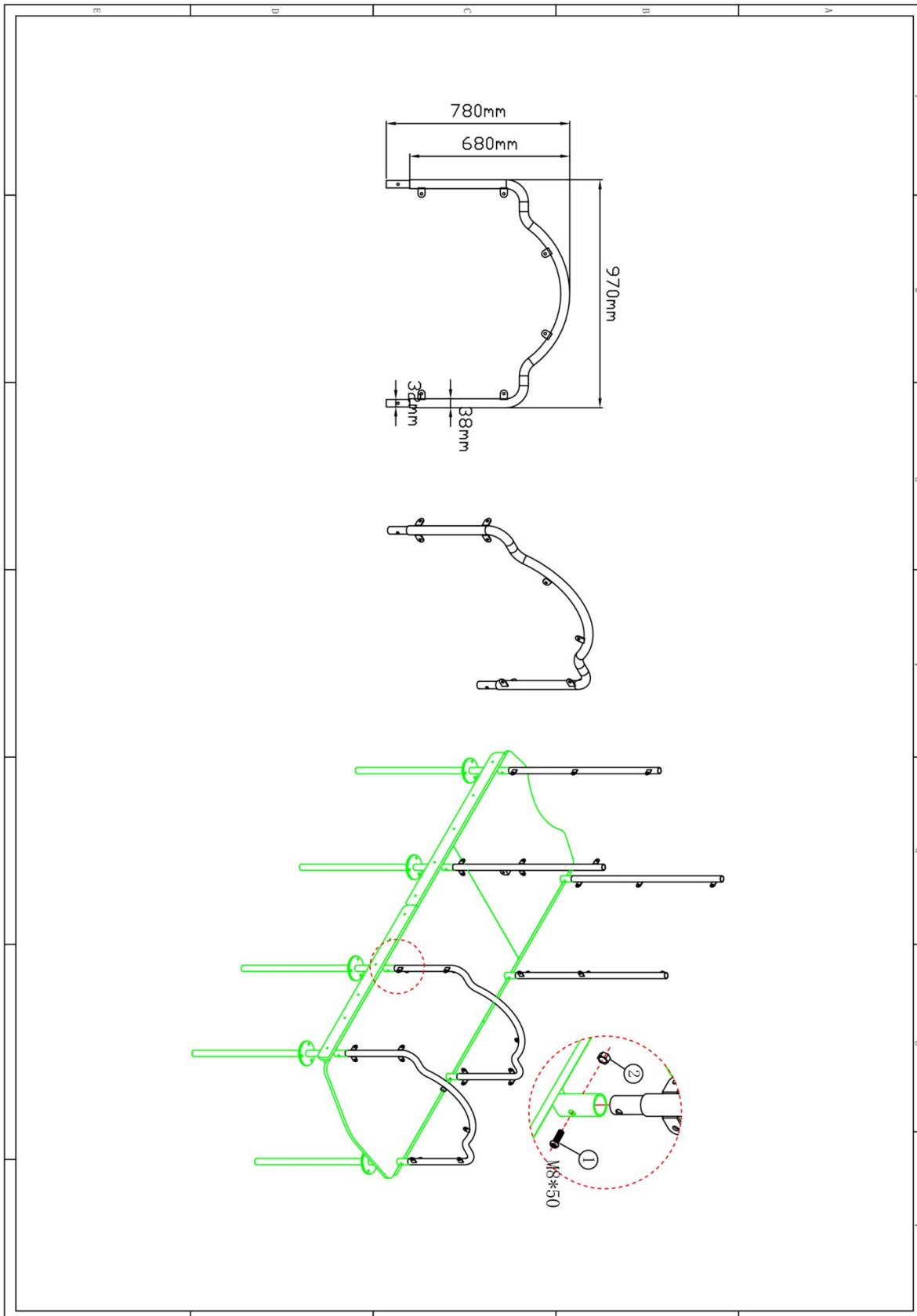



Framedeel 1 Locomotief

2 STUKS

Hoofdafmetingen: 123x7x4 cm

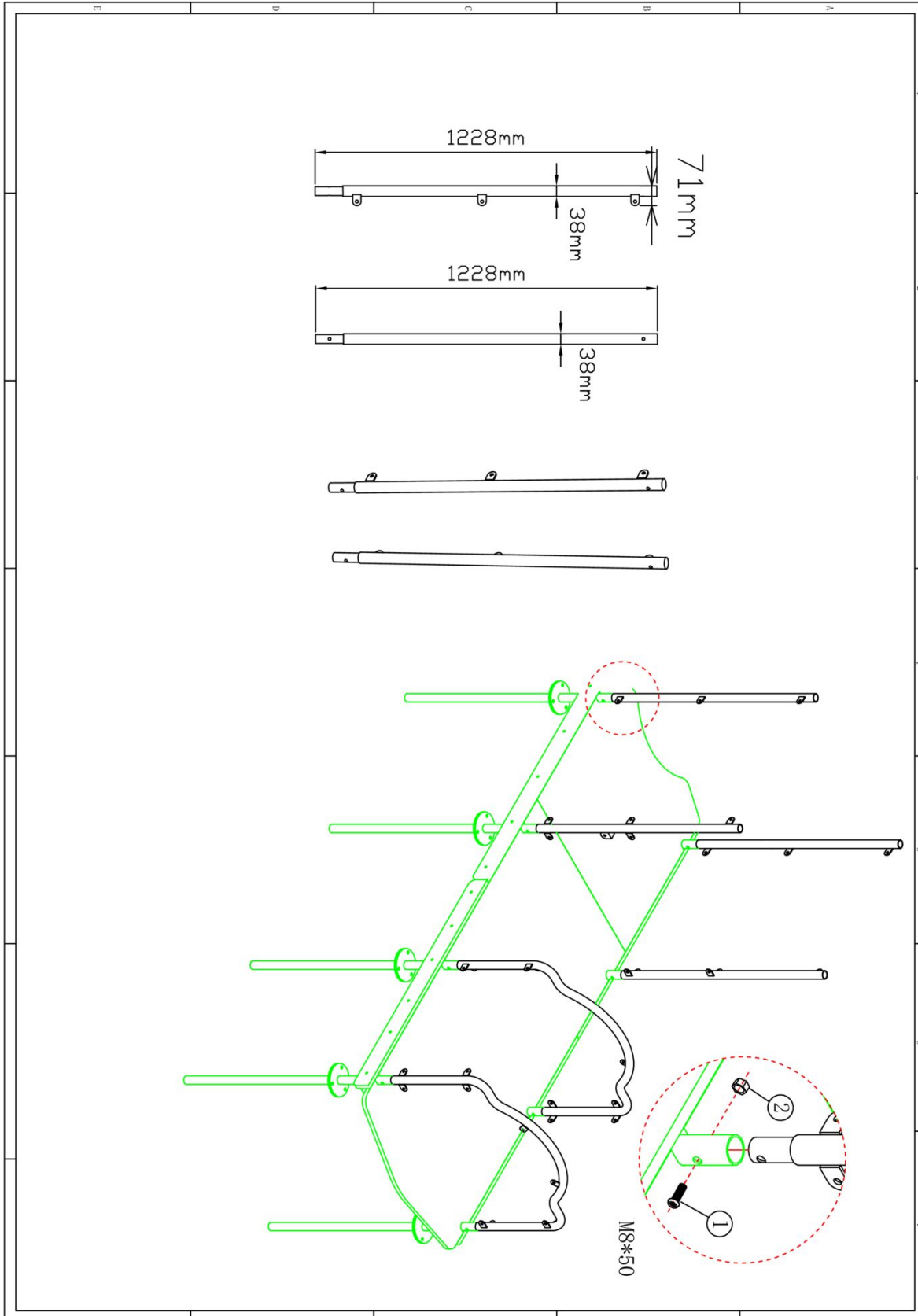

Framedeel 1 Locomotief

STAP 1 van 1

Omschrijving: Bevestiging tussen het onderstel van de locomotief en de framedelen

2 st. Framedeel 1 Locomotief	2 st. Framedeel 2 Locomotief	2 st. Framedeel 3 Locomotief	8 st. Afdekdop M8
8 st. Torx M8X50	8 st. Lock Moer M8		

M8*50

Bevestigings materiaal is per zakje verpakt en bovenstaande afbeelding zit in het zakje

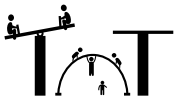

Dak Locomotief

1 STUK

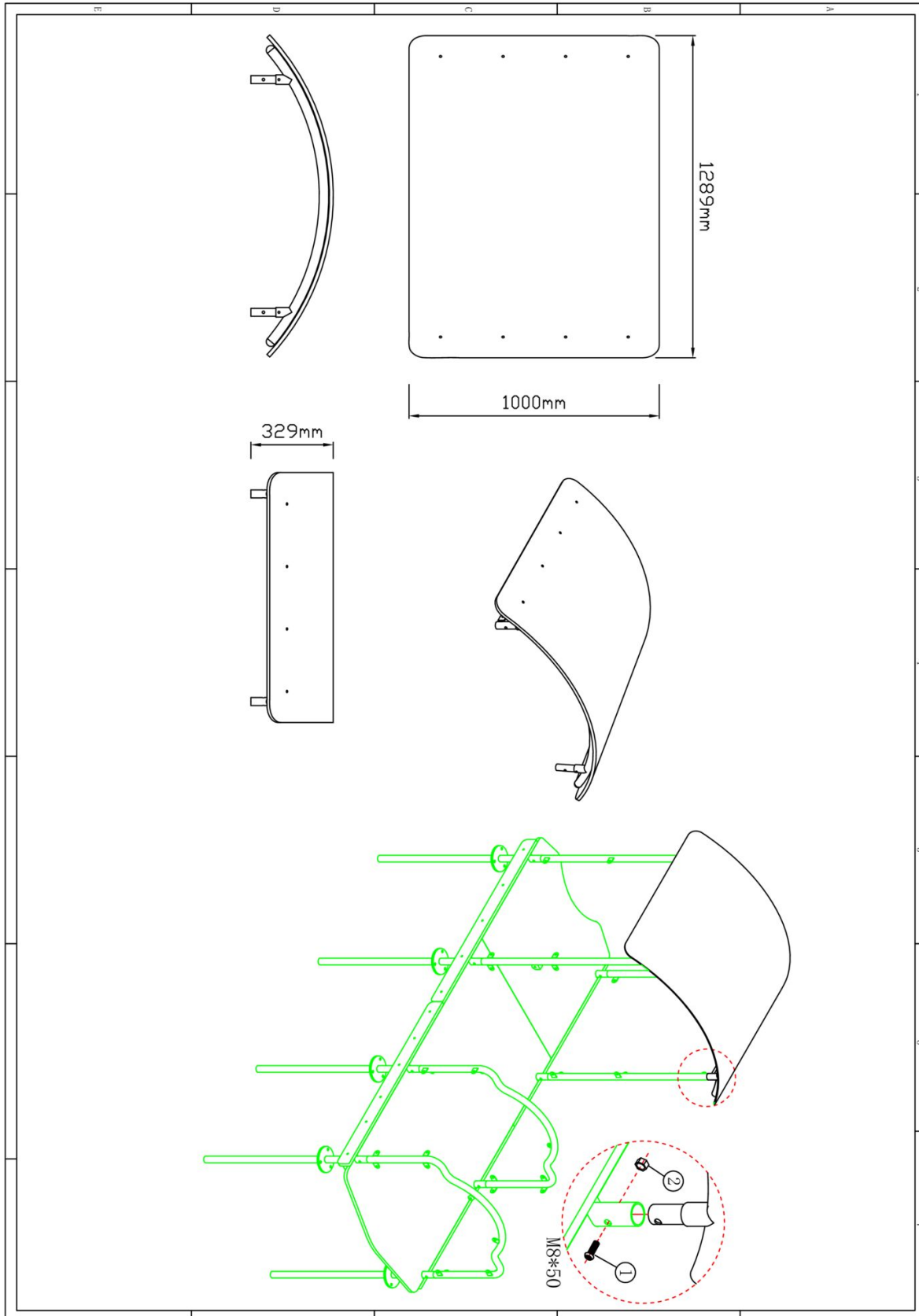

Hoofdafmetingen: 129x100x33 cm



Dak Locomotief

STAP 1 van 1

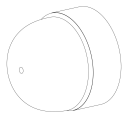
Omschrijving: Bevestiging tussen het dak en het locomotief frame

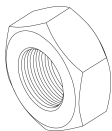
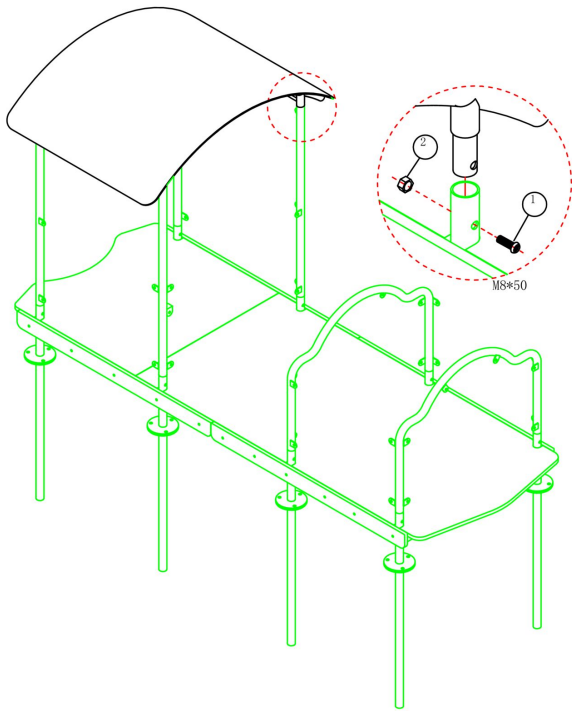
1 st. Dak Locomotief	4 st. Afdekdop M8	4 st. Torx M8X50	4 st. Lock Moer M8
			
			
Bevestigings materiaal is per zakje verpakt en bovenstaande afbeelding zit in het zakje			



paneel 1 (Locomotief)

2 STUKS

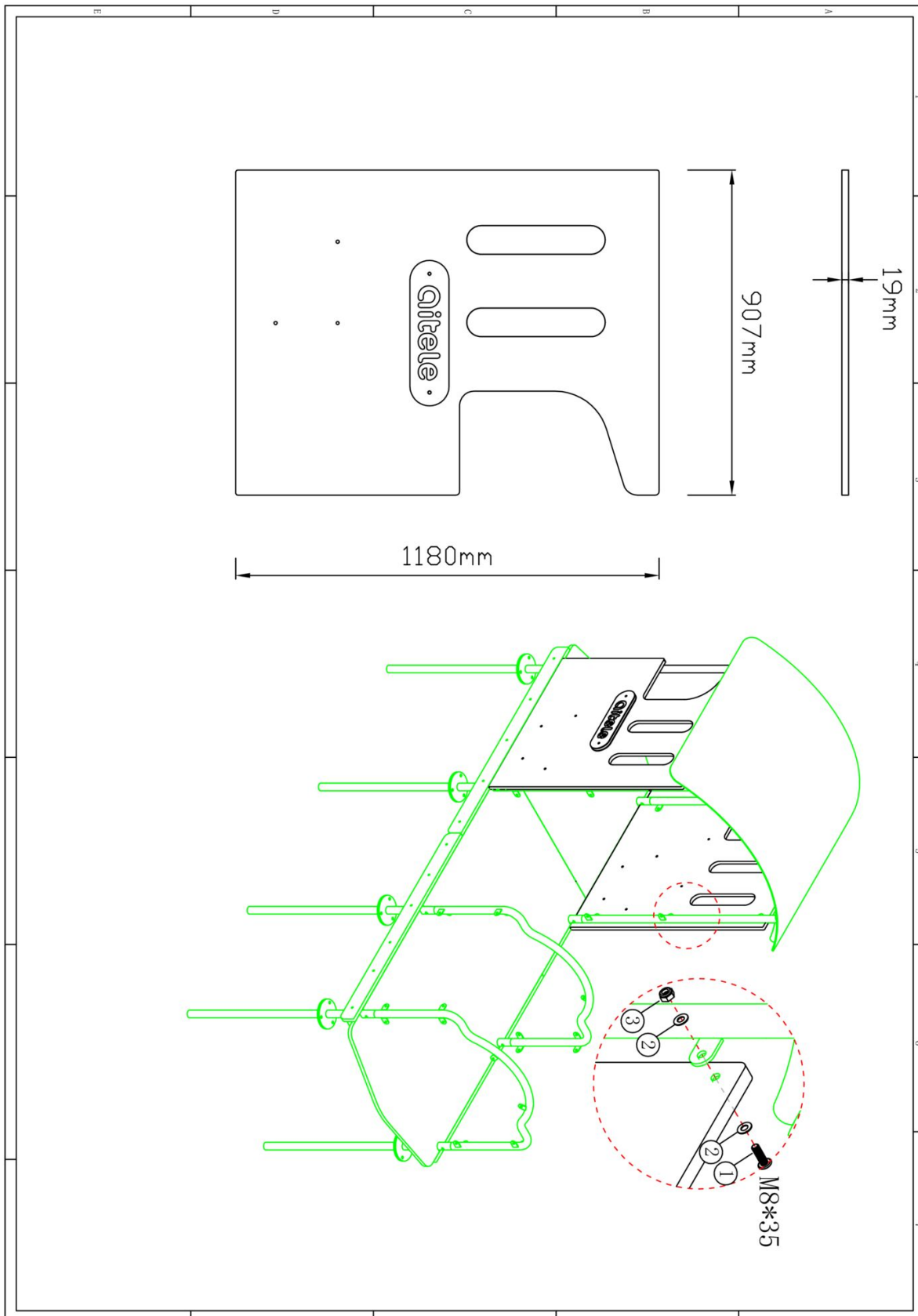

Hoofdafmetingen: 118x91x2 cm



paneel 1 (Locomotief)

STAP 1 van 1

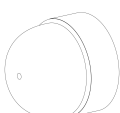
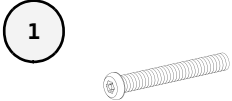
Omschrijving: Bevestiging tussen het locomotief frame en het paneel

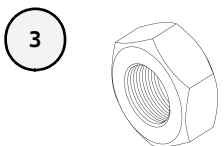
2 st. paneel 1 (Locomotief)	6 st. Afdekdop M8	6 st. Torx M8X35	12 st. Ring M8 (klein)
			
6 st. Lock Moer M8			
			

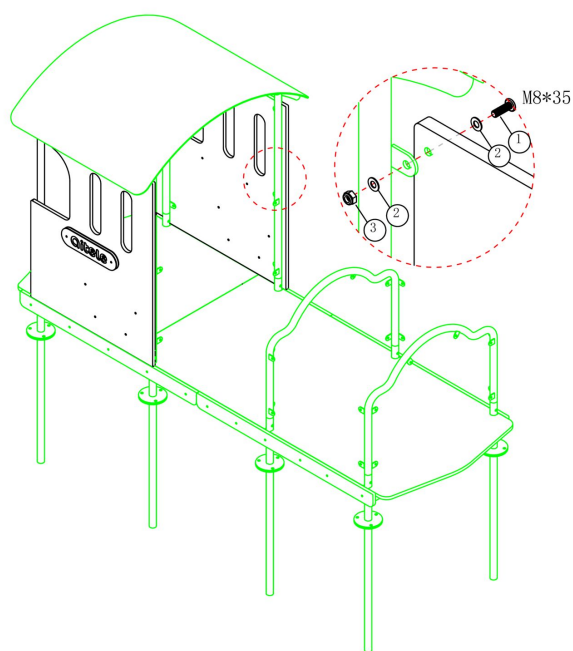

Bevestigings materiaal is per zakje verpakt en bovenstaande afbeelding zit in het zakje



Bank paneel 2 (Locomotief)

4 STUKS

Hoofdafmetingen: 25x25x2 cm

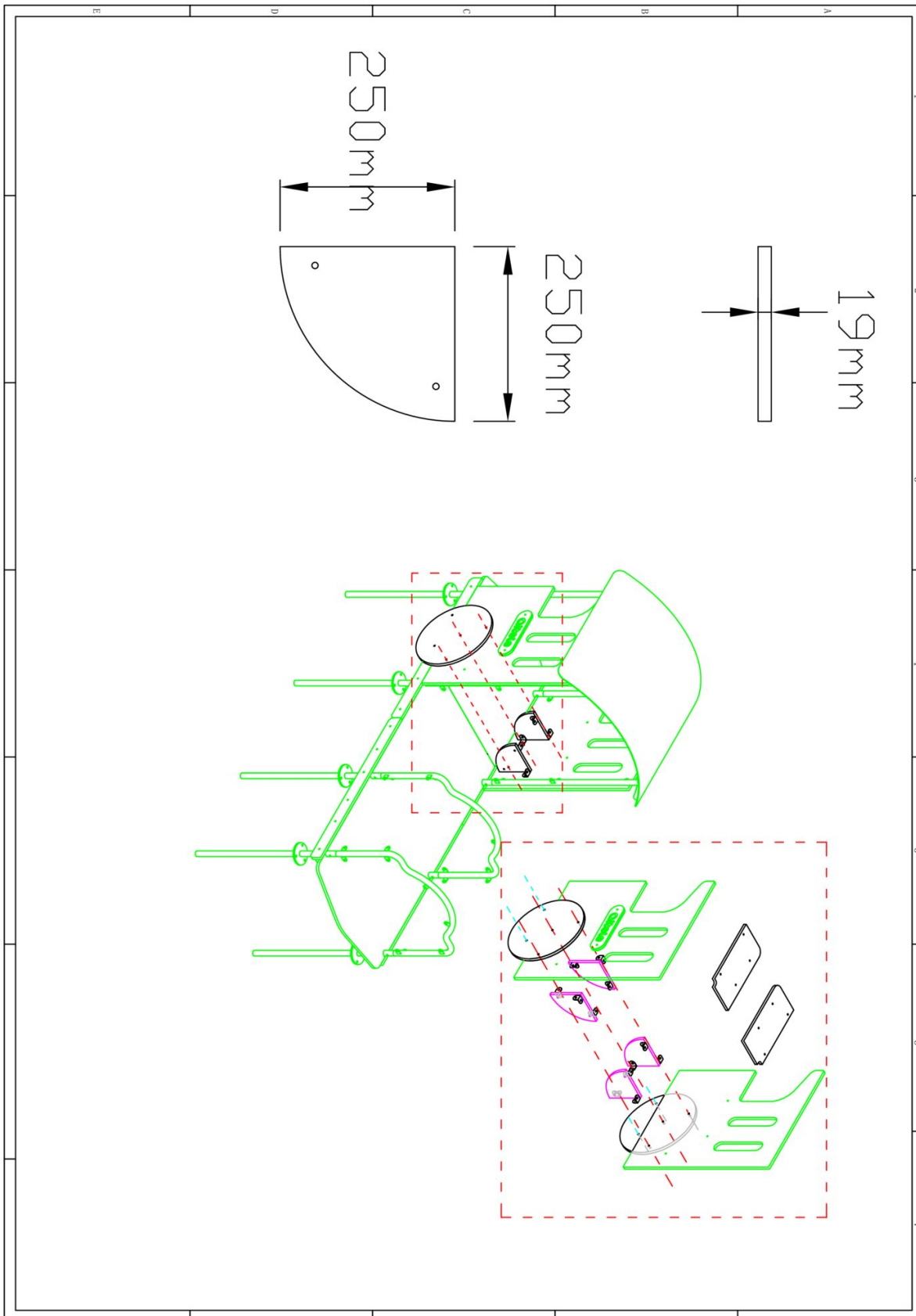

Locomotief wiel (groot)

2 STUKS



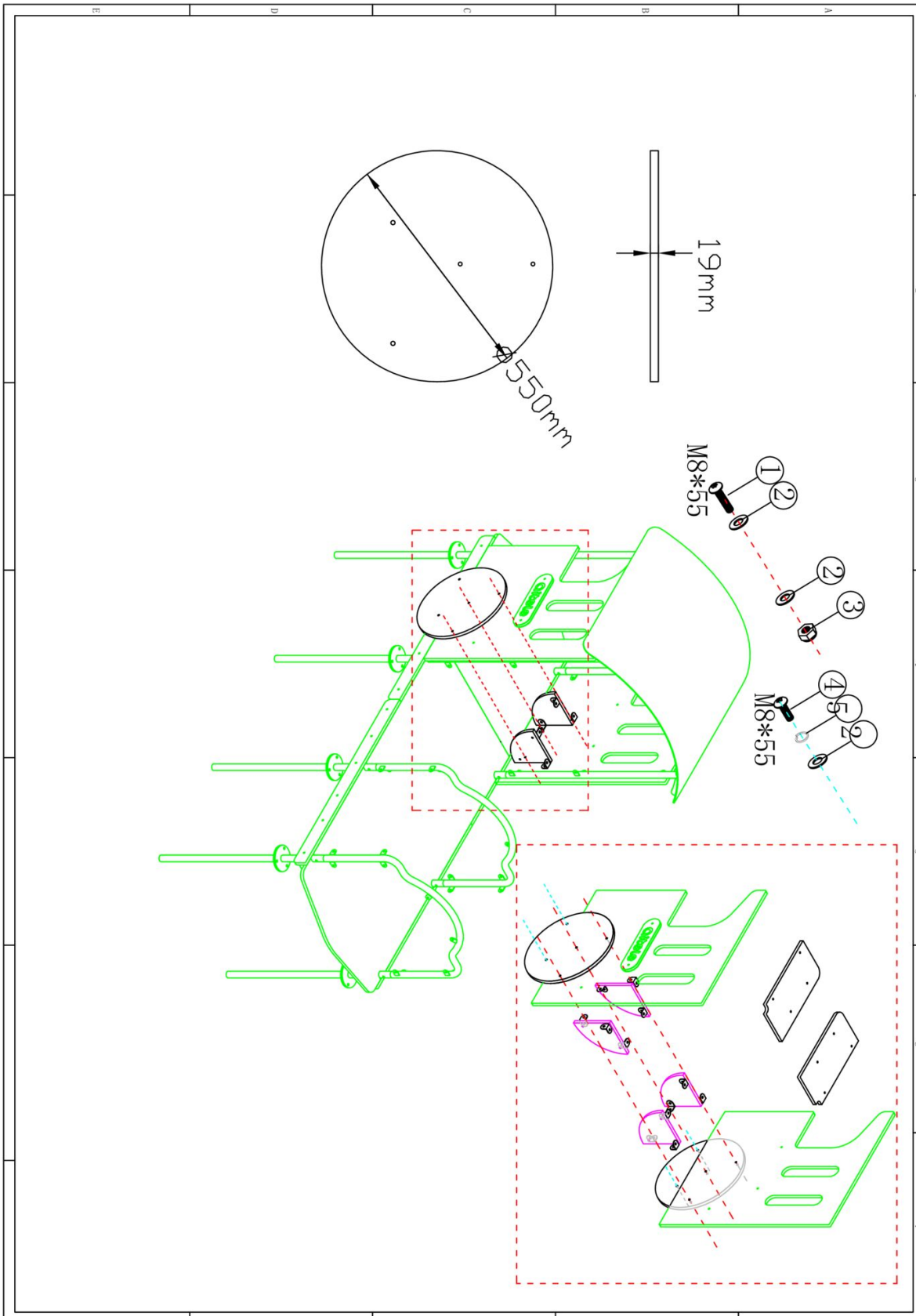

Hoofdafmetingen: $\varnothing 55 \times 2$ cm

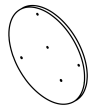

Locomotief wiel (groot)

STAP 1 van 1

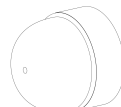
Omschrijving: Bevestiging tussen het wiel en de locomotief/bankpaneel

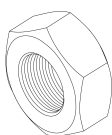
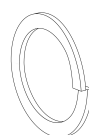
1 st. Locomotief wiel (groot)	1 st. Bank paneel 2 (Locomotief)	2 st. Bevestigingshoek	2 st. Afdekdop M8
			
4 st. Torx M8X55	6 st. Ring M8 (klein)	2 st. Lock Moer M8	2 st. Veerring M8
1 	2 	3 	4 

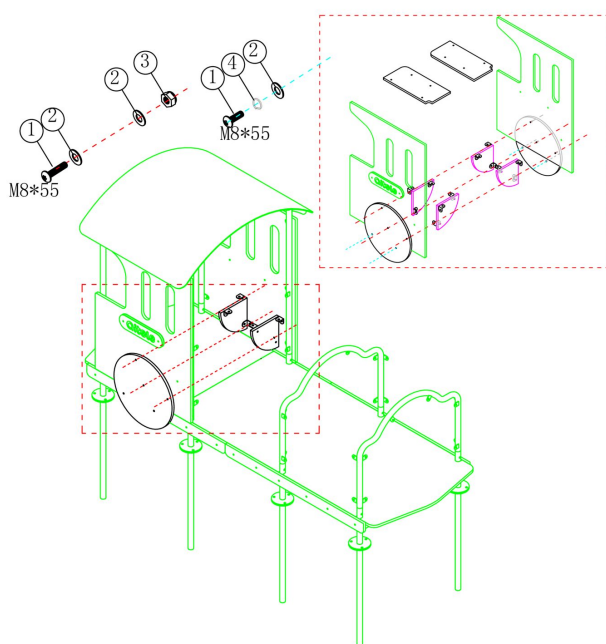

Bevestigings materiaal is per zakje verpakt en bovenstaande afbeelding zit in het zakje



Bank paneel 1 (Locomotief)

2 STUKS



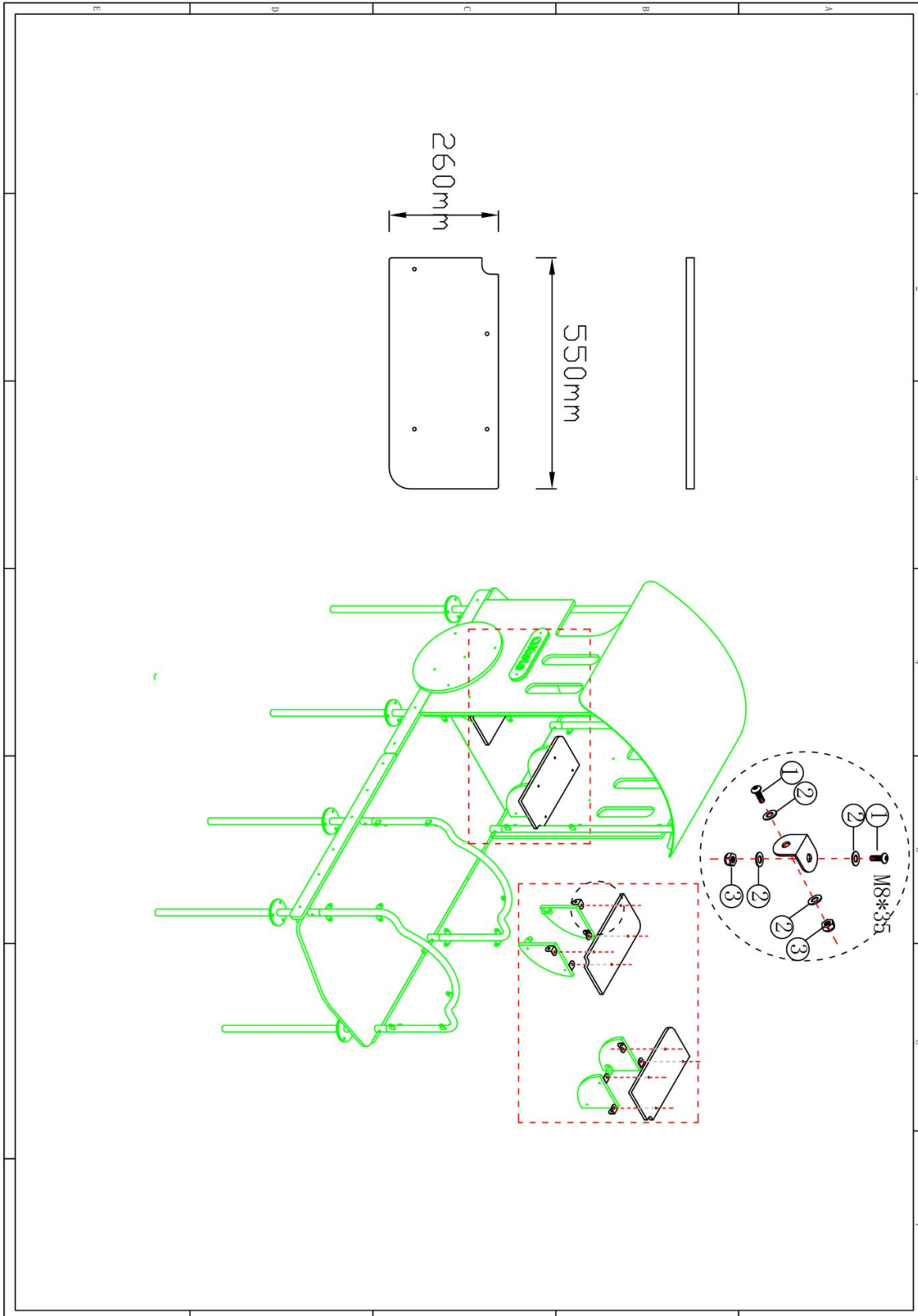

Hoofdafmetingen: 55x26x2 cm

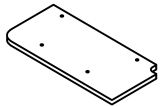

Bank paneel 1 (Locomotief)

STAP 1 van 1

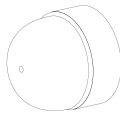
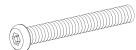
Omschrijving: Bevestiging tussen beide bankpanelen

1 st. Bank paneel 1 (Locomotief)	4 st. Bevestigingshoek	8 st. Afdekdop M8	8 st. Torx M8X35
			 1
16 st. Ring M8 (klein)	8 st. Lock Moer M8		
 2	 3		

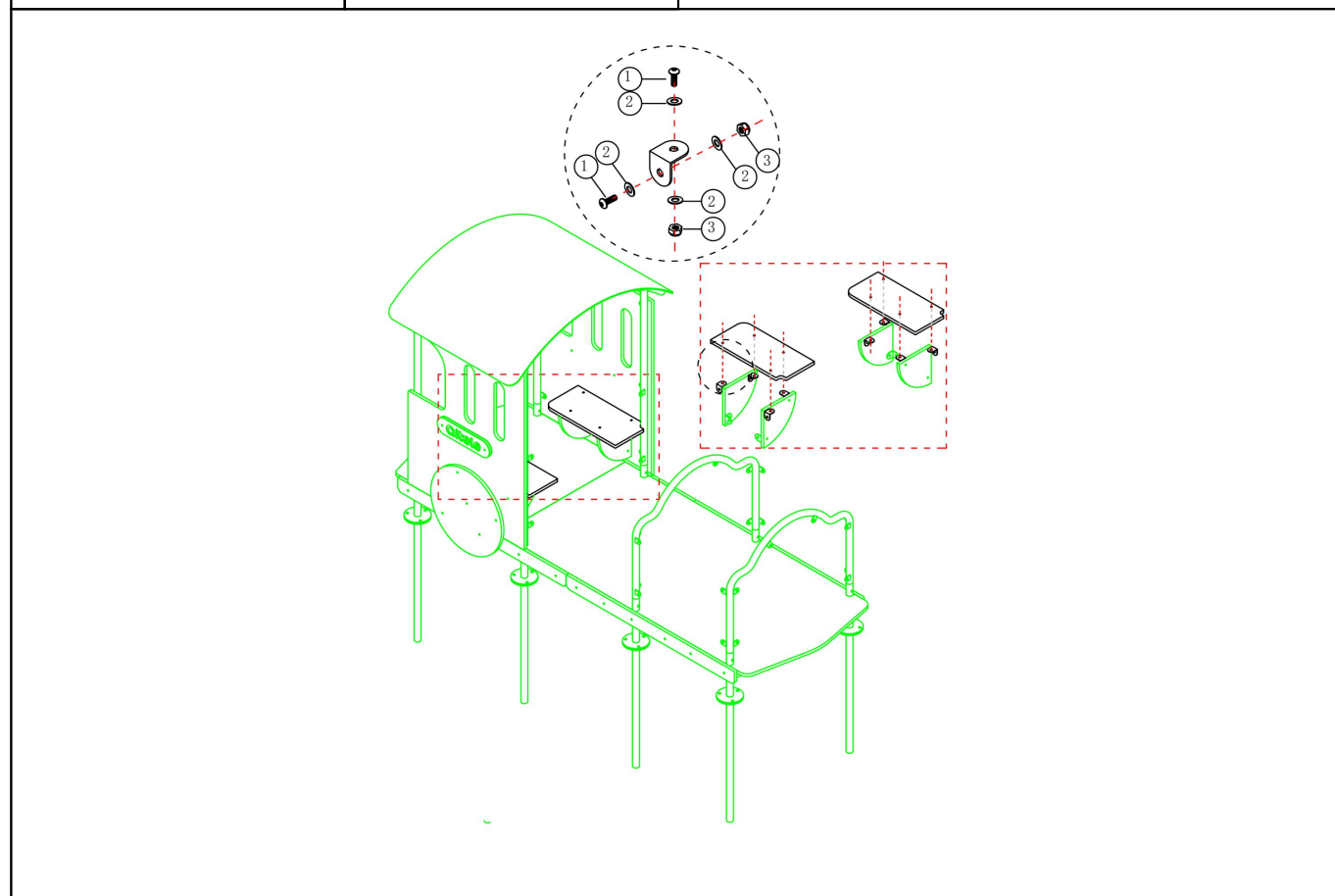

Bevestigings materiaal is per zakje verpakt en bovenstaande afbeelding zit in het zakje



Paneel 2 (Locomotief)

2 STUKS

Hoofdafmetingen: 81x62x2 cm

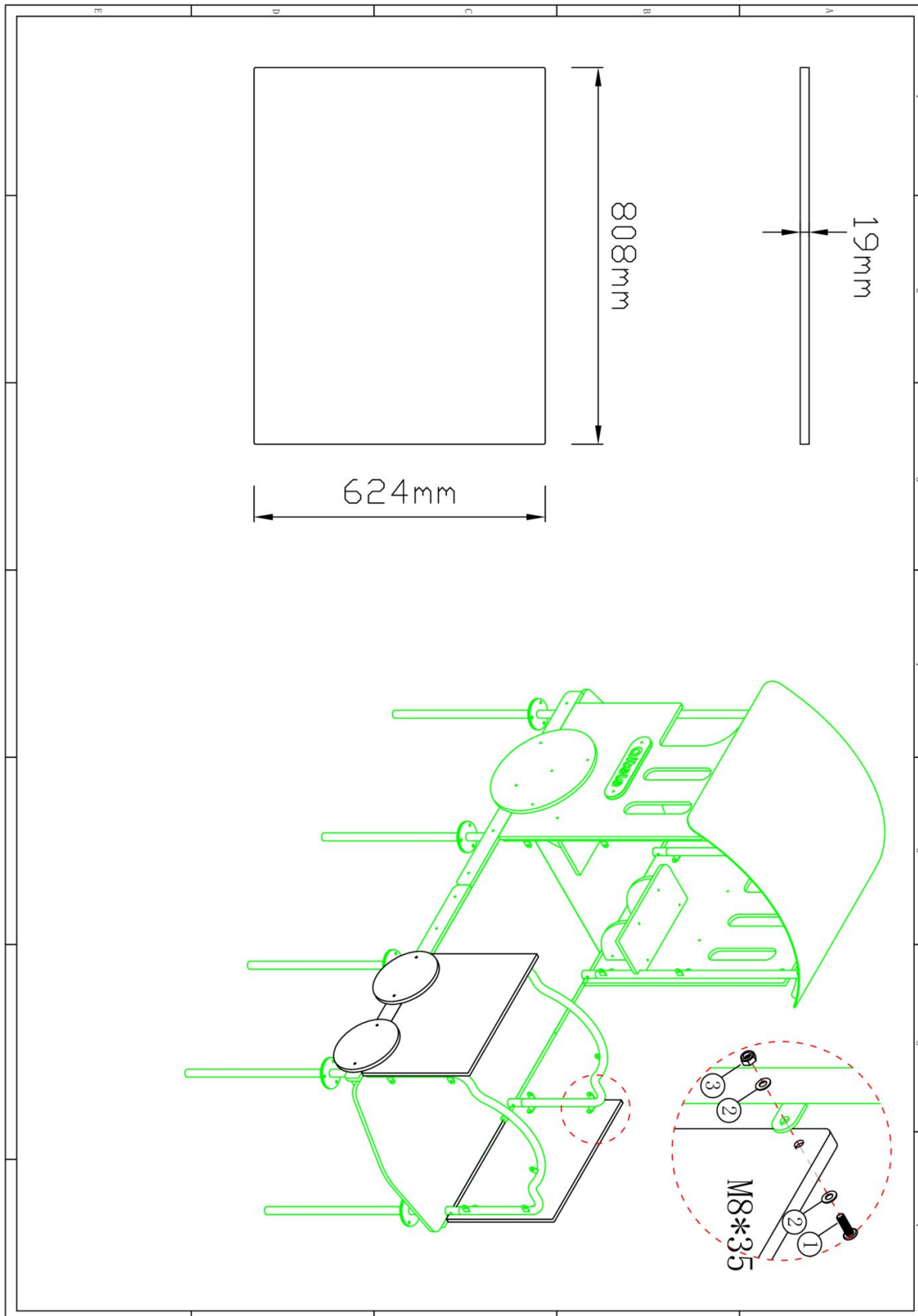

Paneel 2 (Locomotief)

STAP 1 van 1

Omschrijving: Bevestiging tussen het paneel en het locomotief frame

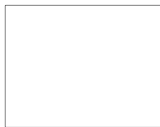
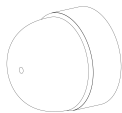
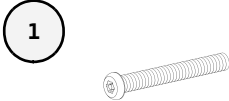
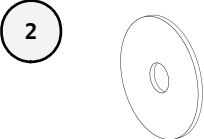
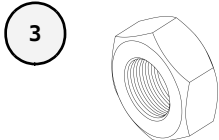
1 st. Paneel 2 (Locomotief)	4 st. Afdekdop M8	4 st. Torx M8X35	8 st. Ring M8 (klein)
			
4 st. Lock Moer M8			
			

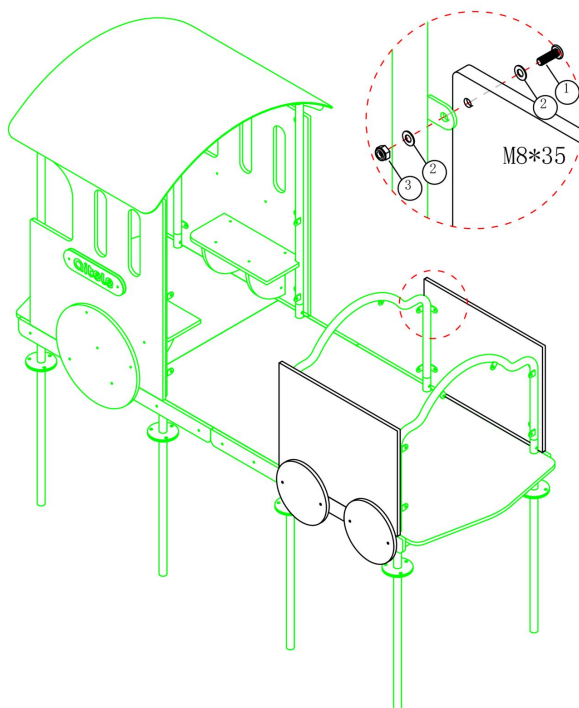

Bevestigings materiaal is per zakje verpakt en bovenstaande afbeelding zit in het zakje

Wiel Locomotief (klein)

4 STUKS

Hoofdafmetingen: Ø 34x2 cm

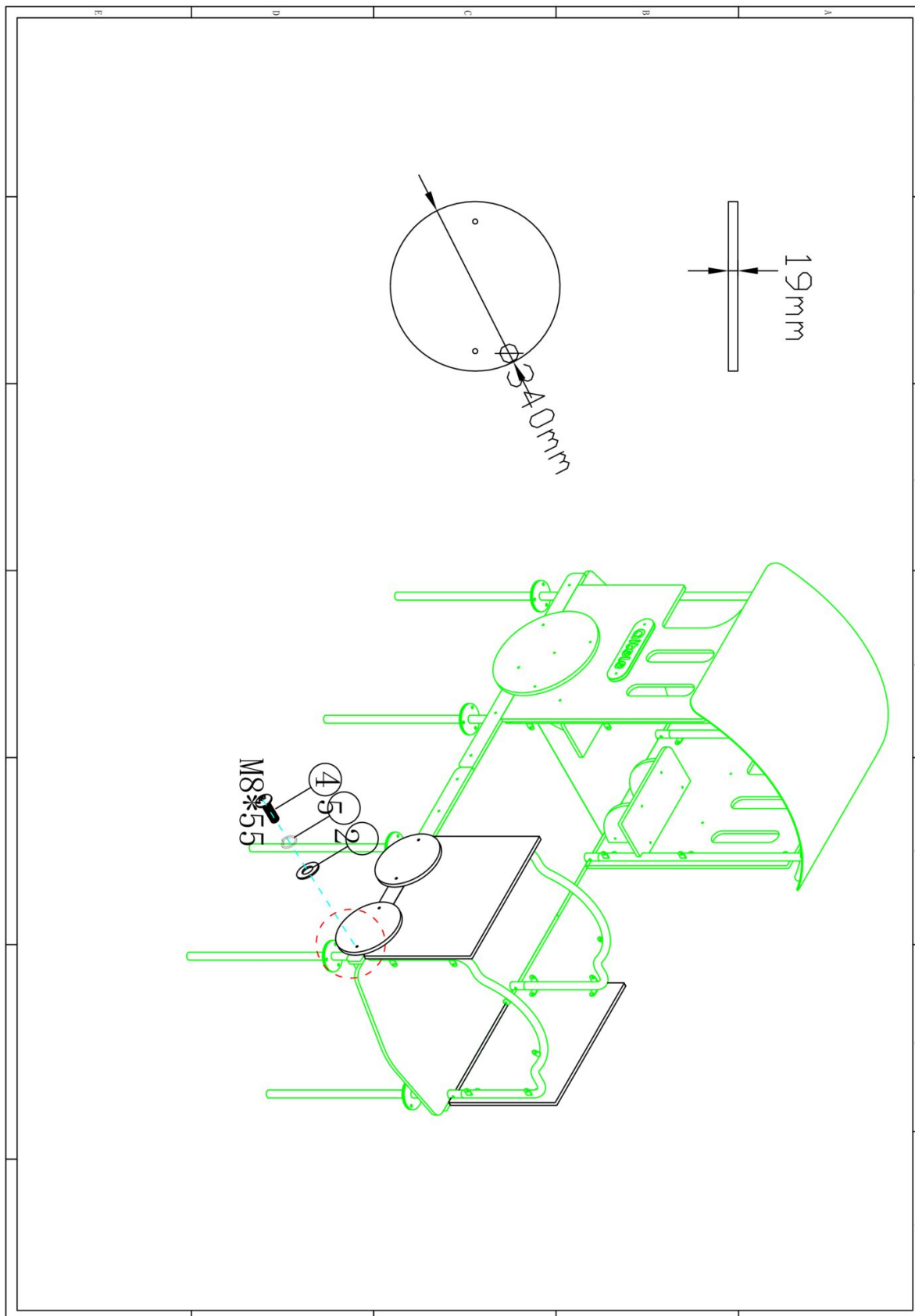

Wiel Locomotief (klein)

STAP 1 van 1

Omschrijving: Bevestiging tussen het wiel en het frame

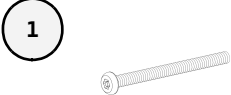
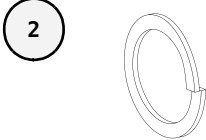
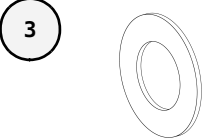
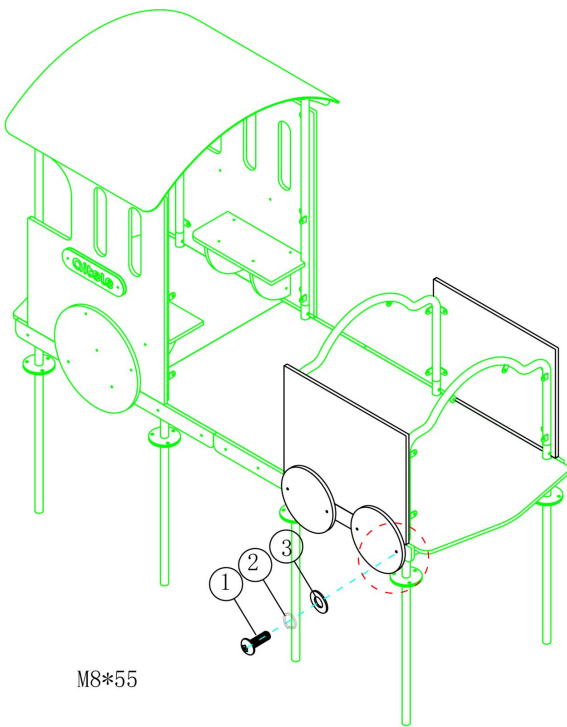
1 st. Wiel Locomotief (klein)	2 st. Torx M8X55	2 st. Veerring M8	2 st. Ring M8 (middel)
			
 <p>M8*55</p>			
Bevestigings materiaal is per zakje verpakt en bovenstaande afbeelding zit in het zakje			



Paneel 3 (Locomotief)

1 STUK

Hoofdafmetingen: 97x80x2 cm

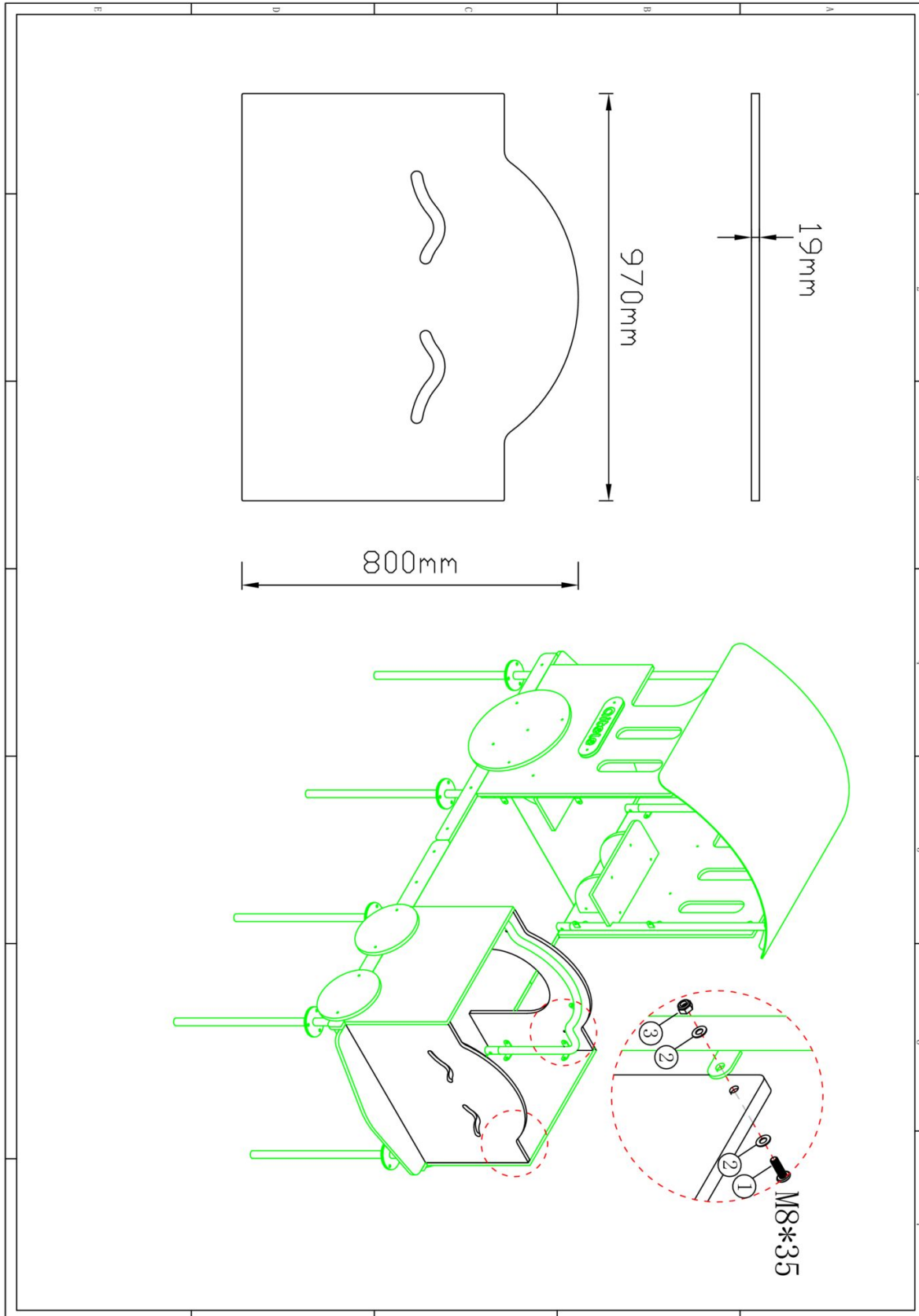

Paneel 3 (Locomotief)

STAP 1 van 1

Omschrijving: Bevestiging tussen het paneel en het locomotief frame

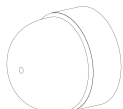
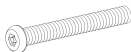
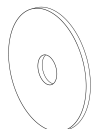
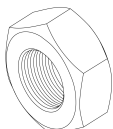
1 st. Paneel 3 (Locomotief)	6 st. Afdekdop M8	6 st. Torx M8X35	12 st. Ring M8 (klein)
		1 	2 
6 st. Lock Moer M8			
3 			

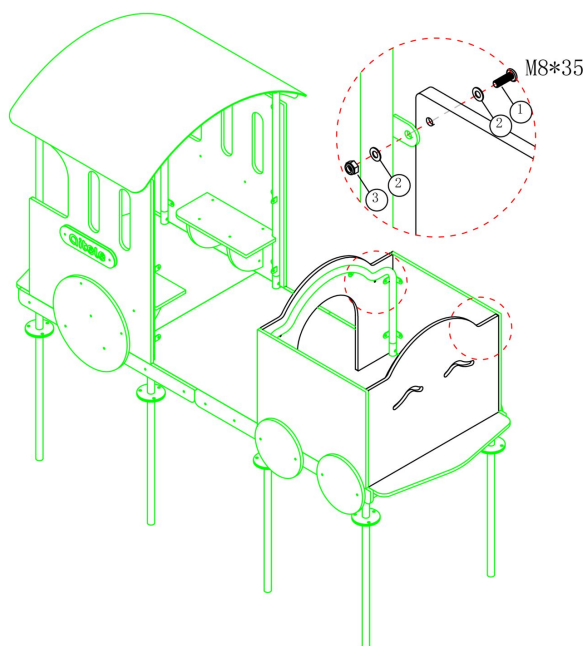

Bevestigings materiaal is per zakje verpakt en bovenstaande afbeelding zit in het zakje



Paneel 4 (Locomotief)

1 STUK

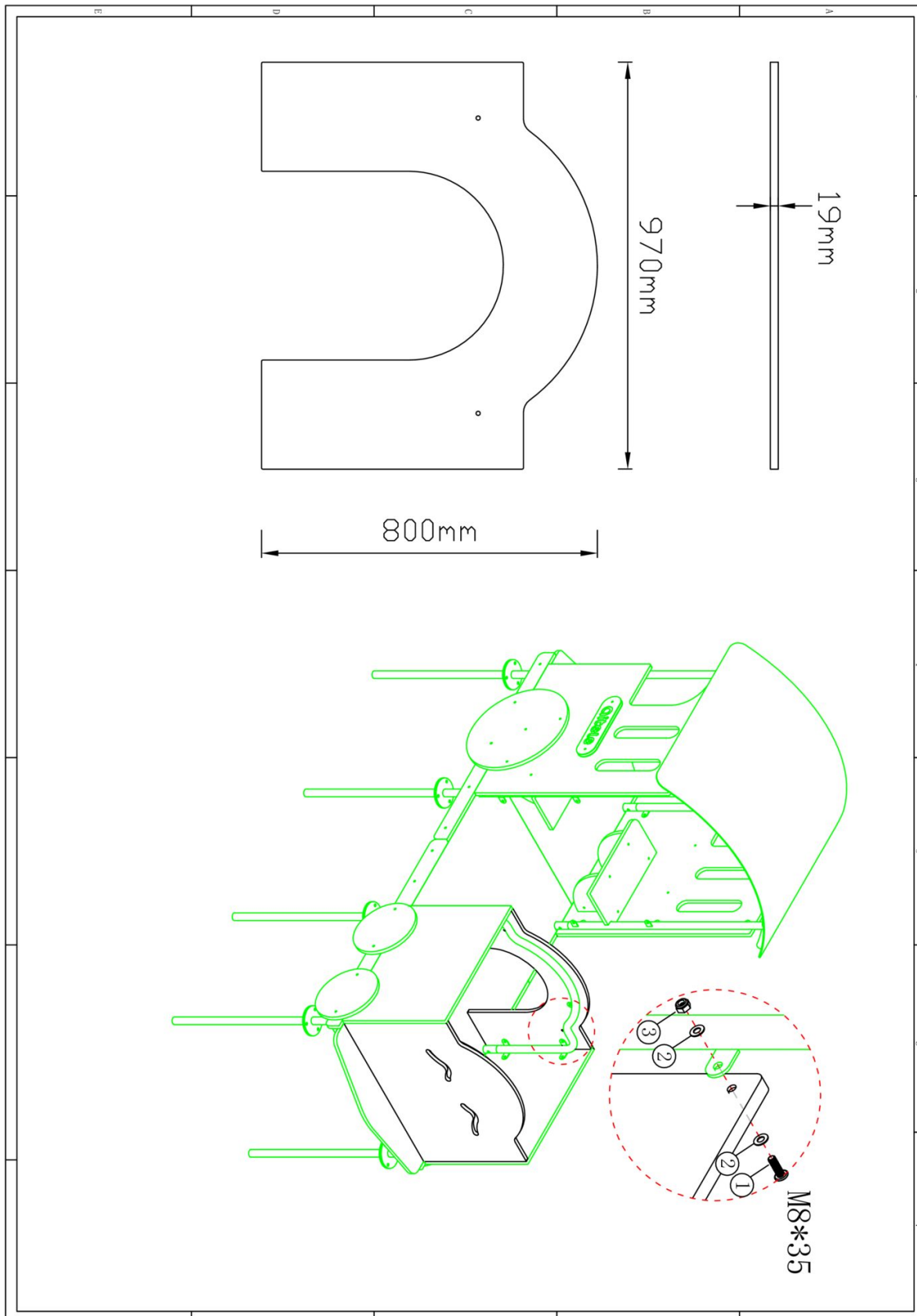

Hoofdafmetingen: 97x80x2 cm



Paneel 4 (Locomotief)

STAP 1 van 1

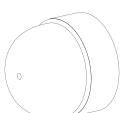
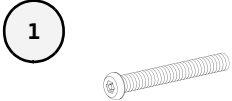
Omschrijving: Bevestiging tussen het paneel en het locomotief frame

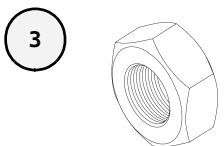
1 st. Paneel 4 (Locomotief)	6 st. Afdekdop M8	6 st. Torx M8X35	12 st. Ring M8 (klein)
			
6 st. Lock Moer M8			
			

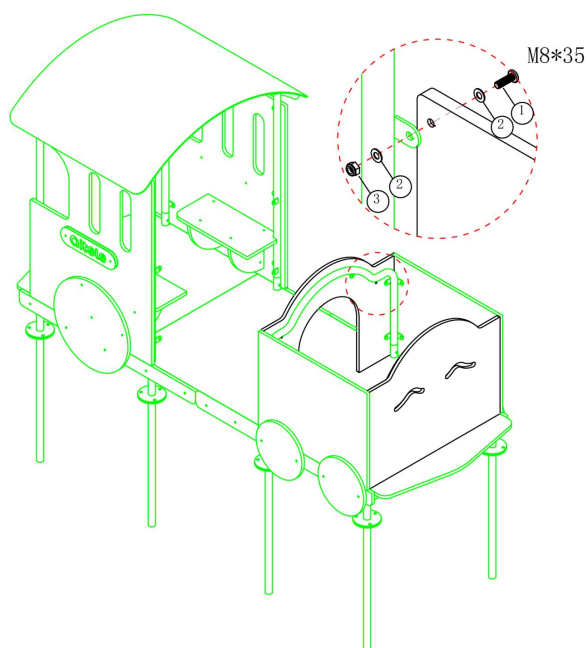

Bevestigings materiaal is per zakje verpakt en bovenstaande afbeelding zit in het zakje

Paneel 5 (Locomotief)

1 STUK

Hoofdafmetingen: 97x80x2 cm

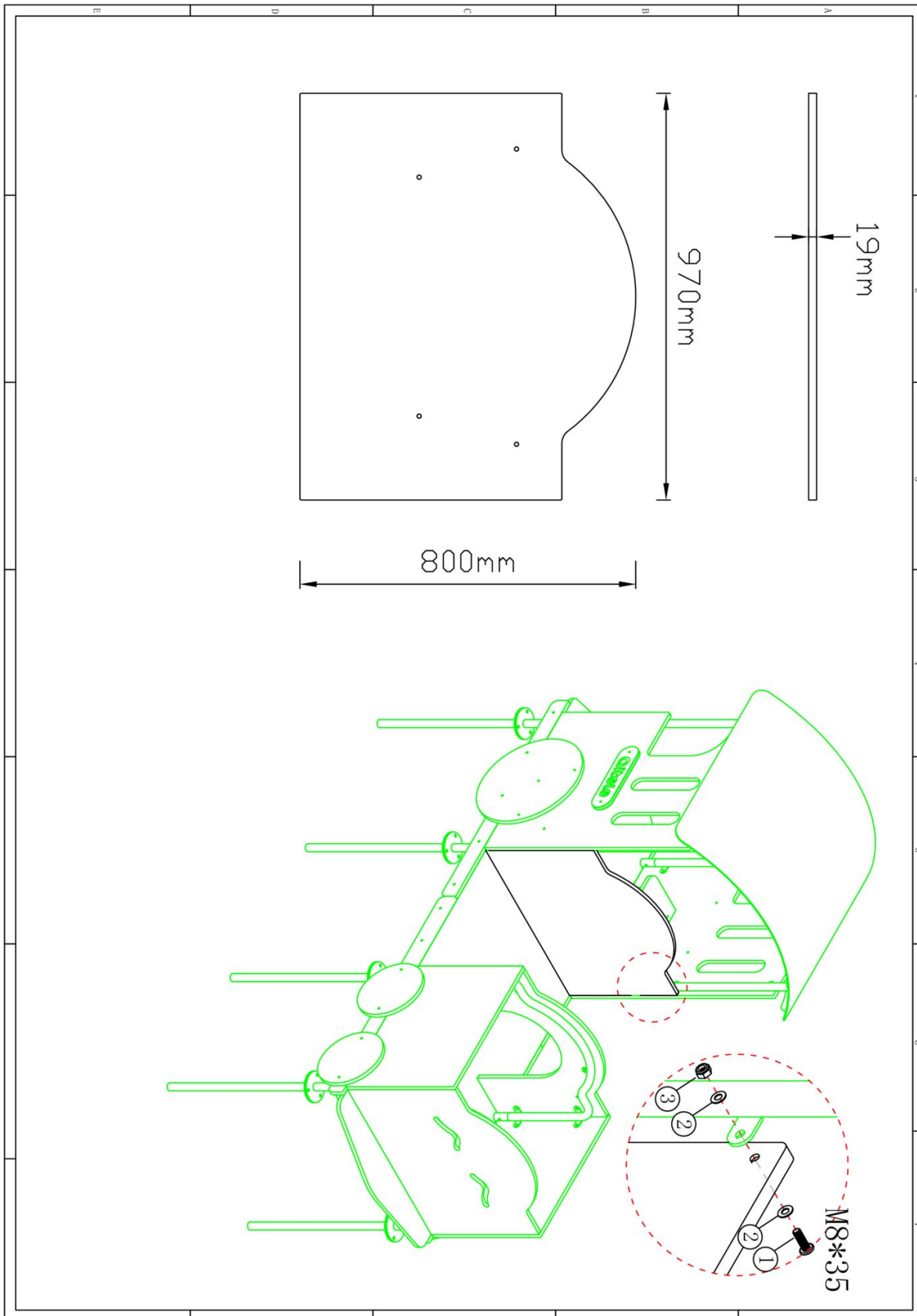

Paneel 5 (Locomotief)

STAP 1 van 1

Omschrijving: Bevestiging tussen het paneel en het locomotief frame

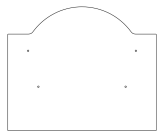
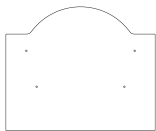
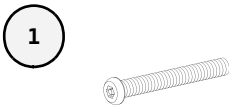
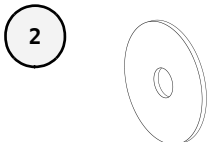
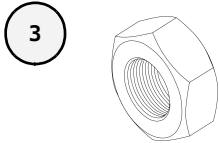
1 st. Paneel 5 (Locomotief)	4 st.	4 st. Torx M8X35	8 st. Ring M8 (klein)
			
4 st. Lock Moer M8			
			

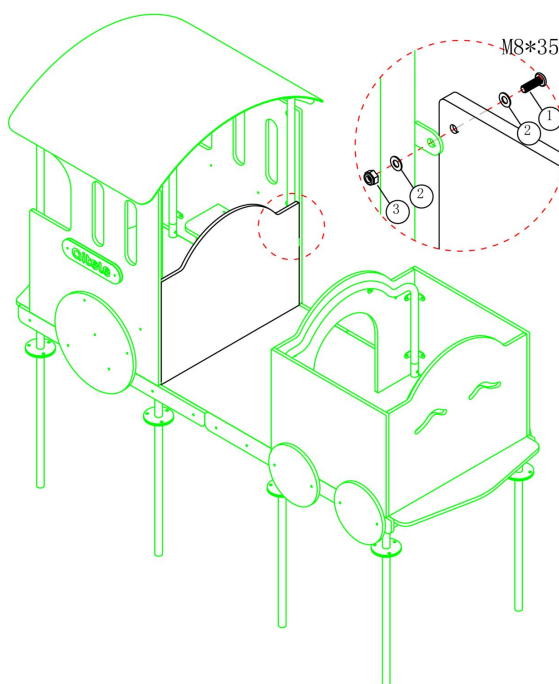

Bevestigings materiaal is per zakje verpakt en bovenstaande afbeelding zit in het zakje



Locomotief stang

2 STUKS

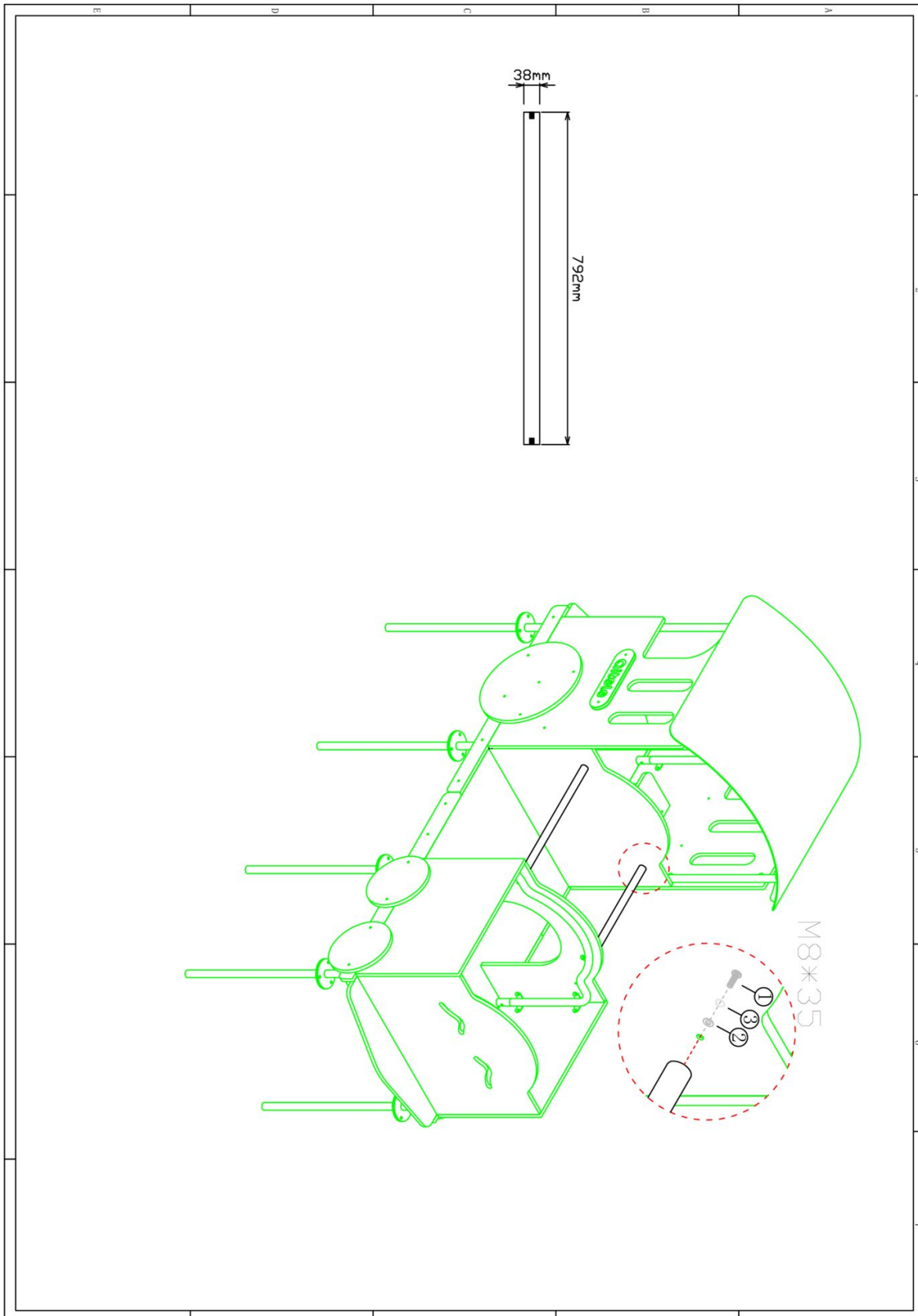

Hoofdafmetingen: 79x4 cm



Locomotief stang

STAP 1 van 1

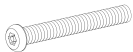
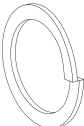
Omschrijving: Bevestiging tussen de stang en panelen

1 st. Locomotief stang	2 st. Torx M8X35	2 st. Veerring M8	2 st. Ring M8 (middel)
			

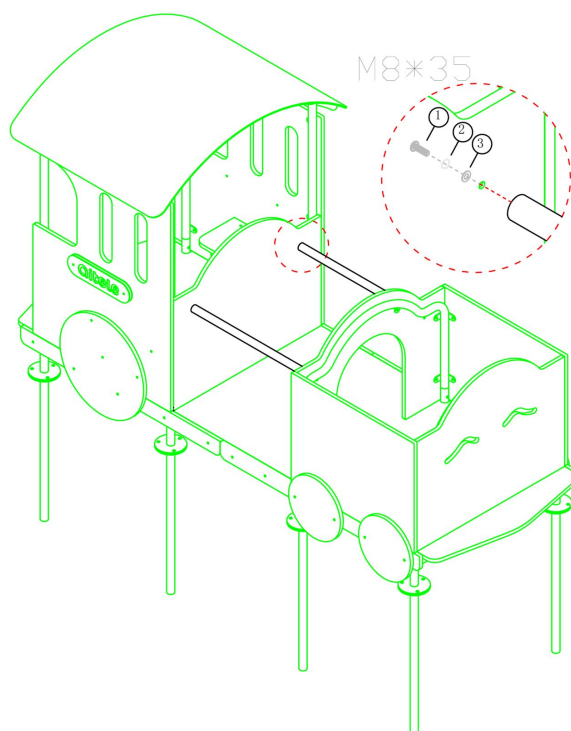

Bevestigings materiaal is per zakje verpakt en bovenstaande afbeelding zit in het zakje



Schoorsteen Locomotief

1 STUK

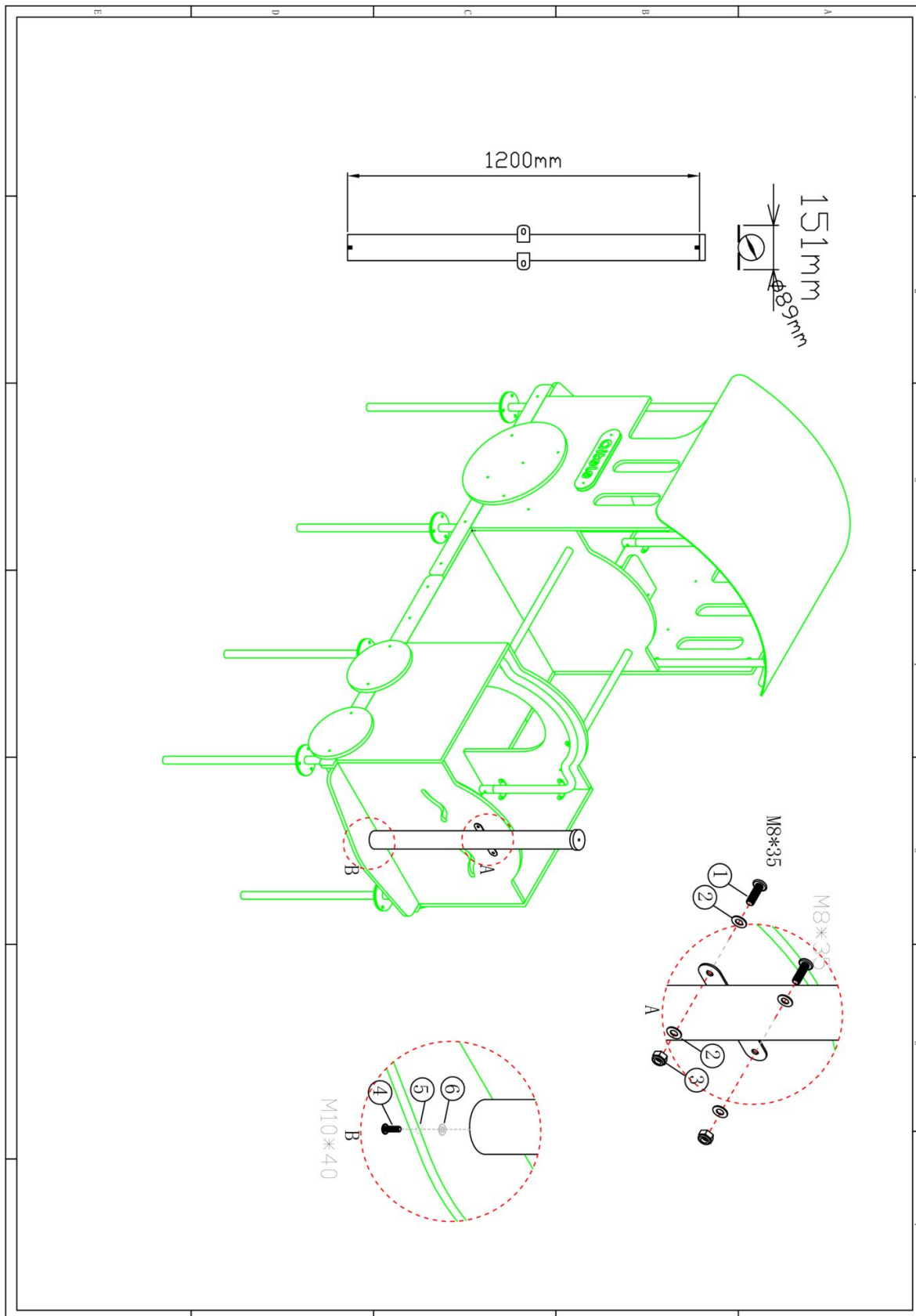

Hoofdafmetingen: 120x15 cm



Schoorsteen Locomotief

STAP 1 van 1

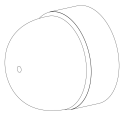
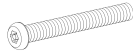
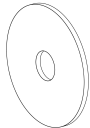
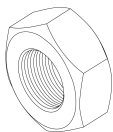
Omschrijving: Bevestiging tussen de schoorsteen en de locomotief

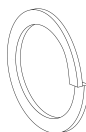
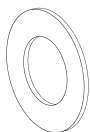
1 st.	2 st. Afdekdop M8	2 st. Torx M8X35	4 st. Ring M8 (klein)
		① 	② 
2 st. Lock Moer M8	1 st. Torx M10X40	1 st. Veerring M10	1 st. Ring M10 (middel)
③ 	④ 	⑤ 	⑥ 

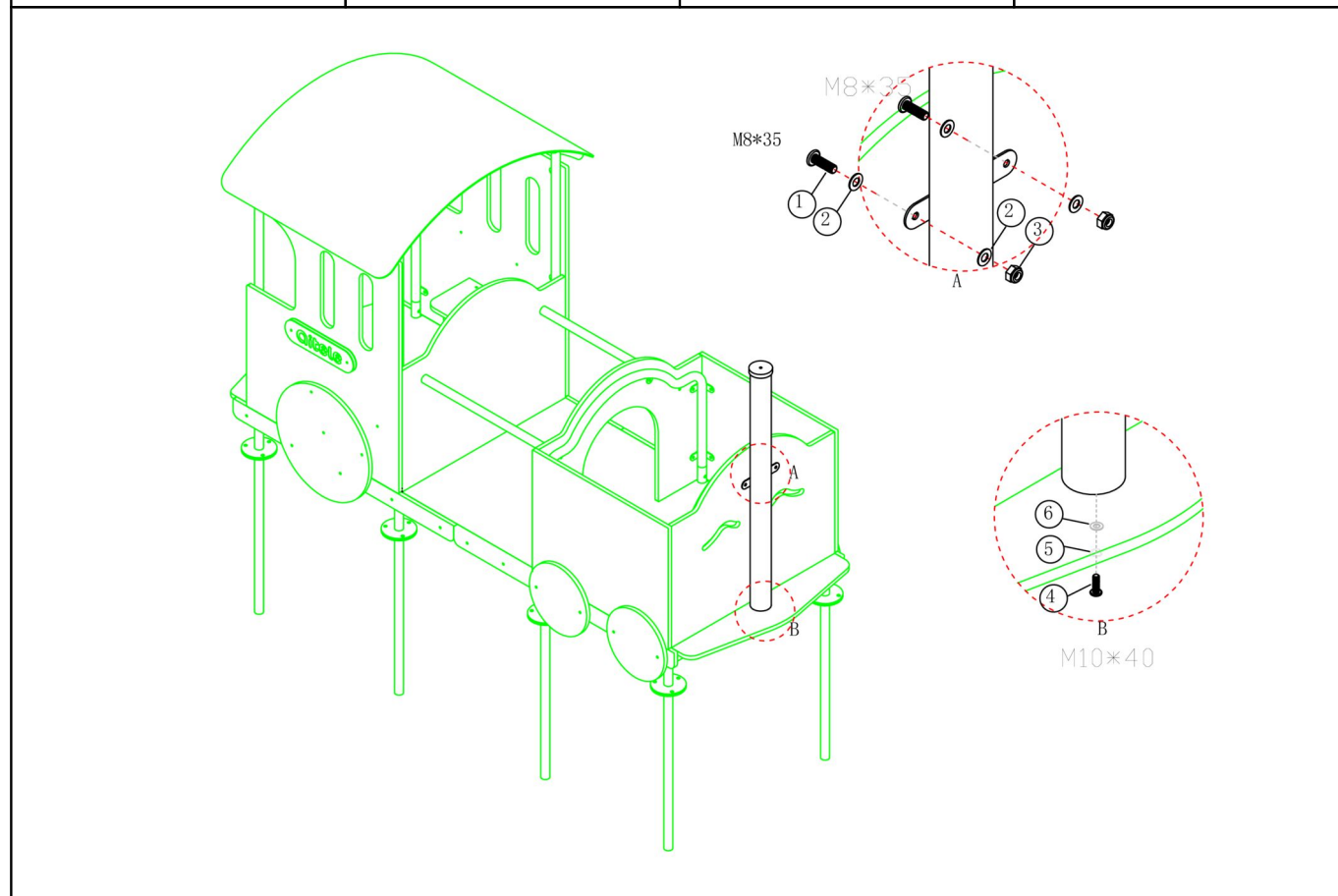

Bevestigings materiaal is per zakje verpakt en bovenstaande afbeelding zit in het zakje