



# TnT speeltoestellen

## Montagehandleiding PH-2001



---

Toestel typenummer	<b>PH-2001</b>
Datum montagehandleiding	<b>28/03/2022</b>
Versienummer montagehandleiding	<b>2.0</b>

---

Beste klant van TnT Speeltoestellen,

Wij danken u voor het aanschaffen en installeren van een speeltoestel van TnT Speeltoestellen. Wij waarderen het vertrouwen dat u in ons bedrijf heeft geplaatst en streven ernaar om uw vertrouwen meer dan waar te maken!

Dit is uw TnT speeltoestellen montagehandleiding.

Wij hebben deze handleiding specifiek voor het product ontworpen, waarop eveneens de toe te passen onderdelen zijn genoemd.

Ook vindt u het grondplan met de benodigde valruimte volgens norm NEN-EN1176-1 : 2017.

Bewaart u dit document bij uw logboek. Nogmaals willen wij u bedanken voor de aankoop van dit speeltoestel. Wij zien uit naar uw volgende speelproject.

Met vriendelijke groet, TnT Speeltoestellen



## Inhoudsopgave

Aanzichten 3D .....	3
Onderdelenlijst .....	4
Veiligheidsruimtes .....	5
Aanzichten 2D .....	6
Plattegrond palenplan .....	7
Onderdeel handleidingen .....	8
<i>Staander PH-2001</i> .....	9
<i>Vloer PH-2001</i> .....	11
<i>Hek-1 PH-2001</i> .....	13
<i>Hek-2 PH-2001</i> .....	15
<i>Hek-3 PH-2001</i> .....	17
<i>Netopgang PH-2001</i> .....	19
<i>Spinner PH-2001</i> .....	21
<i>Glijpalen PH-2001</i> .....	23
<i>Ladder PH-2001</i> .....	25

## Aanzichten 3D



Aanzicht 1



Aanzicht 2

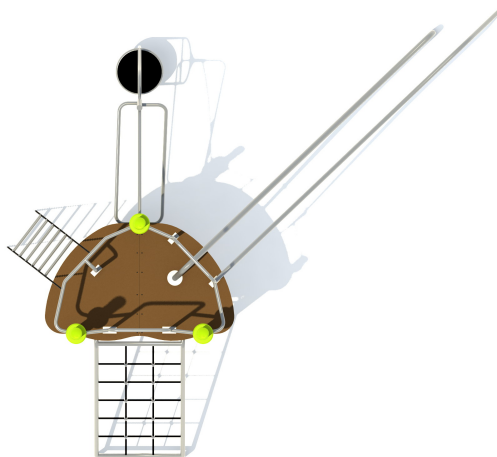

Aanzicht 3

## Onderdelenlijst

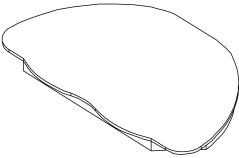
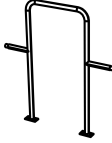
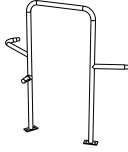
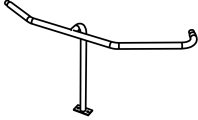
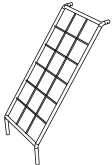
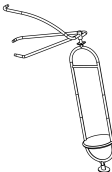
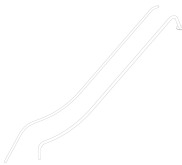
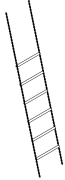
<p><b>3 st. Staander PH-2001</b></p>	<p><b>1 st. Vloer PH-2001</b></p>	<p><b>1 st. Hek-1 PH-2001</b></p>	<p><b>1 st. Hek-2 PH-2001</b></p>
<p>410xØ11,4cm</p>	<p>197x120x10cm</p>	<p>125x117x4cm</p>	<p>128x52x125cm</p>
			
<p><b>1 st. Hek-3 PH-2001</b></p>	<p><b>1 st. Netopgang PH-2001</b></p>	<p><b>1 st. Spinner PH-2001</b></p>	<p><b>1 st. Glijpalen PH-2001</b></p>
<p>128x75cm</p>	<p>254x130x95cm</p>	<p>188x303x54cm</p>	<p>535x344cm</p>
			
<p><b>1 st. Ladder PH-2001</b></p>			
<p>340x53cm</p>			
			

## Veiligheidsruimtes

Geachte klant,

Zorg er altijd voor dat alle veiligheids ruimtes zoals aangegeven in ieder geval gehaald worden, dit zijn de minimale vereiste ruimtes voor een veilig gebruik van het speeltoestel.

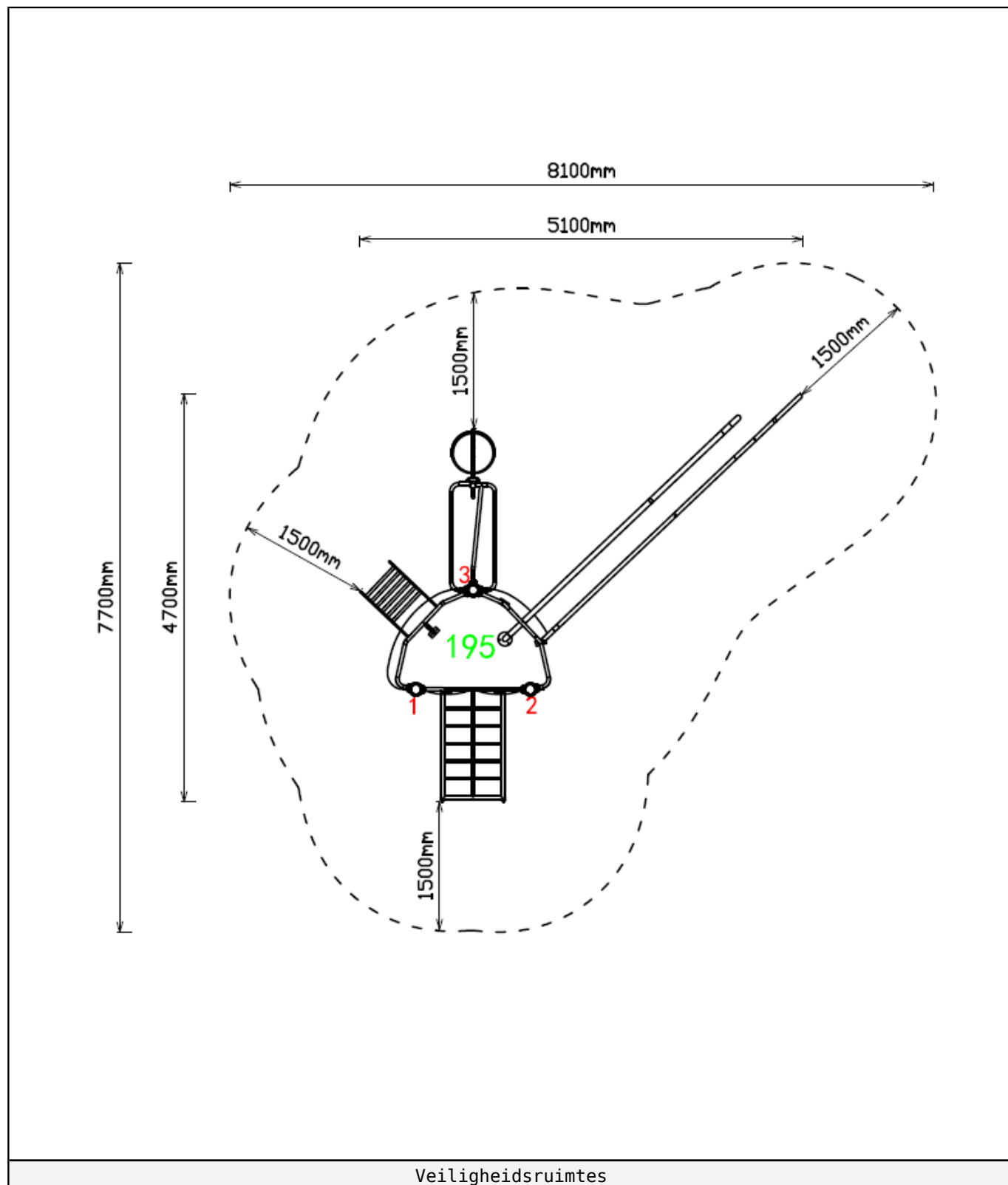

## Aanzichten 2D

Hier vindt u de beschikbare aanzichtstekeningen.

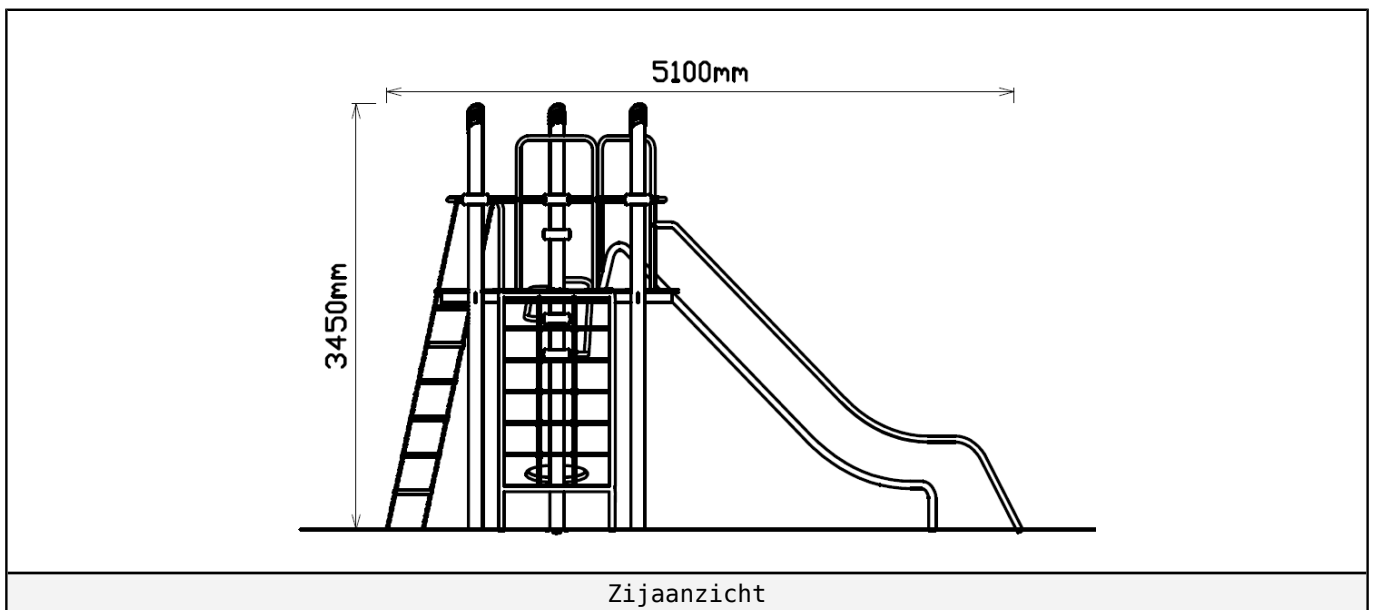
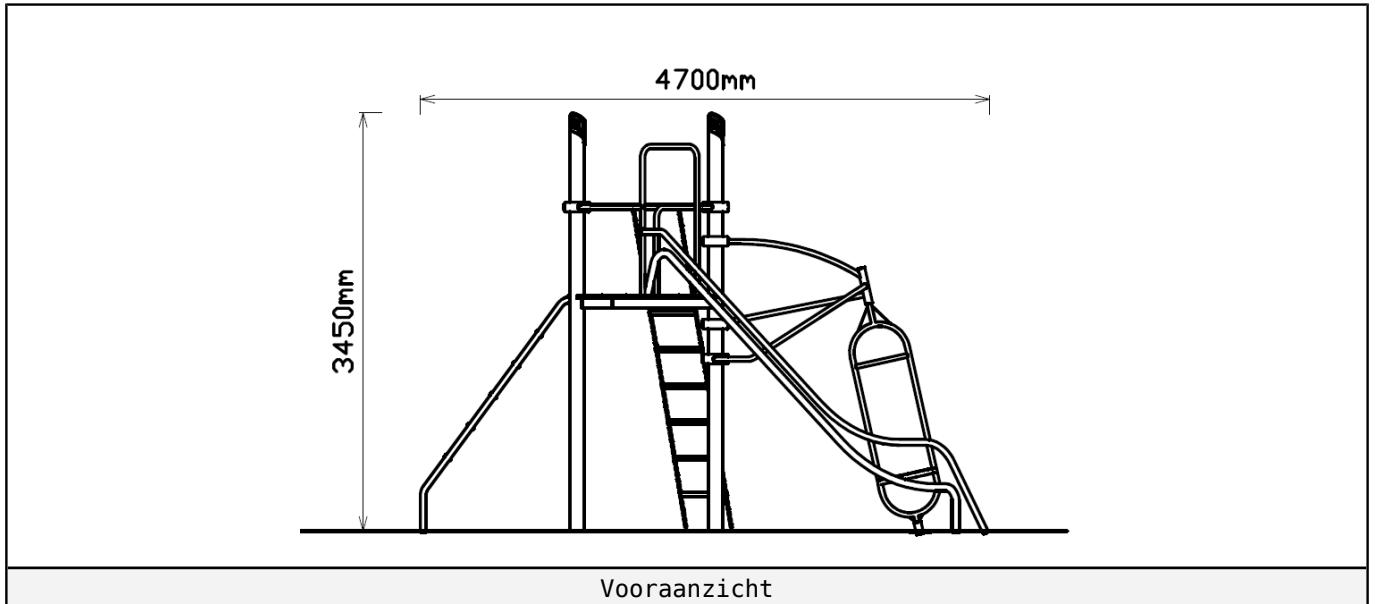



# Plattegrond palenplan

U kunt van deze tekening niet afmeten!

Voor de betonfundatie heeft u 50 kg snelbeton per staander nodig, voor de overige onderdelen (Onderdeel 1, Onderdeel 2) 25 kg snelbeton.

Houdt u er rekening mee dat de betonfundatie minimaal 400mm onder het maaiveld blijft, zoals op de tekening afgebeeld.

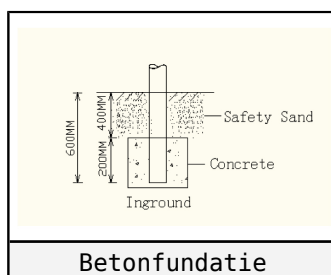
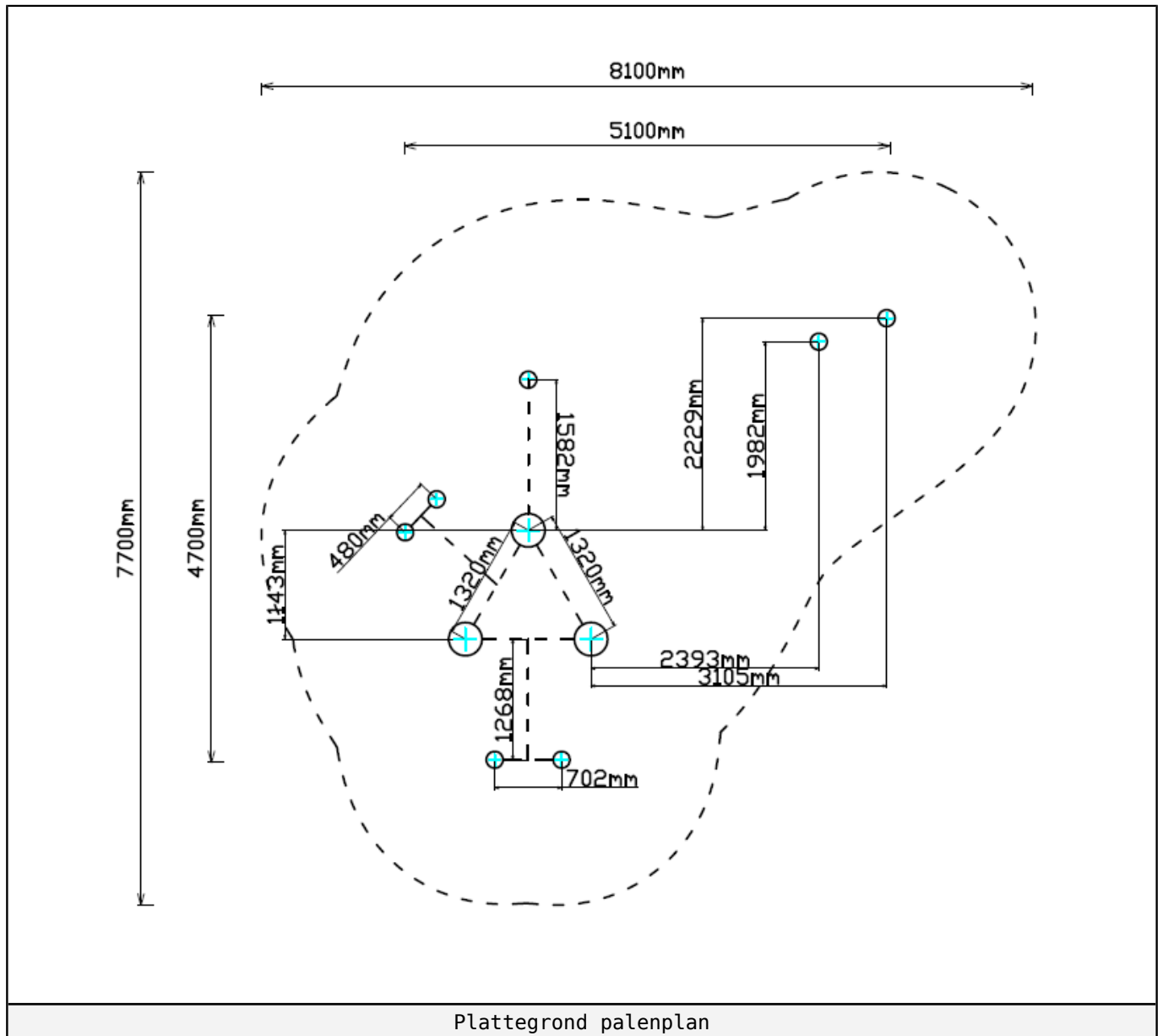

## Onderdeel handleidingen

Op de volgende pagina's van dit document vindt u alle individuele onderdelen met bijhorende technische tekeningen en eventuele montage instructies.





### Staander PH-2001

3 STUKS

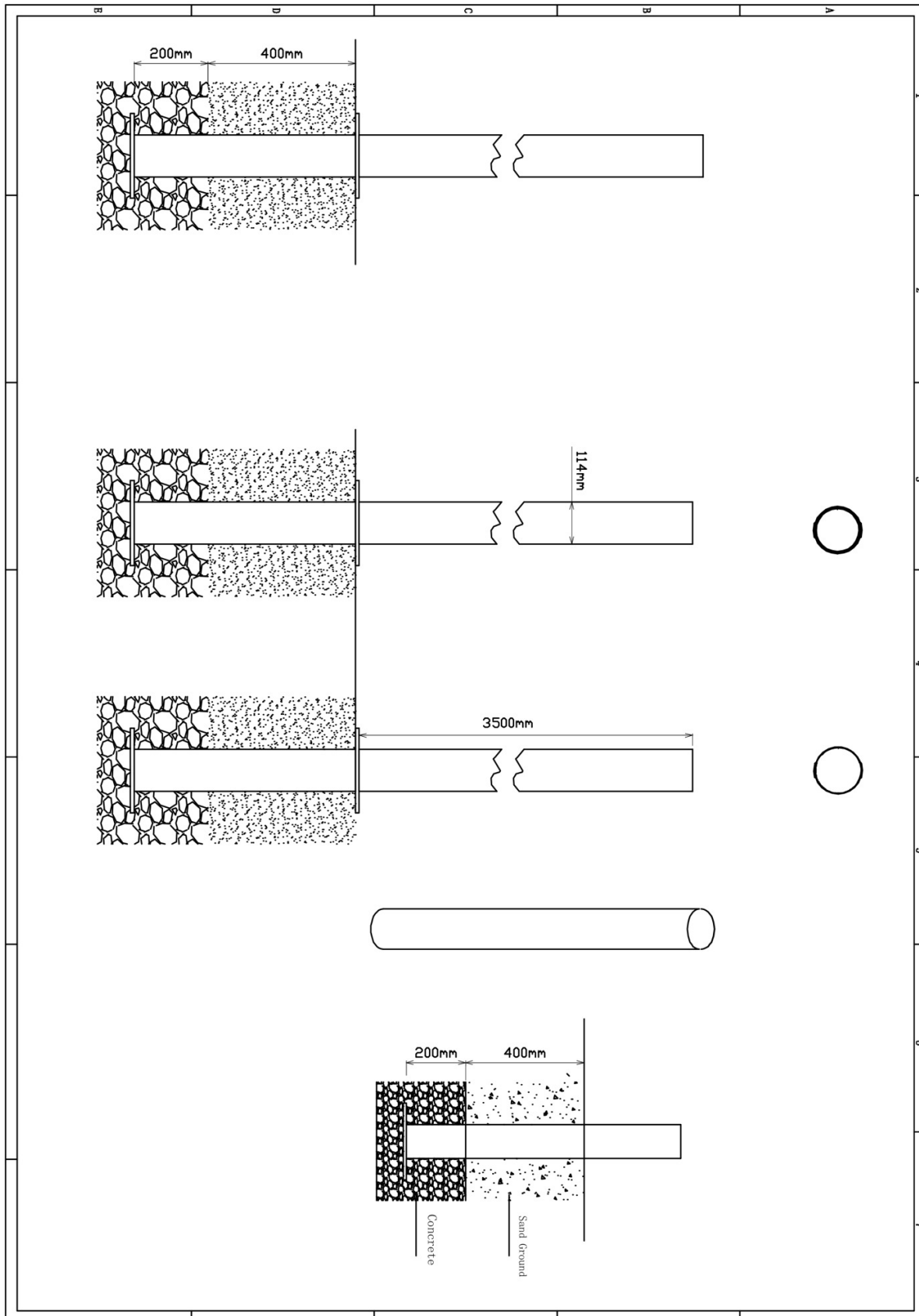

Hoofdafmetingen: 410xØ11,4cm



## Staander PH-2001

STAP 1 van 1

**Omschrijving:** Bevestiging van de paalkap op de staander

1 st. Kunststof paalkap	2 st. Kruiskop M3X16 Zelftap
	

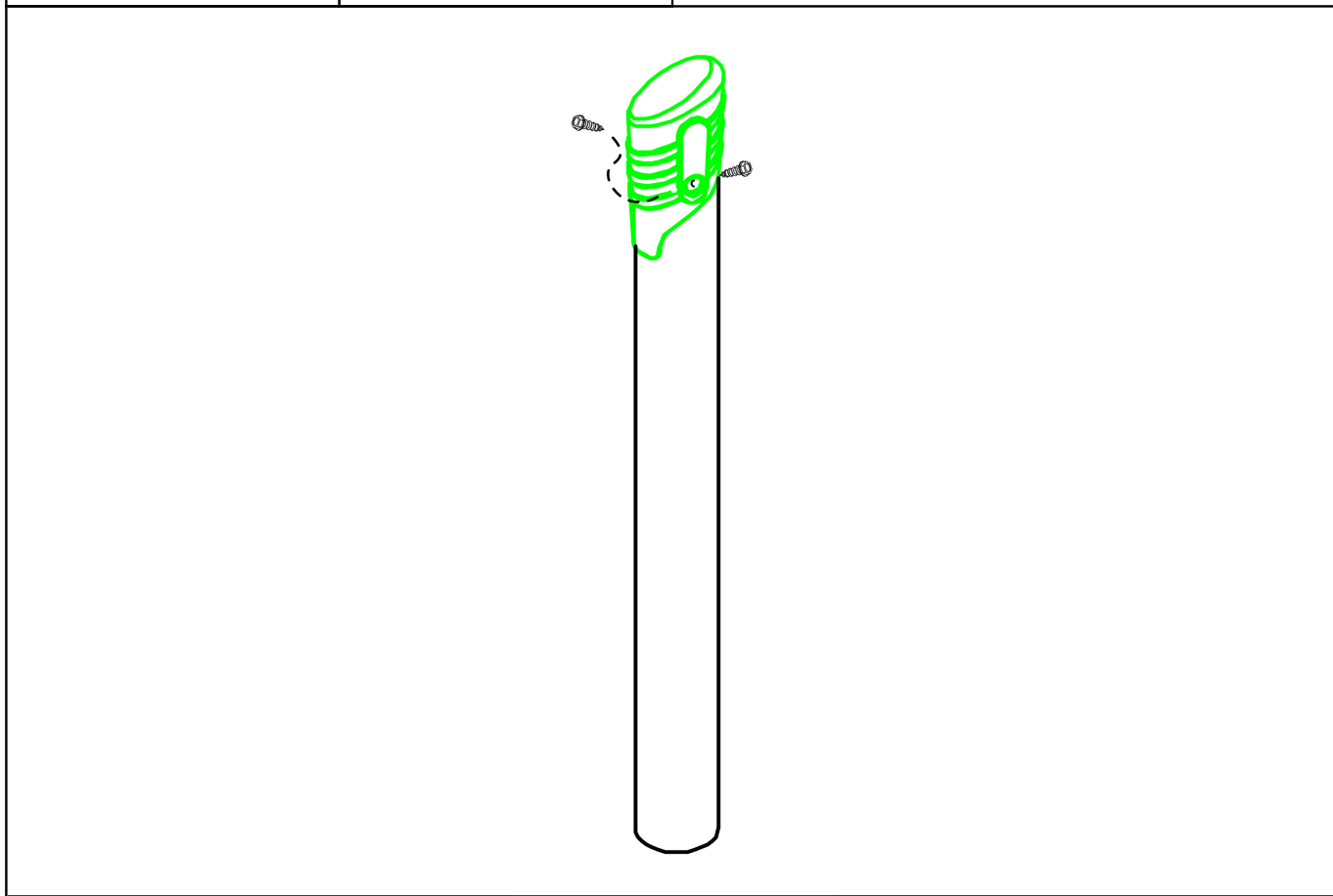

Bevestigings materiaal is per zakje verpakt en bovenstaande afbeelding zit in het zakje



# Vloer PH-2001

1 STUK

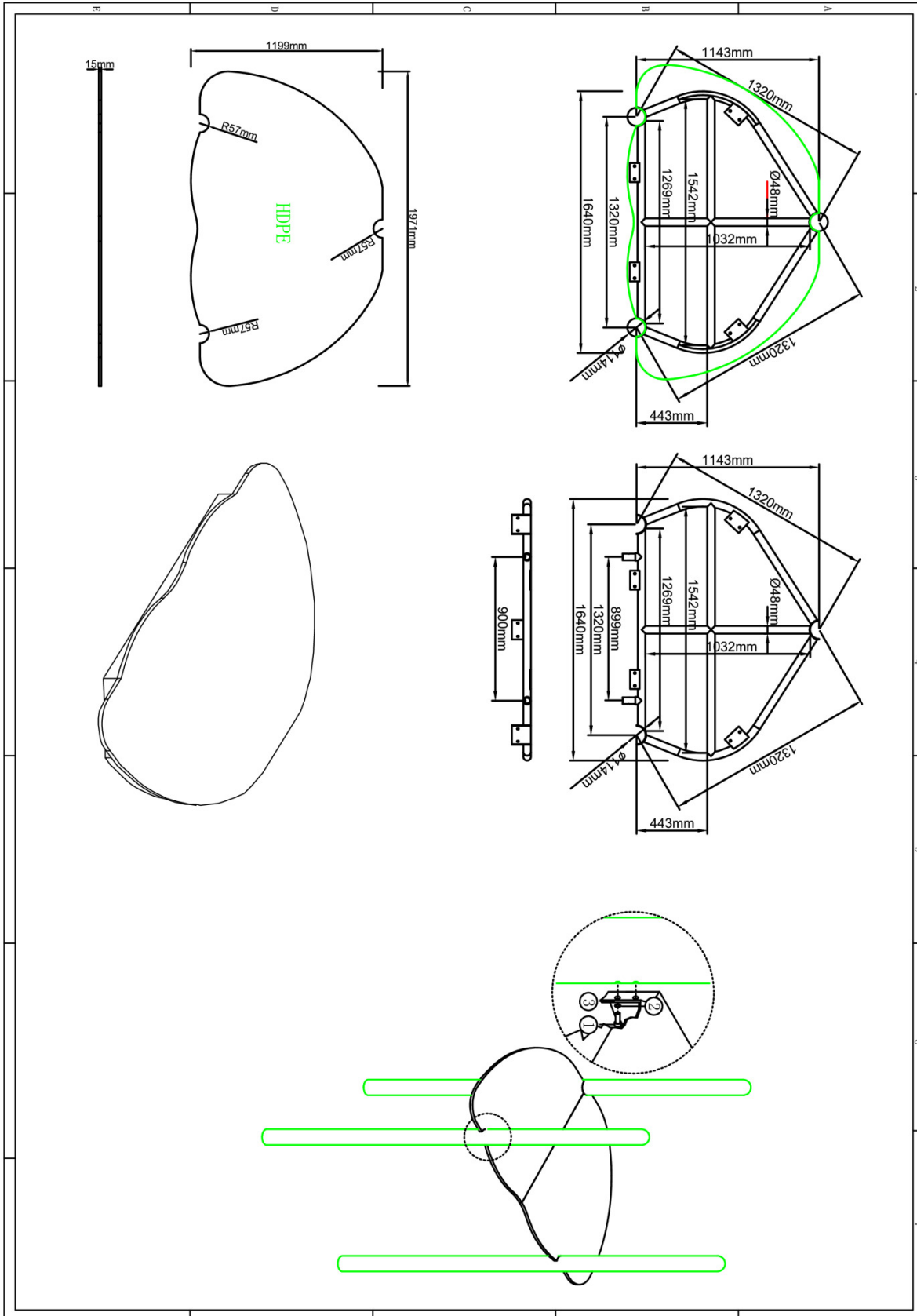

Hoofdafmetingen: 197x120x10cm



**Vloer PH-2001**

STAP 1 van 1

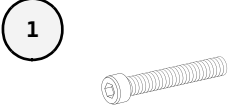
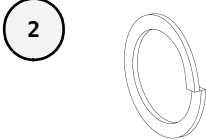
**Omschrijving:** Bevestiging tussen de vloer en de standers

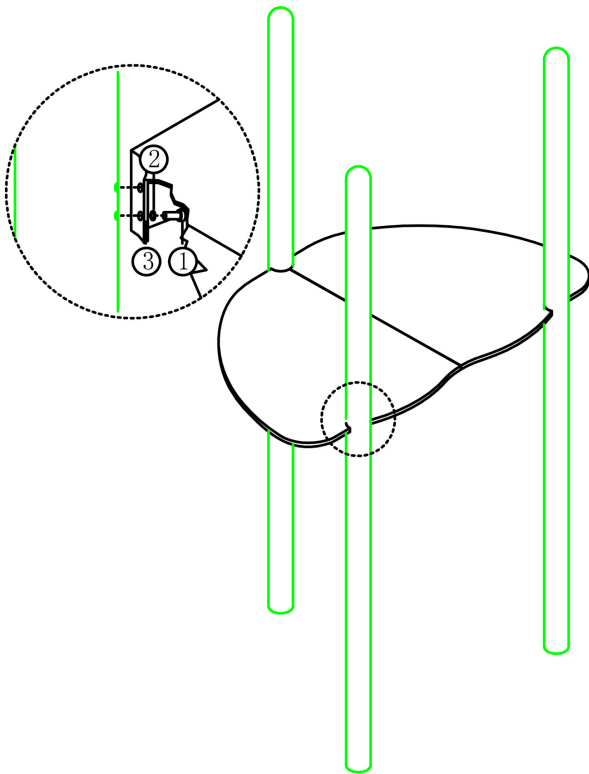
1 st. Vloer PH-2001	3 st. Bout M10X30	3 st. Veerring M10	3 st. Ring M10 (middel)
			
			
Bevestigings materiaal is per zakje verpakt en bovenstaande afbeelding zit in het zakje			



### Hek-1 PH-2001

1 STUK



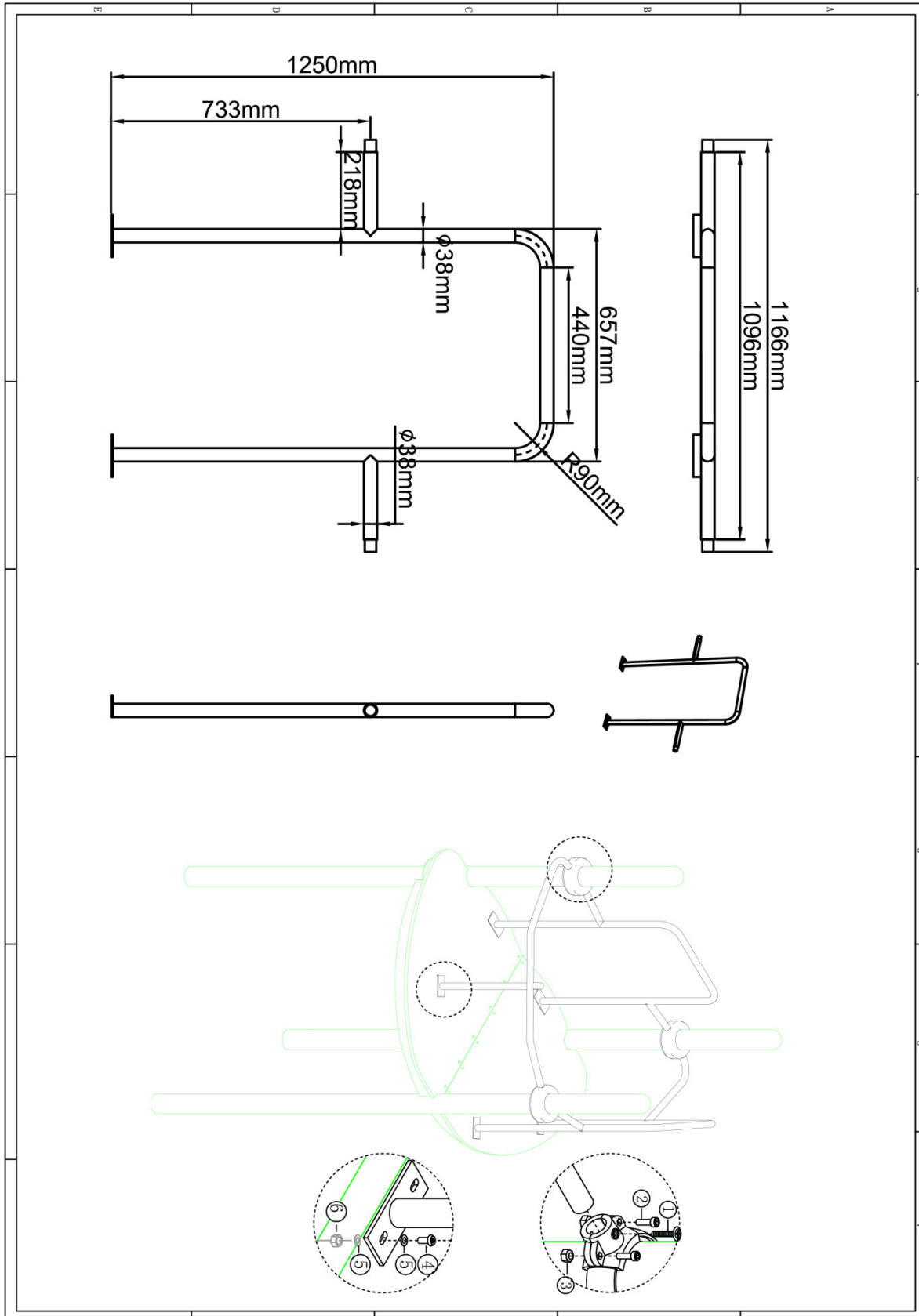







Hoofdafmetingen: 125x117x4cm

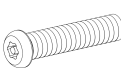
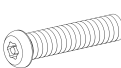
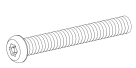

**Hek-1 PH-2001**

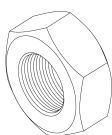
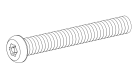
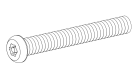
STAP 1 van 1

**Omschrijving:** Bevestiging tussen het hek en de vloer / staander

1 st. Hek-1 PH-2001	2 st. Small clamp + ring	4 st. Afdekdop M10	2 st. Kruiskop M6X65
			 
4 st. Torx M8X20	4 st. Lock Moer M8	2 st. Lock Moer M6	4 st. Torx M10X35
 	 	 	 
8 st. Ring M10 (middel)	4 st. Lock Moer M10		
 	 		

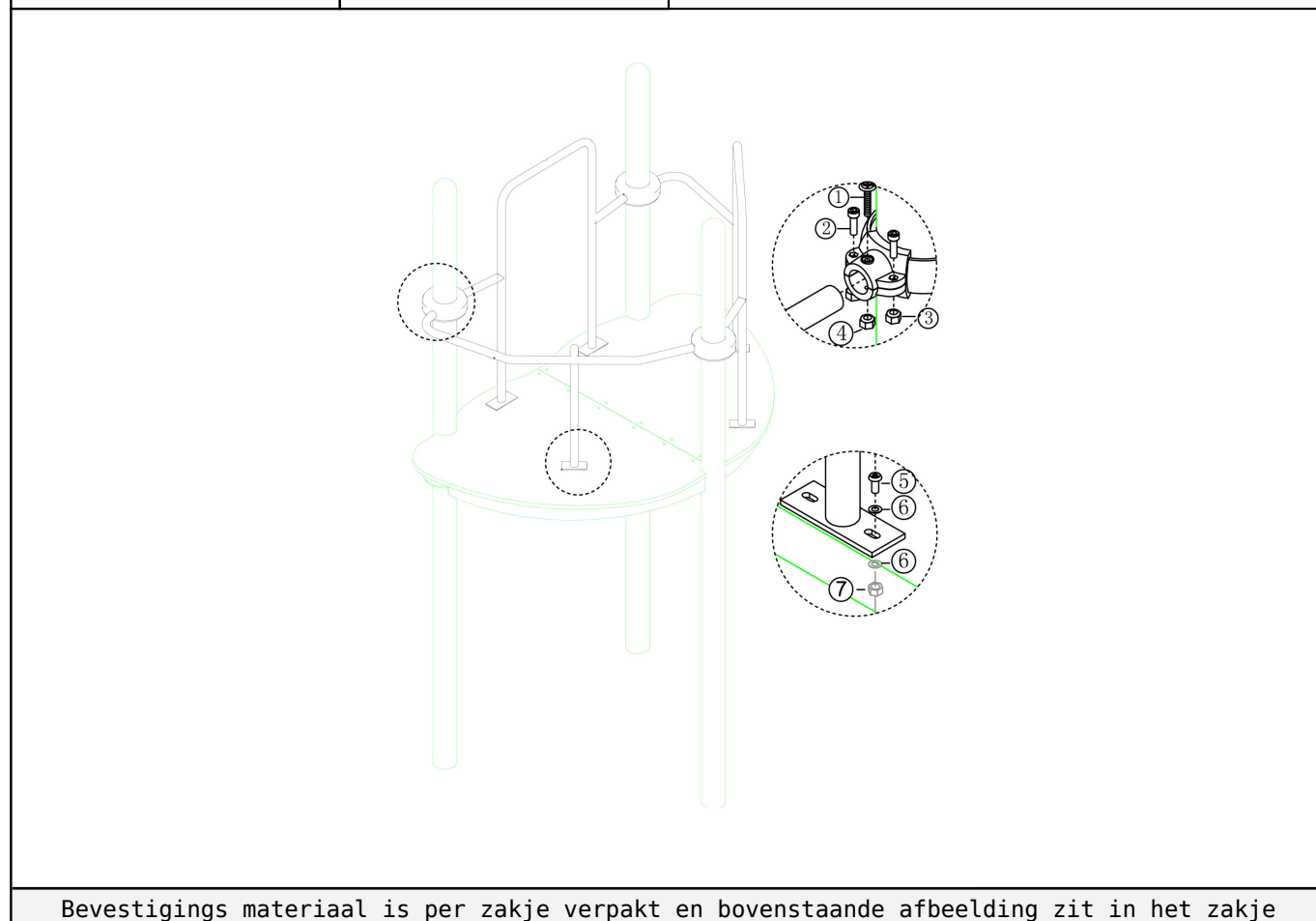

Bevestigings materiaal is per zakje verpakt en bovenstaande afbeelding zit in het zakje



### Hek-2 PH-2001

1 STUK



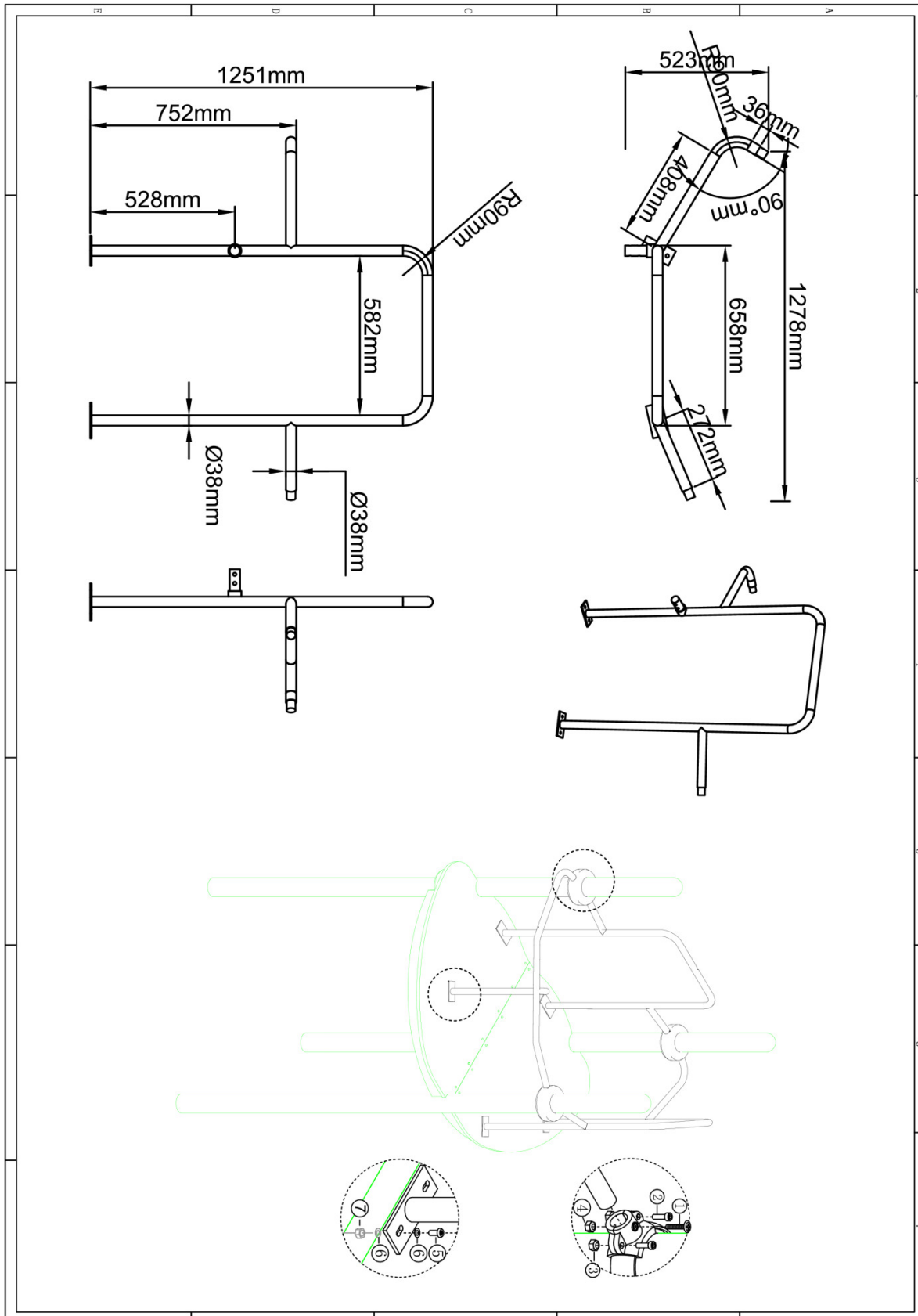

Hoofdafmetingen: 128x52x125cm



**Hek-2 PH-2001**

STAP 1 van 1

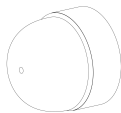
**Omschrijving:** Bevestiging tussen het hek en de vloer / staander

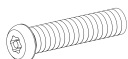
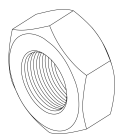
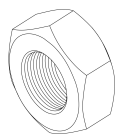
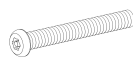
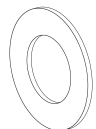
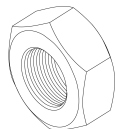
1 st. Hek-2 PH-2001	2 st. Small clamp + ring	4 st. Afdekdop M10	2 st. Kruiskop M6X65
			1 
4 st. Torx M8X20	4 st. Lock Moer M8	2 st. Lock Moer M6	4 st. Torx M10X35
2 	3 	4 	5 
8 st. Ring M10 (middel)	4 st. Lock Moer M10		
6 	7 		

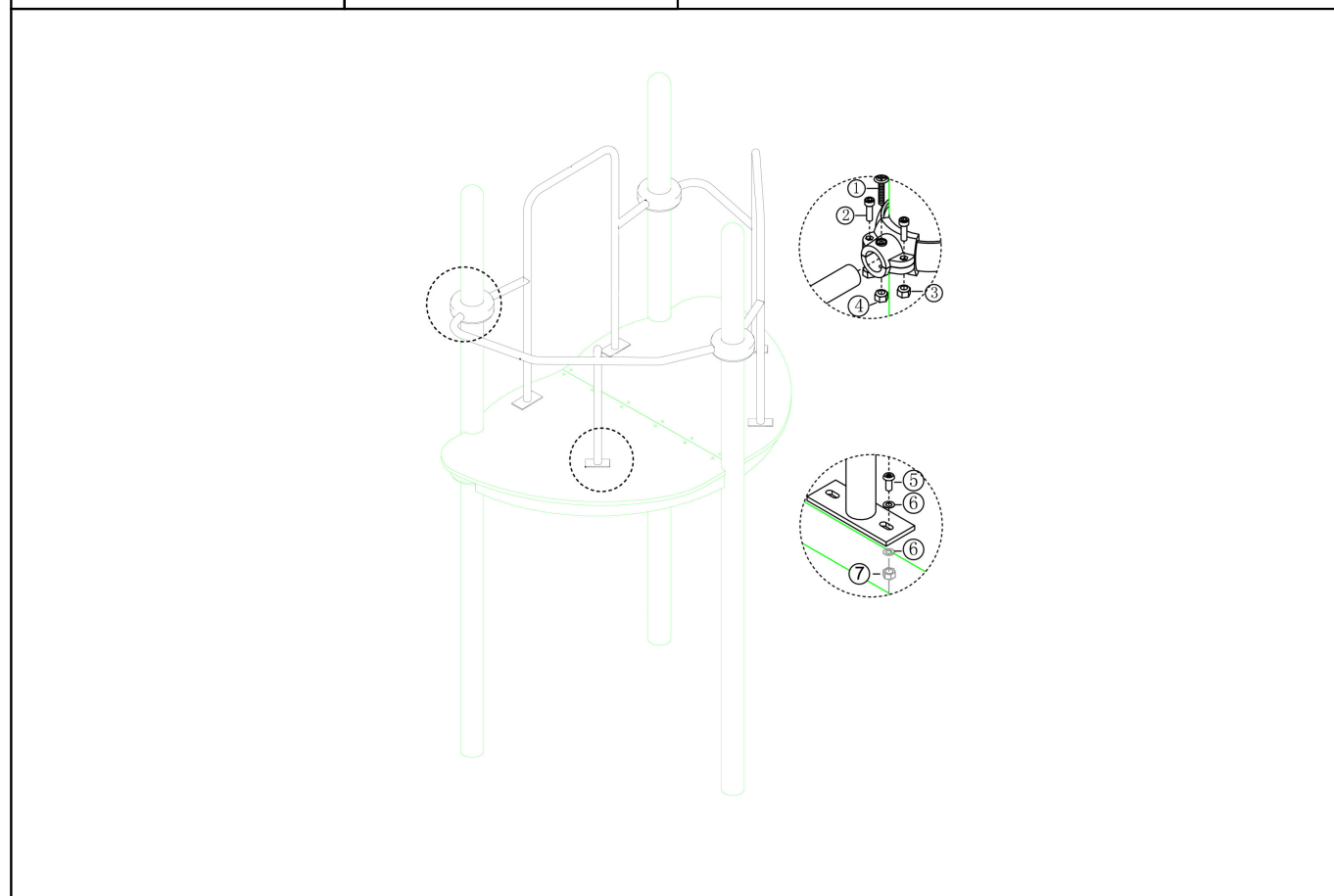

Bevestigings materiaal is per zakje verpakt en bovenstaande afbeelding zit in het zakje





### Hek-3 PH-2001

1 STUK



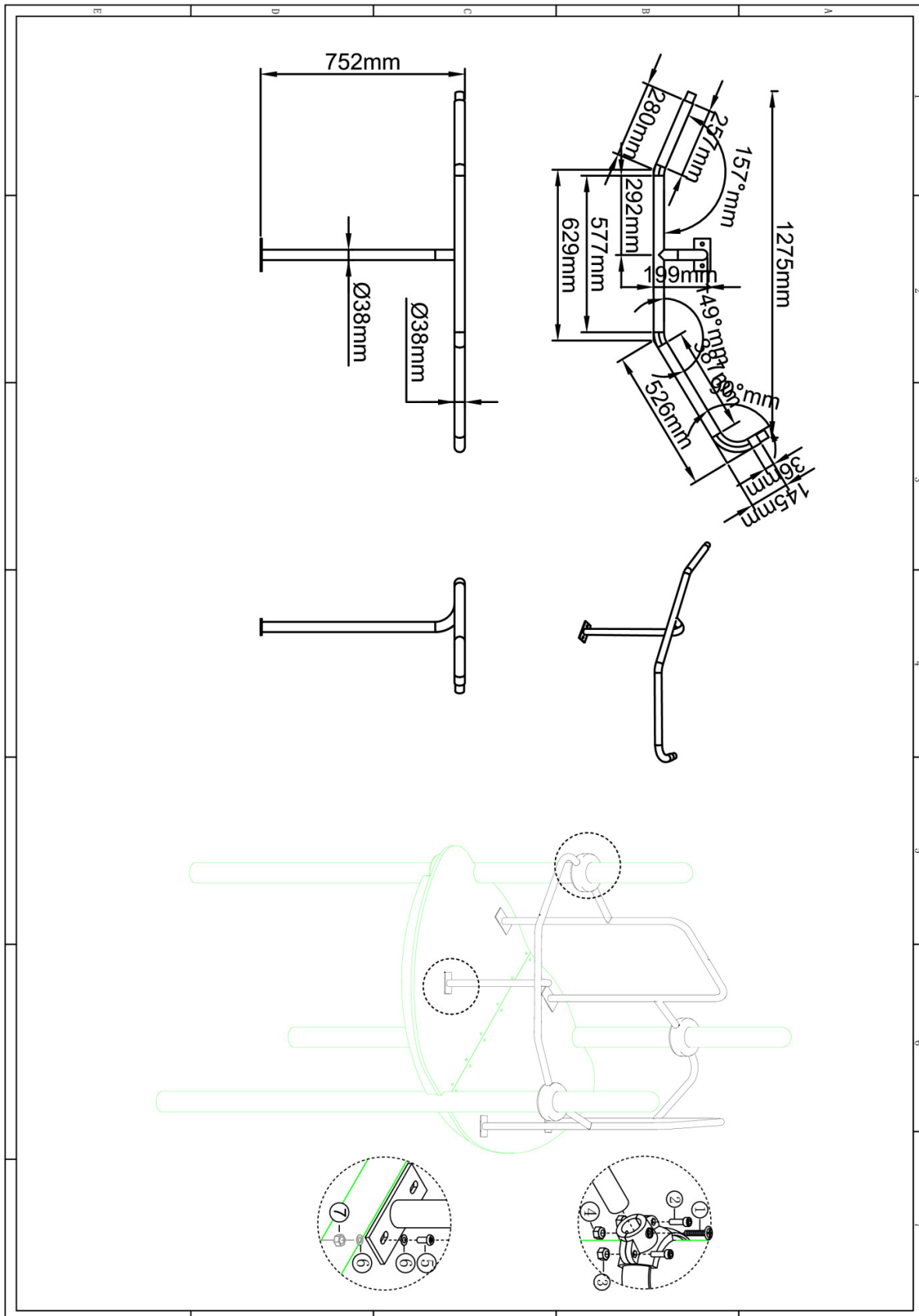



Hoofdafmetingen: 128x75cm

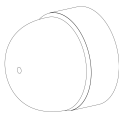

**Hek-3 PH-2001**

STAP 1 van 1

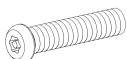
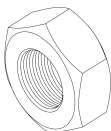
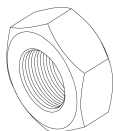
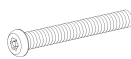
**Omschrijving:** Bevestiging tussen het hek en de vloer / staander

1 st. Hek-3 PH-2001	2 st. Small clamp + ring	2 st. Afdekdop M10	2 st. Kruiskop M6X65
			① 
4 st. Torx M8X20	4 st. Lock Moer M8	2 st. Lock Moer M6	2 st. Torx M10X35
② 	③ 	④ 	⑤ 
4 st. Ring M10 (middel)	2 st. Lock Moer M10		
⑥ 	⑦ 		

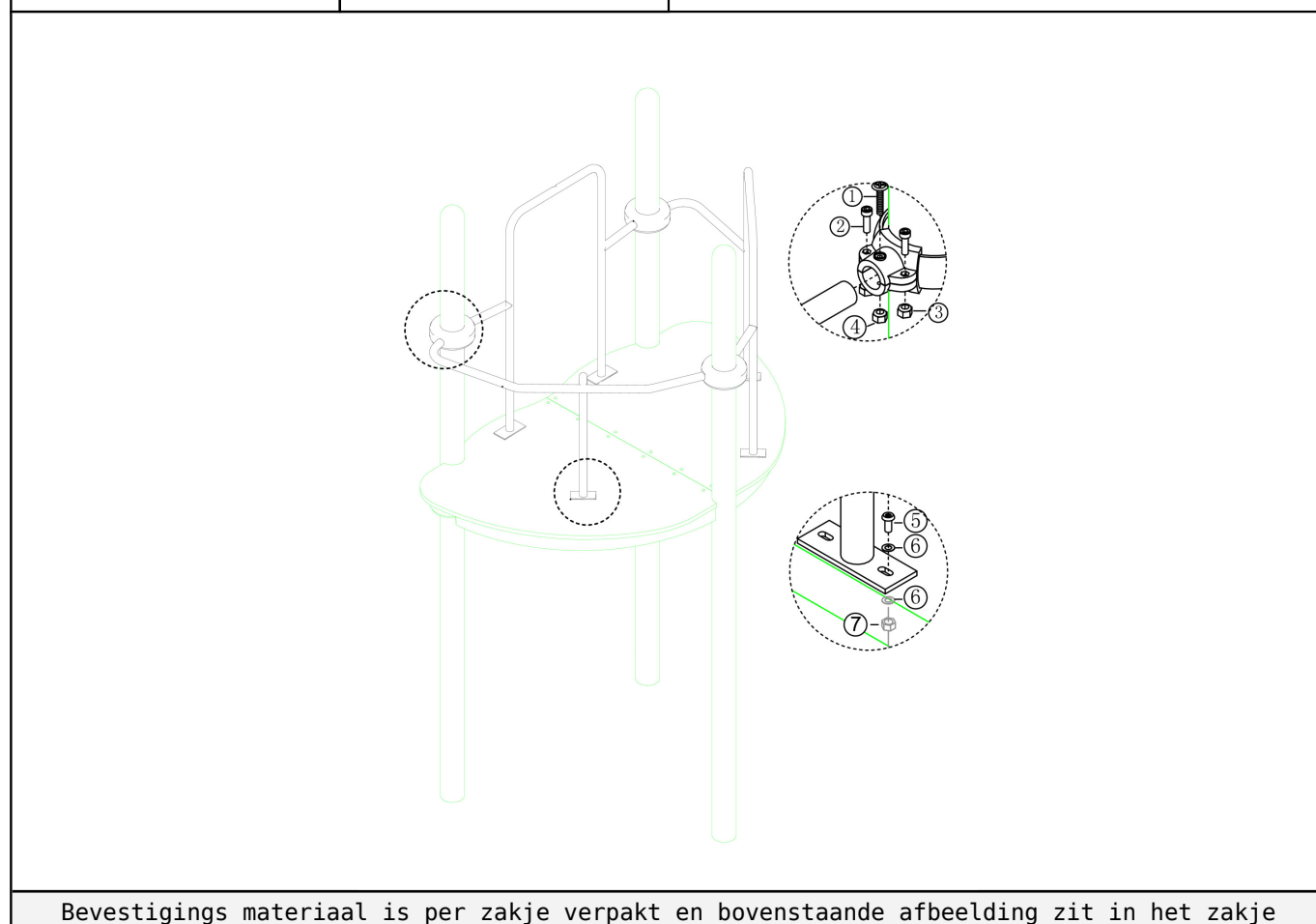

Bevestigings materiaal is per zakje verpakt en bovenstaande afbeelding zit in het zakje

## Netopgang PH-2001

1 STUK

Hoofdafmetingen: 254x130x95cm

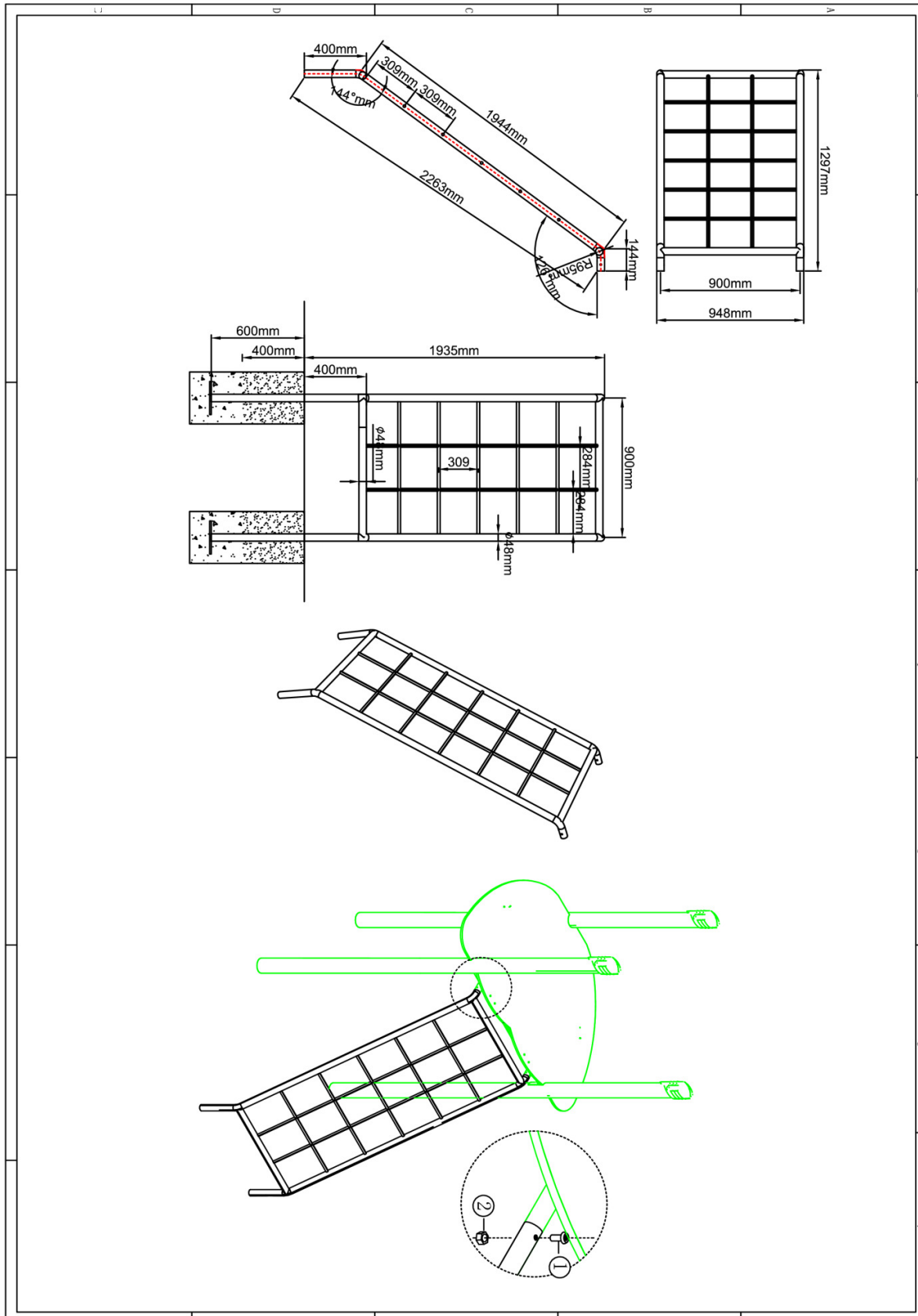

## Netopgang PH-2001

STAP 1 van 1

**Omschrijving:** Bevestiging tussen de netopgang en de vloer

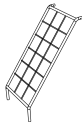
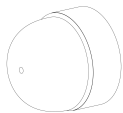
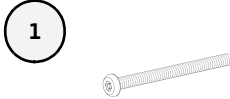
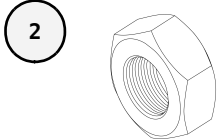
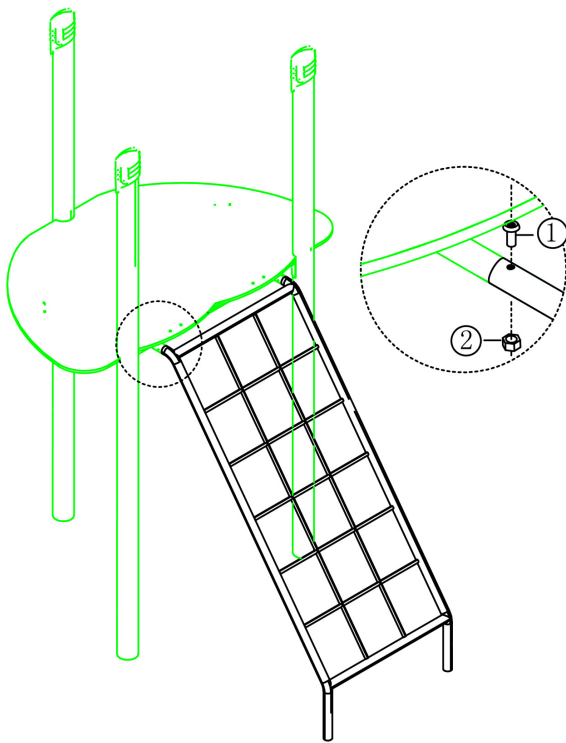
1 st. Netopgang PH-2001	2 st. Afdekdop M10	2 st. Torx M10X55	2 st. Lock Moer M10
			
			
Bevestigings materiaal is per zakje verpakt en bovenstaande afbeelding zit in het zakje			



# Spinner PH-2001

1 STUK

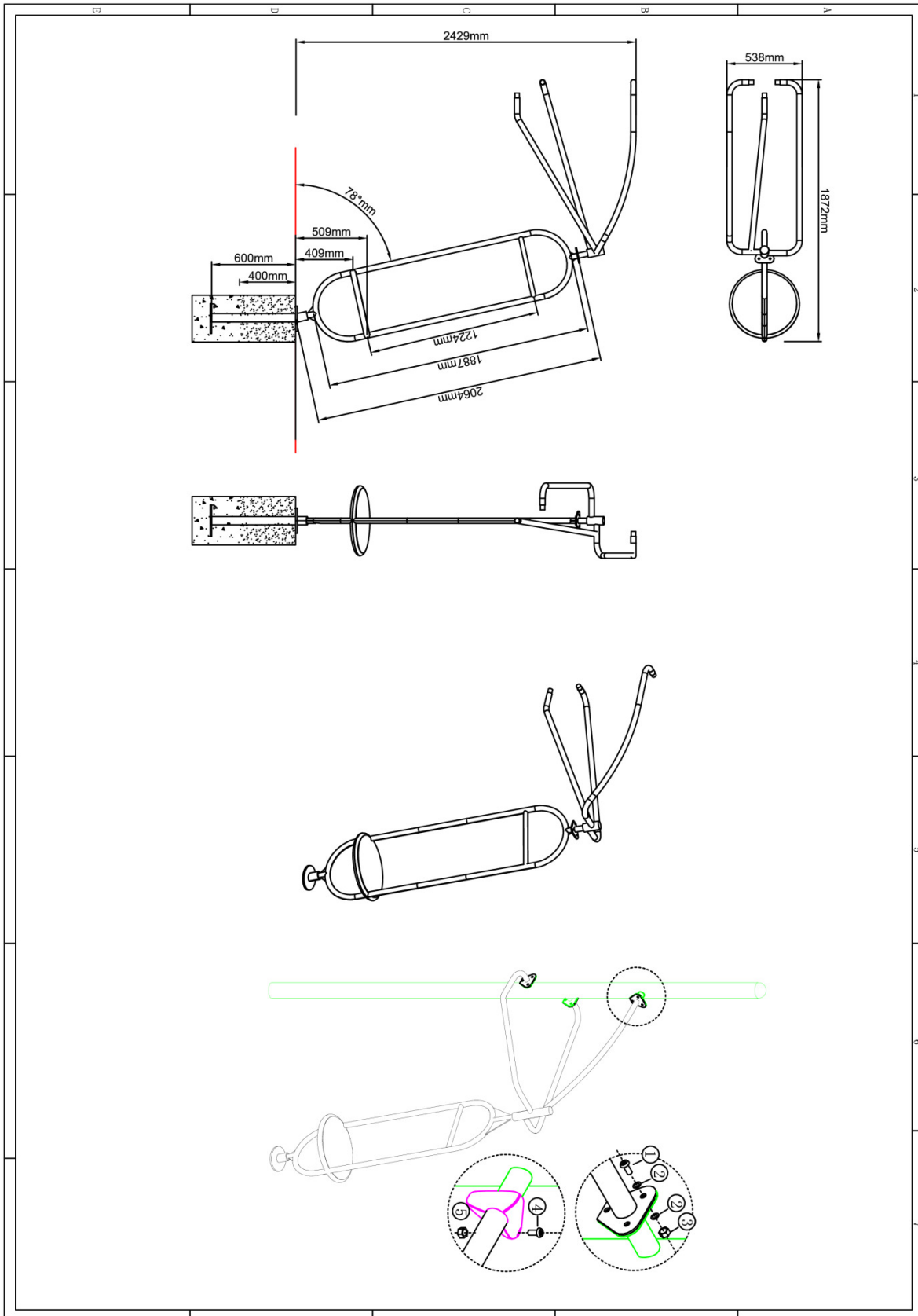

Hoofdafmetingen: 188x303x54cm



## Spinner PH-2001

STAP 1 van 1

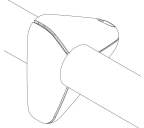
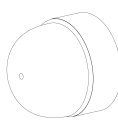
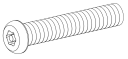
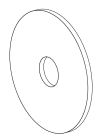
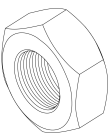
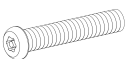
**Omschrijving:** Bevestiging tussen de Spinner en de staander

1 st. Spinner PH-2001	3 st. Kunststof afdekkap	3 st. Afdekdop M8	9 st. Torx M10X25
			① 
18 st. Ring M10 (klein)	9 st. Lock Moer M10	3 st. Torx M8X25	3 st. Lock Moer M8
② 	③ 	④ 	⑤ 

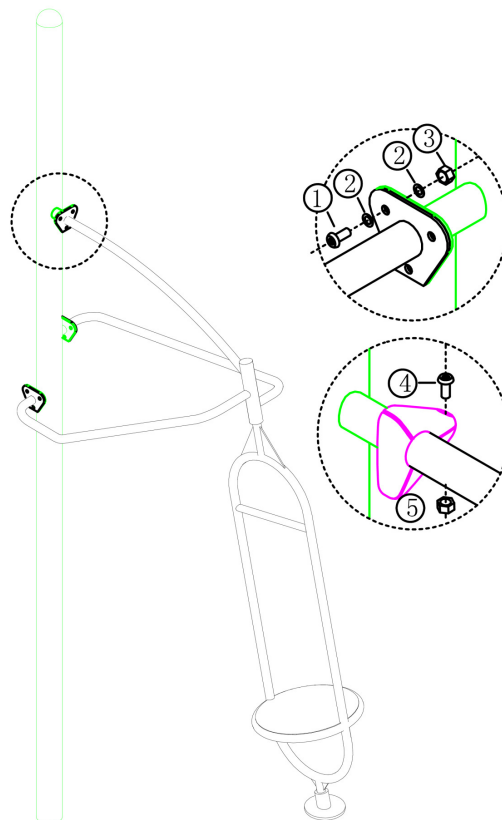

Bevestigings materiaal is per zakje verpakt en bovenstaande afbeelding zit in het zakje

# Glijpalen PH-2001

1 STUK



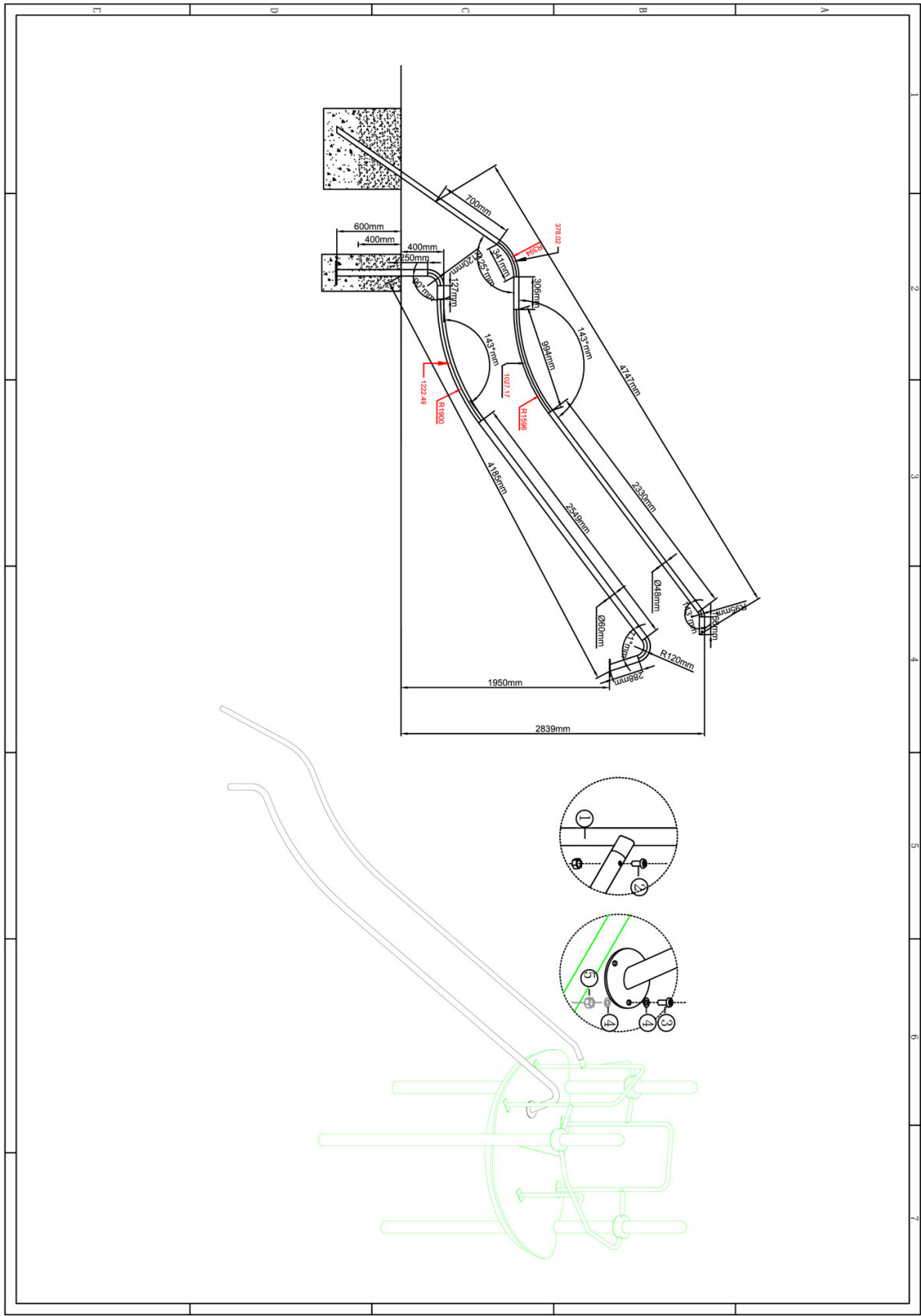

Hoofdafmetingen: 535x344cm

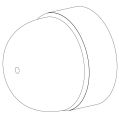

## Glijpalen PH-2001

STAP 1 van 1

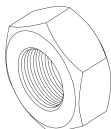
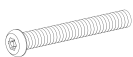
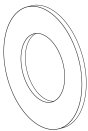
**Omschrijving:** Bevestiging tussen de glijpalen en de vloer / standers

1 st. Glijpalen PH-2001	4 st. Afdekdop M10	1 st. Torx M10X55	1 st. Lock Moer M10
		① 	② 
3 st. Torx M10X35	6 st. Ring M10 (middel)	3 st. Lock Moer M10	
③ 	④ 	⑤ 	

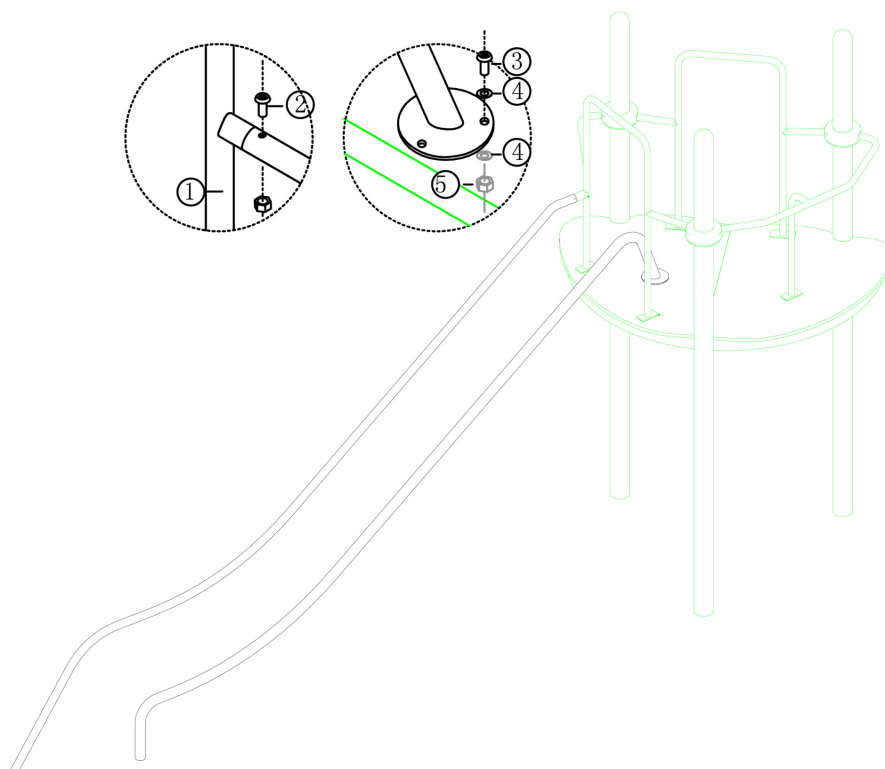

Bevestigings materiaal is per zakje verpakt en bovenstaande afbeelding zit in het zakje





# Ladder PH-2001

1 STUK

Hoofdafmetingen: 340x53cm

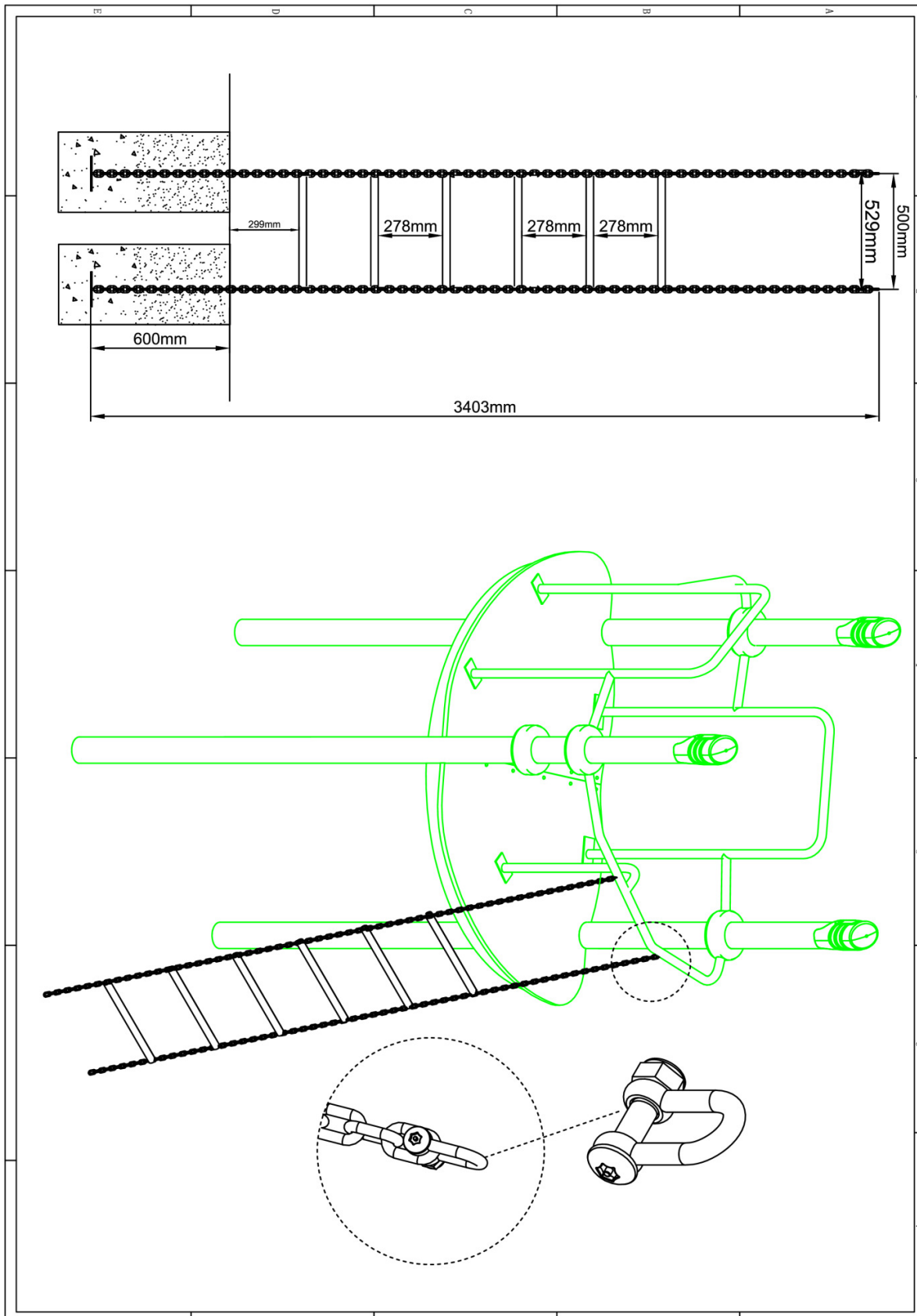

## Ladder PH-2001

STAP 1 van 1

**Omschrijving:** Bevestiging tussen de ladder en het hek

1 st. Ladder PH-2001	2 st. D-haak M8
