

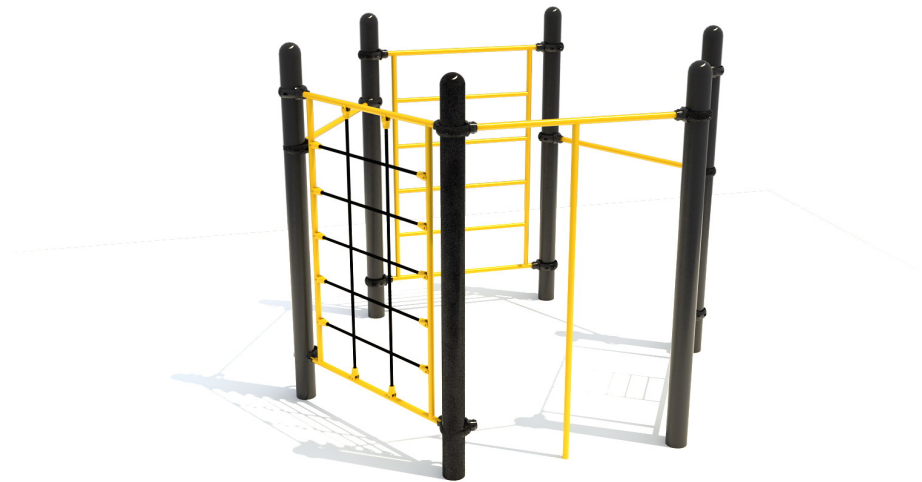

TnT speeltoestellen

Montagehandleiding K-435



Toestel typenummer	K-435
Datum montagehandleiding	11/01/2021
Versienummer montagehandleiding	2.0

Beste klant van TnT Speeltoestellen,

Wij danken u voor het aanschaffen en installeren van een speeltoestel van TnT Speeltoestellen. Wij waarderen het vertrouwen dat u in ons bedrijf heeft geplaatst en streven ernaar om uw vertrouwen meer dan waar te maken!

Dit is uw TnT speeltoestellen montagehandleiding.

Wij hebben deze handleiding specifiek voor het product ontworpen, waarop eveneens de toe te passen onderdelen zijn genoemd.

Ook vindt u het grondplan met de benodigde valruimte volgens norm NEN-EN1176-1 : 2017.

Bewaart u dit document bij uw logboek. Nogmaals willen wij u bedanken voor de aankoop van dit speeltoestel. Wij zien uit naar uw volgende speelproject.

Met vriendelijke groet, TnT Speeltoestellen



Inhoudsopgave

Aanzichten 3D	3
Onderdelenlijst	4
Veiligheidsruimtes	5
Aanzichten 2D	6
Plattegrond palenplan	7
Onderdeel handleidingen	8
<i>Staander K-435</i>	9
<i>Verticale Ladder K-435</i>	13
<i>Stangenopgang K-435</i>	16
<i>Klimnet K-435</i>	19
<i>Glijstang K-435</i>	22
<i>Stang K-435 (hoogte 120cm)</i>	24
<i>Stang K-435 (hoogte 150cm)</i>	28



Aanzichten 3D

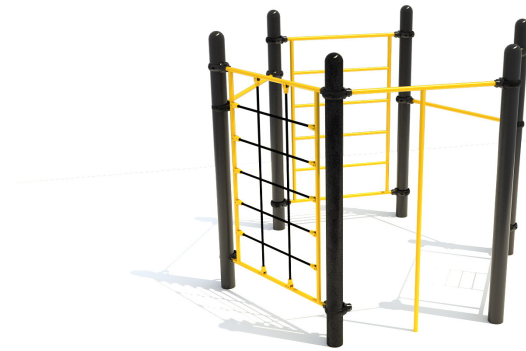

Aanzicht 1



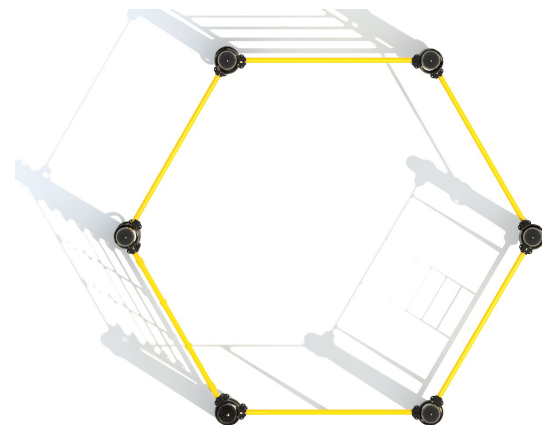

Aanzicht 2

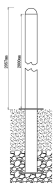
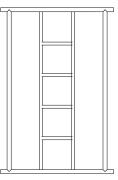

Aanzicht 3

Onderdelenlijst

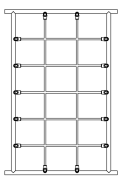
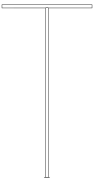
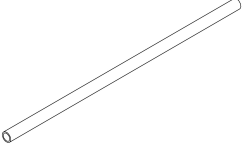
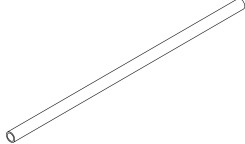
6 st. Staander K-435	1 st. Verticale Ladder K-435	1 st. Stangenopgang K-435	1 st. Klimnet K-435
260xØ11,4cm	154x105x4cm	153x105x4cm	154x105x4cm
			
1 st. Glijstang K-435	1 st. Stang K-435 (hoogte 120cm)	1 st. Stang K-435 (hoogte 150cm)	
242x105x4cm	105xØ3,2cm	105xØ3,2cm	
			

Veiligheidsruimtes

Geachte klant,

Zorg er altijd voor dat alle veiligheids ruimtes zoals aangegeven in ieder geval gehaald worden, dit zijn de minimale vereiste ruimtes voor een veilig gebruik van het speeltoestel.

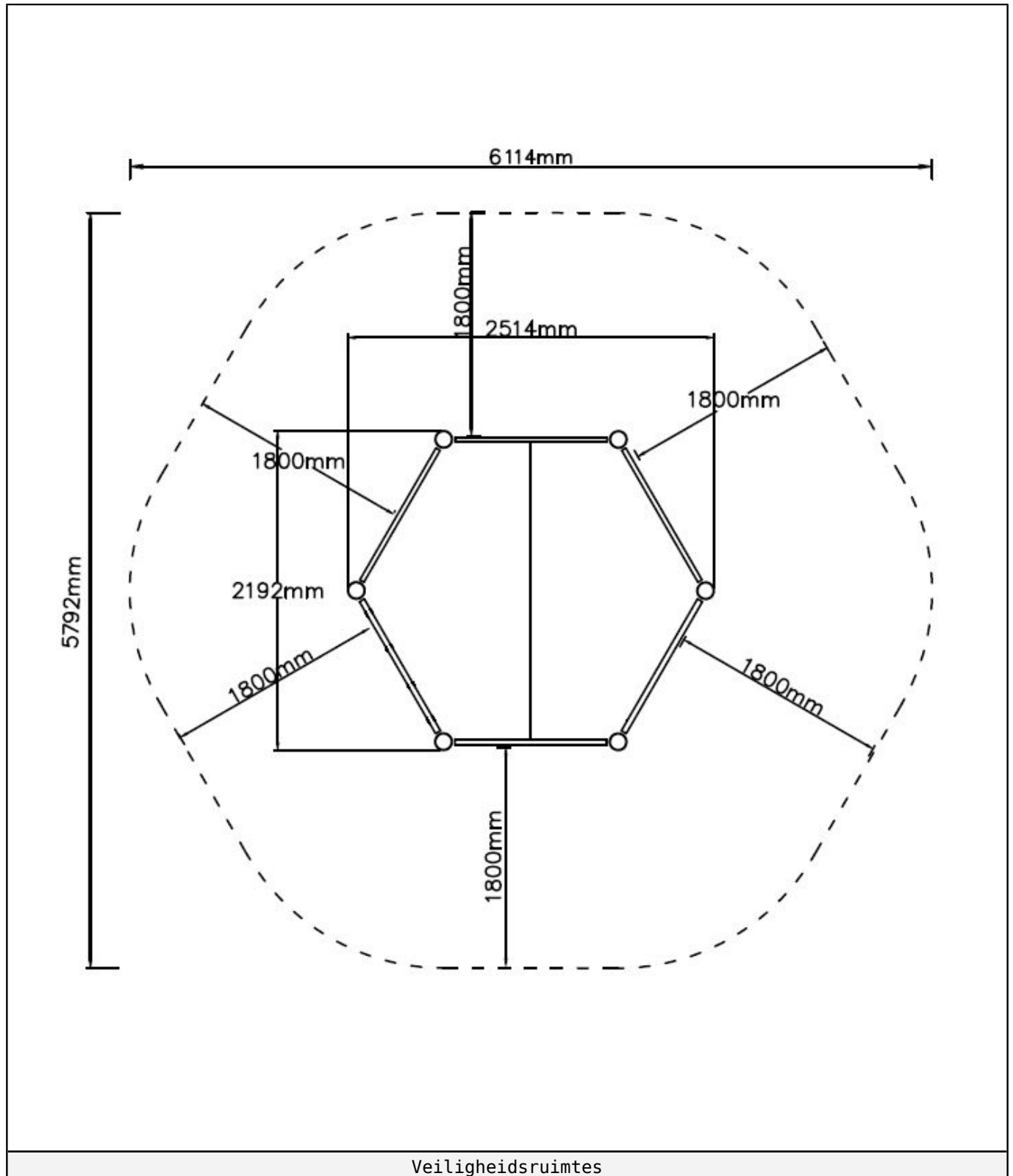

Aanzichten 2D

Hier vindt u de beschikbare aanzichtstekeningen.

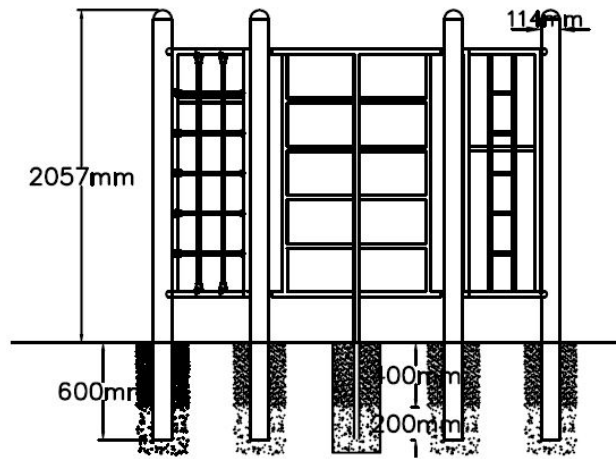

Vooraanzicht

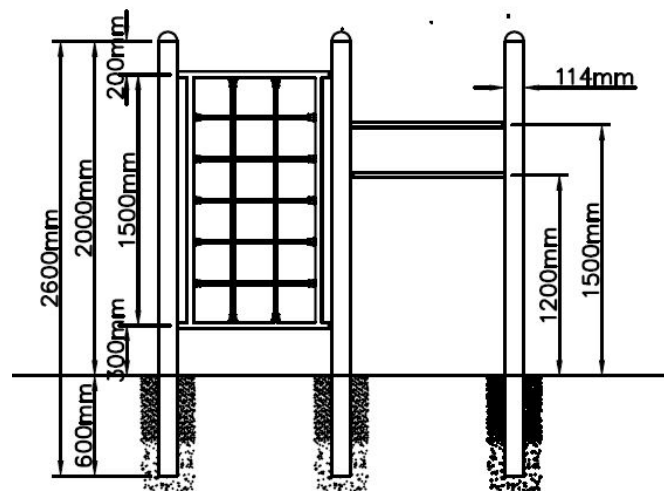

Zijaanzicht



Plattegrond palenplan

U kunt van deze tekening niet afmeten!

Voor de betonfundatie heeft u 50 kg snelbeton per staander nodig.

Houdt u er rekening mee dat de betonfundatie minimaal 400mm onder het maaiveld blijft, zoals op de tekening afgebeeld.

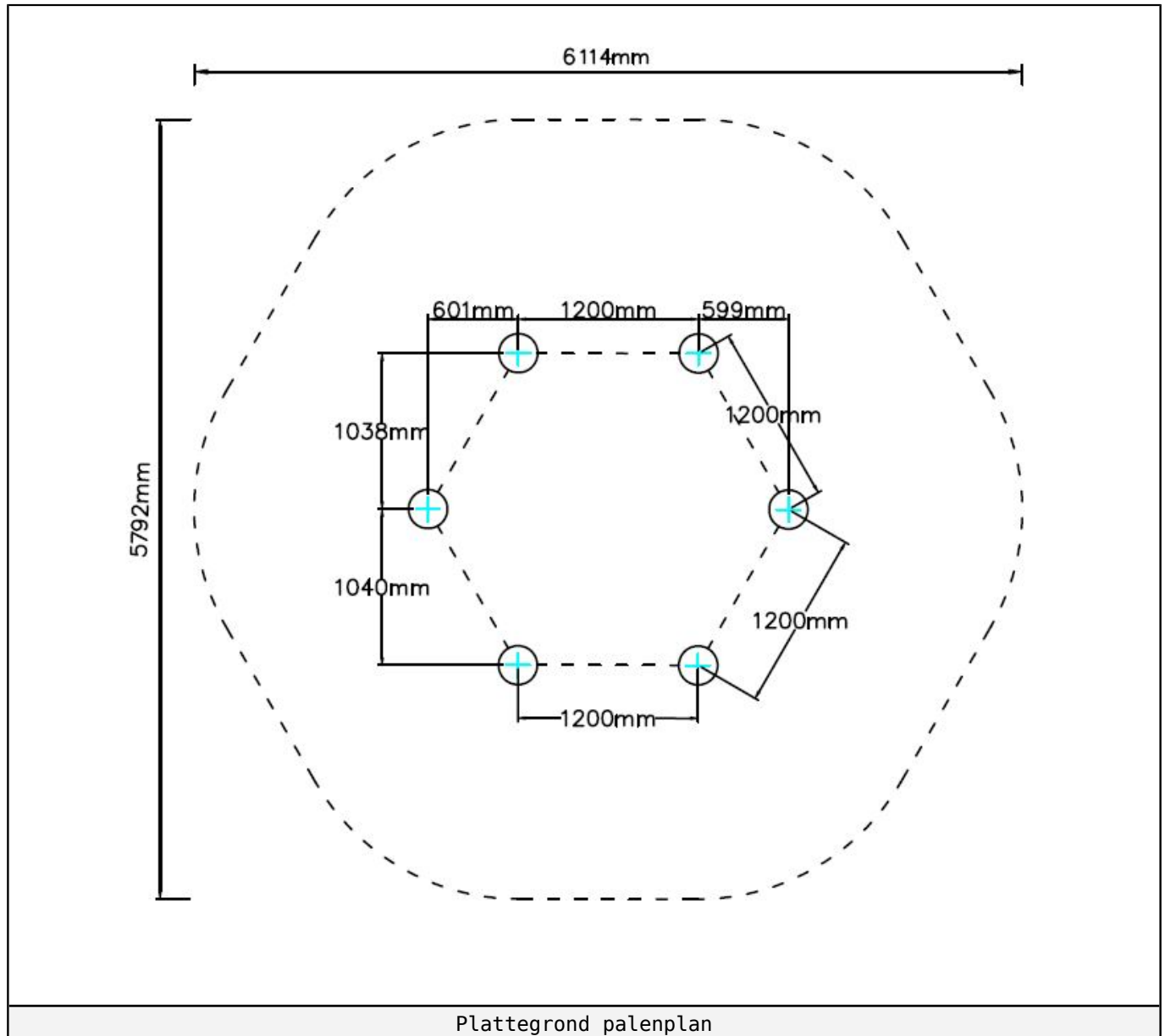

Plattegrond palenplan

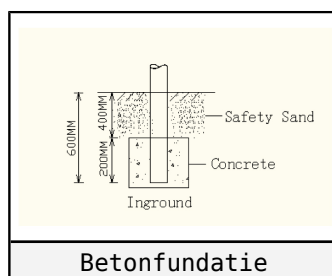

Betonfundatie



Onderdeel handleidingen

Op de volgende pagina's van dit document vindt u alle individuele onderdelen met bijhorende technische tekeningen en eventuele montage instructies.



Staander K-435

6 STUKS

Hoofdafmetingen: 260xØ11,4cm

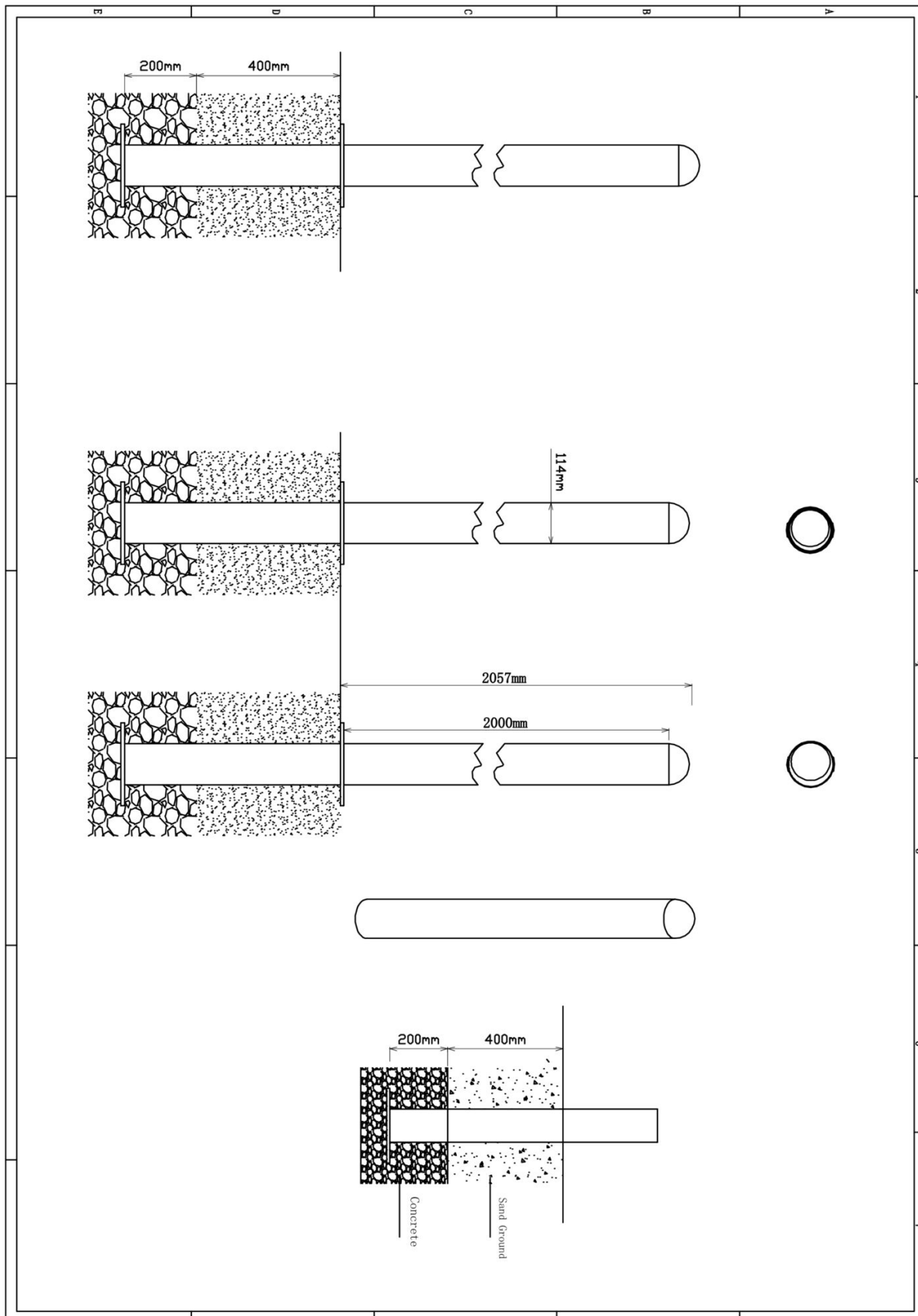

Staander K-435

STAP 1 van 3

Omschrijving: Paalkap losdraaien en opnieuw bevestigen met loctite op het draadeind

1 st. Loctite

1 

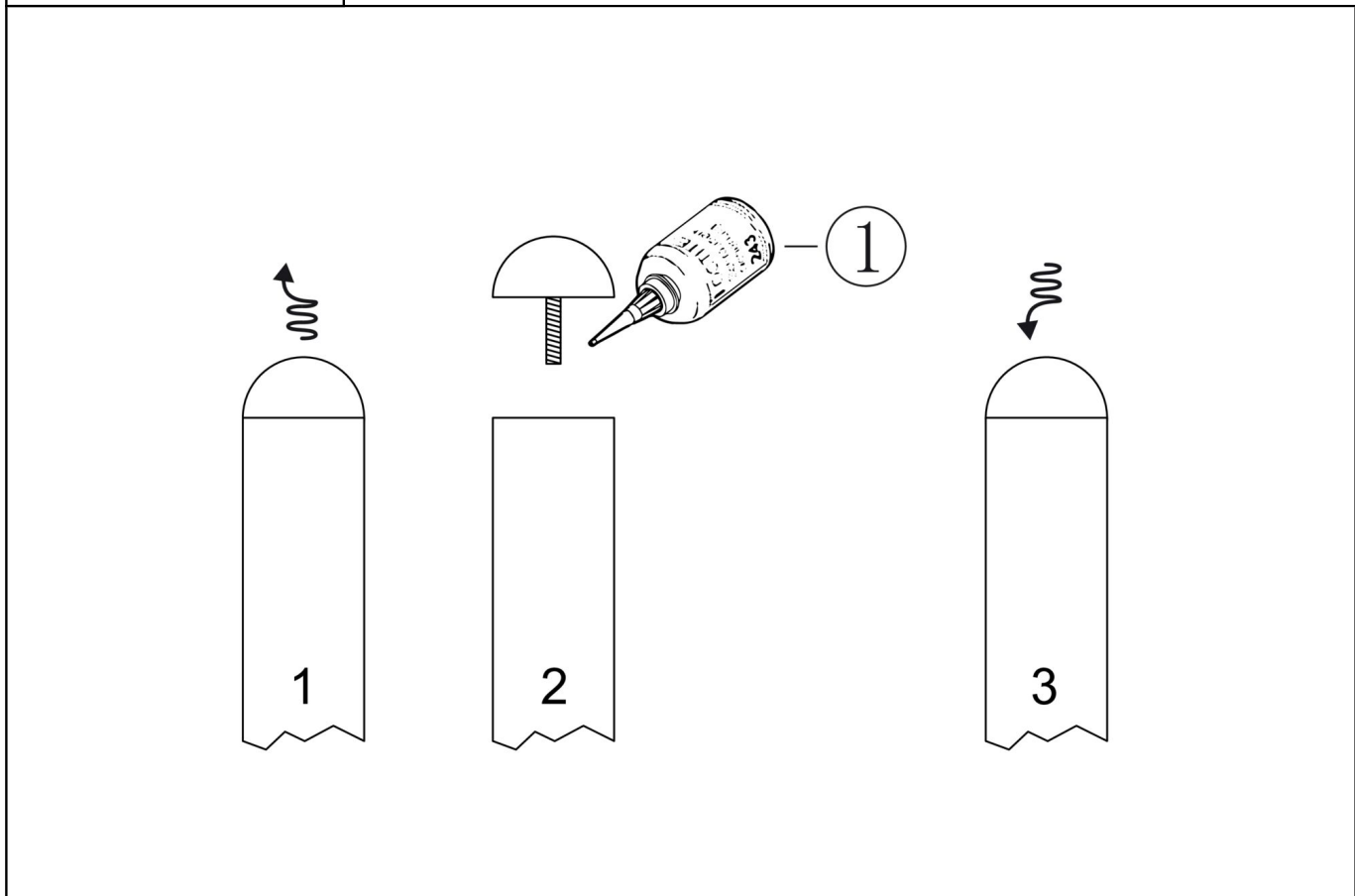

Bevestigings materiaal is per zakje verpakt en bovenstaande afbeelding zit in het zakje

Staander K-435

STAP 2 van 3

Omschrijving: Zelftap bouten aanbrengen aan de binnenkant van de palen.

1 st. Zeskant M3X16 Zelftap

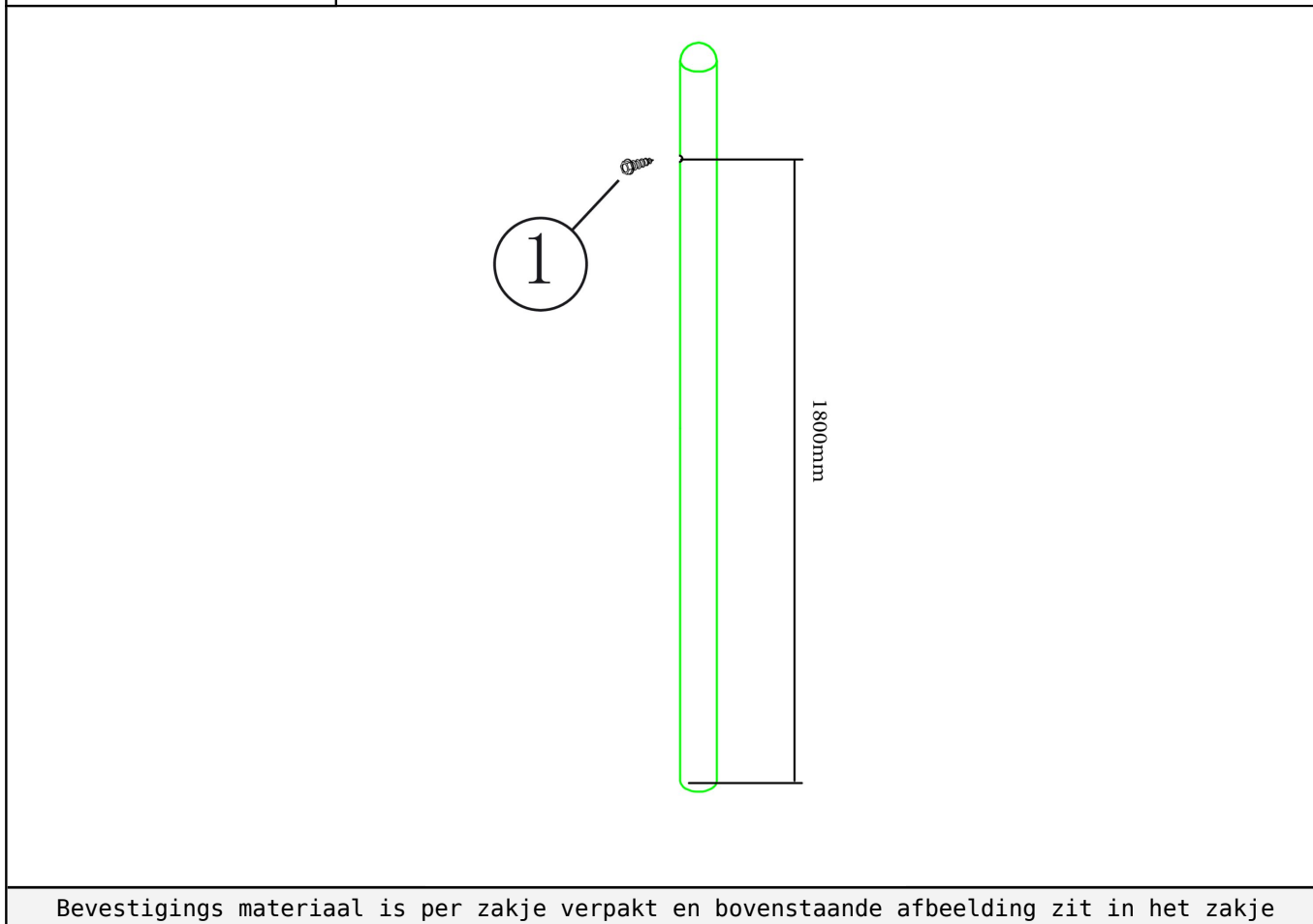

Staander K-435

STAP 3 van 3

Omschrijving: Koppelingsring over de schroef schuiven en vastzetten zodat de schroef niet meer zichtbaar is en de ring door de schroef niet kan zakken op de paal

1 st. Small clamp + ring



Bevestigings materiaal is per zakje verpakt en bovenstaande afbeelding zit in het zakje



Verticale Ladder K-435

1 STUK

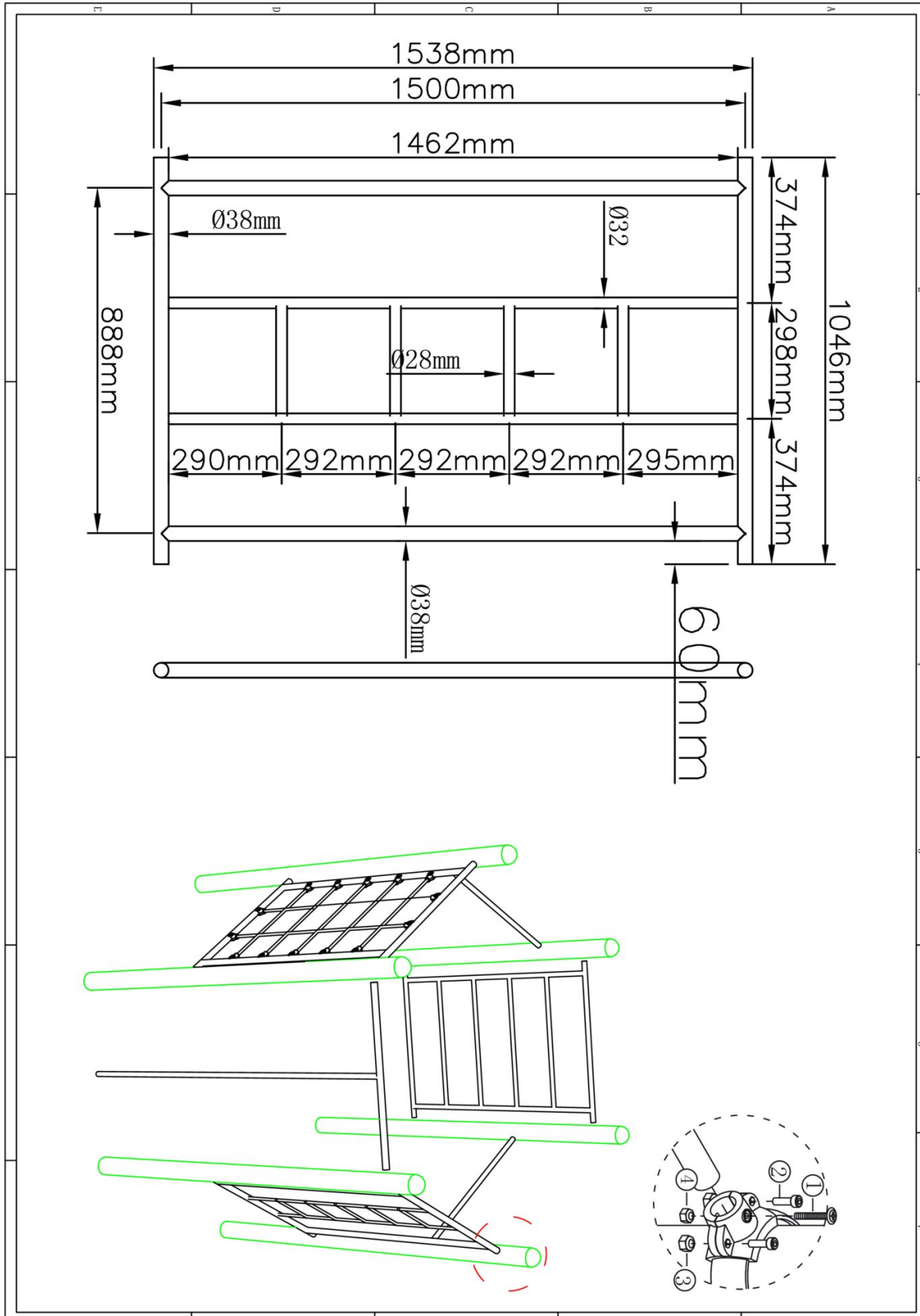

Hoofdafmetingen: 154x105x4cm



Verticale Ladder K-435

STAP 1 van 2

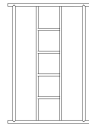
Omschrijving: Ladder aan de staanders vastzetten met behulp van de klemmen

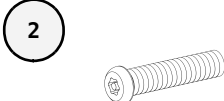
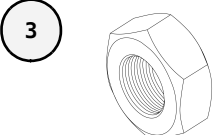
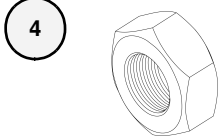
1 st. Verticale Ladder K-435	2 st. Kruiskop M6X65	4 st. Torx M8X20	4 st. Lock Moer M8
			
2 st. Lock Moer M6			
			

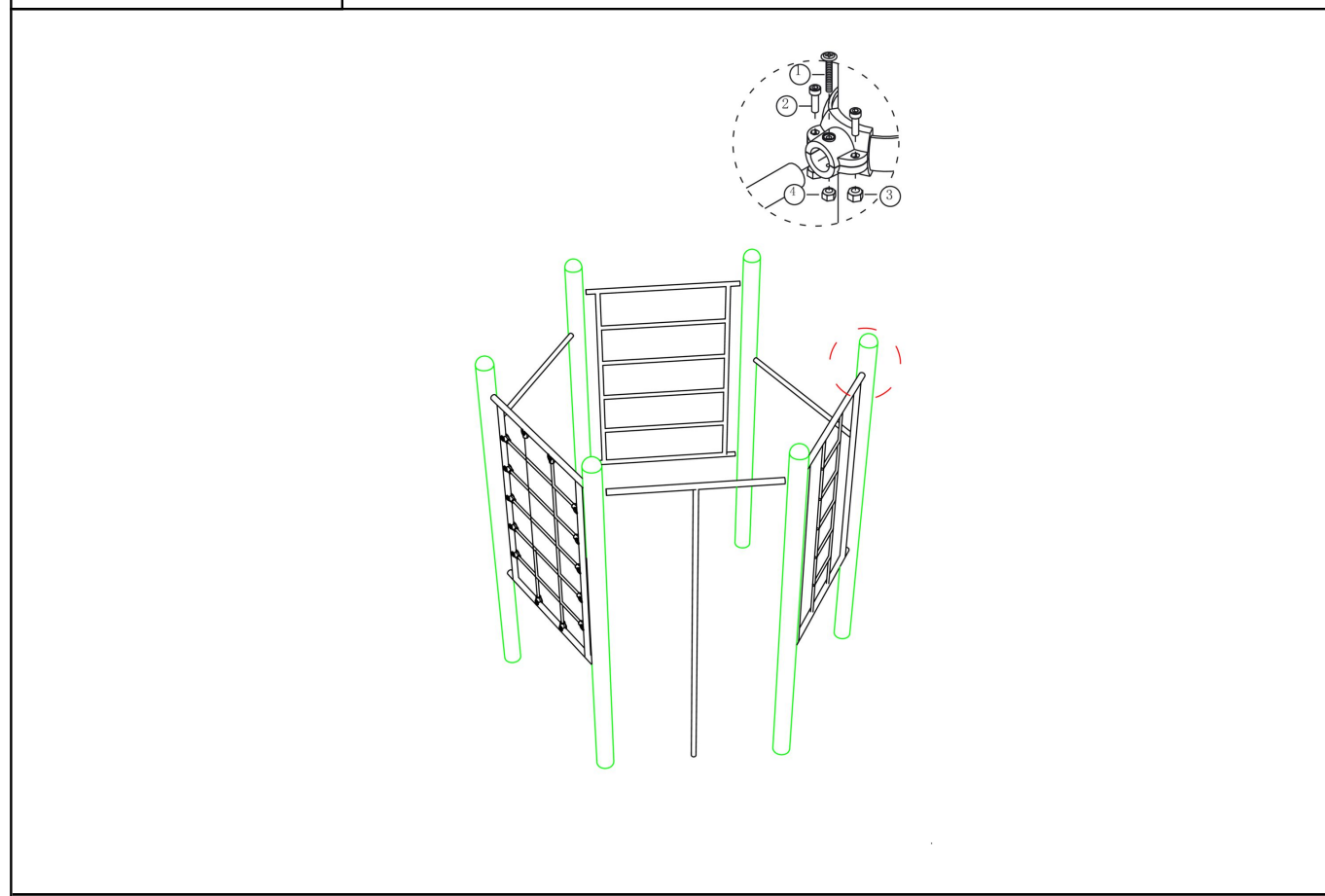





Bevestigings materiaal is per zakje verpakt en bovenstaande afbeelding zit in het zakje

Verticale Ladder K-435

STAP 2 van 2

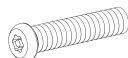
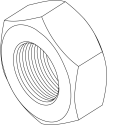
Omschrijving: Ladder vastzetten aan de staanders

2 st. Small clamp + ring	2 st. Kruiskop M6X65	4 st. Torx M8X20
	1 	2 
4 st. Lock Moer M8	2 st. Lock Moer M6	
3 	4 	

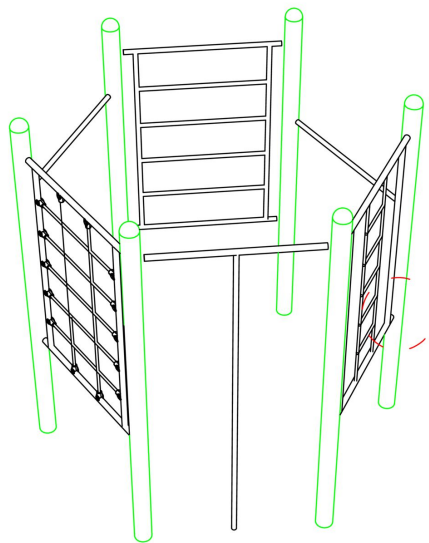
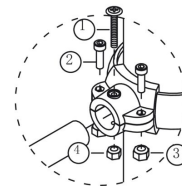

Bevestigings materiaal is per zakje verpakt en bovenstaande afbeelding zit in het zakje



Stangenopgang K-435

1 STUK

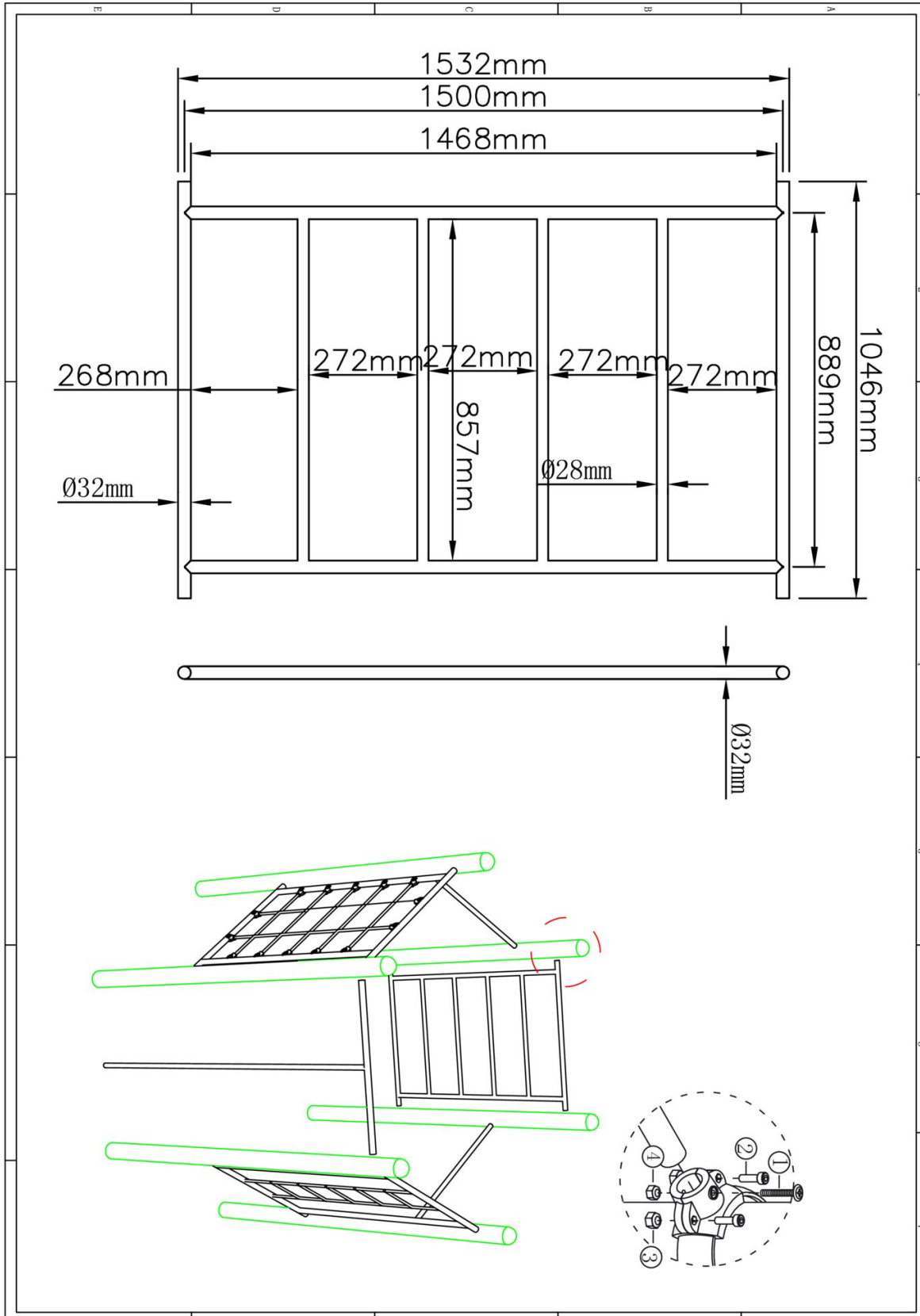

Hoofdafmetingen: 153x105x4cm



Stangenopgang K-435

STAP 1 van 2

Omschrijving: Opgang aan de staanders vastzetten met behulp van de klemmen

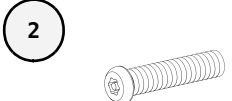
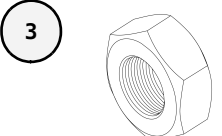
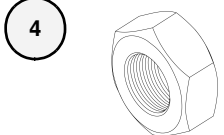
1 st. Stangenopgang K-435	2 st. Kruiskop M6X65	4 st. Torx M8X20	4 st. Lock Moer M8
			
2 st. Lock Moer M6			
			

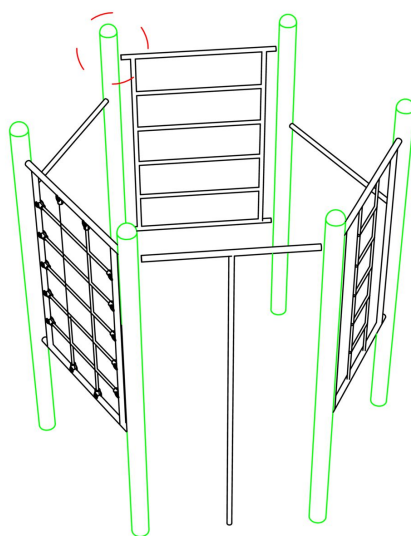
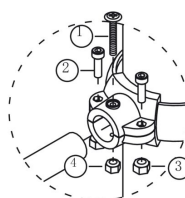





Bevestigings materiaal is per zakje verpakt en bovenstaande afbeelding zit in het zakje

Stangenopgang K-435

STAP 2 van 2

Omschrijving: Opgang vastzetten aan de staanders

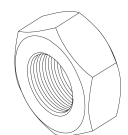
2 st. Small clamp + ring	2 st. Kruiskop M6X65	4 st. Torx M8X20
	1 	2 
4 st. Lock Moer M8	2 st. Lock Moer M6	
3 	4 	

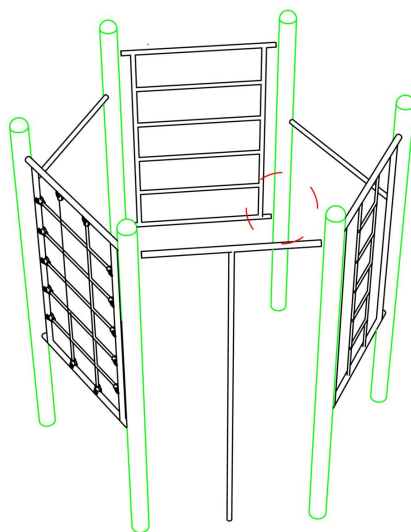
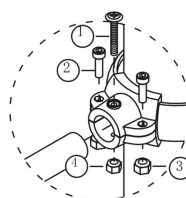



Bevestigings materiaal is per zakje verpakt en bovenstaande afbeelding zit in het zakje

Klimnet K-435

STAP 1 van 2

Omschrijving: Klimnet aan de staanders vastzetten met behulp van de klemmen

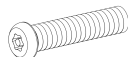
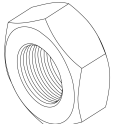
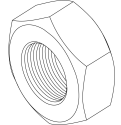
1 st. Klimnet K-435	2 st. Kruiskop M6X65	4 st. Torx M8X20	4 st. Lock Moer M8
			
2 st. Lock Moer M6			
			

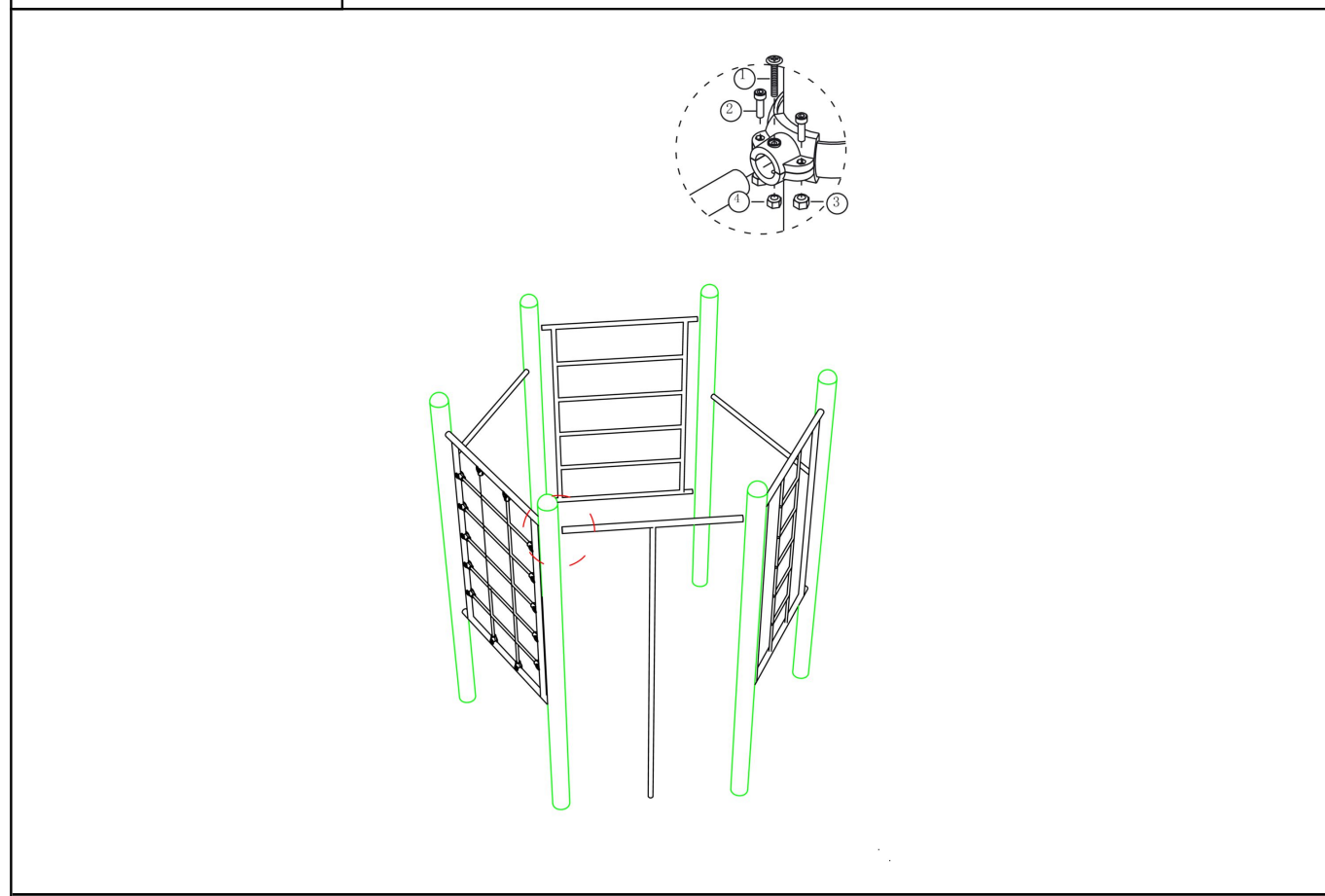



Bevestigings materiaal is per zakje verpakt en bovenstaande afbeelding zit in het zakje

Klimnet K-435

STAP 2 van 2

Omschrijving: Klimnet vastzetten aan de staanders

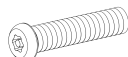
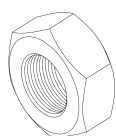
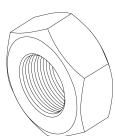
2 st. Small clamp + ring	2 st. Kruiskop M6X65	4 st. Torx M8X20
		
4 st. Lock Moer M8	2 st. Lock Moer M6	
		

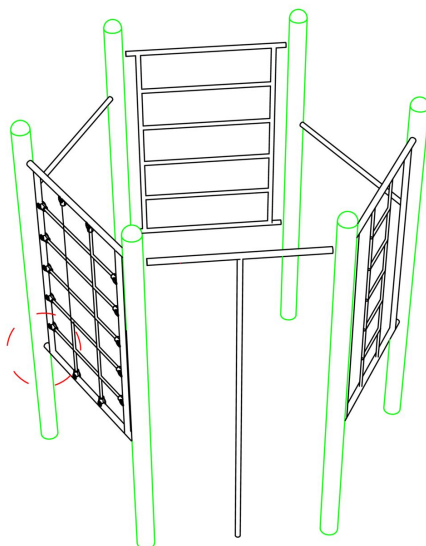
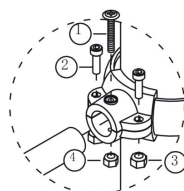

Bevestigings materiaal is per zakje verpakt en bovenstaande afbeelding zit in het zakje

Glijstang K-435

1 STUK

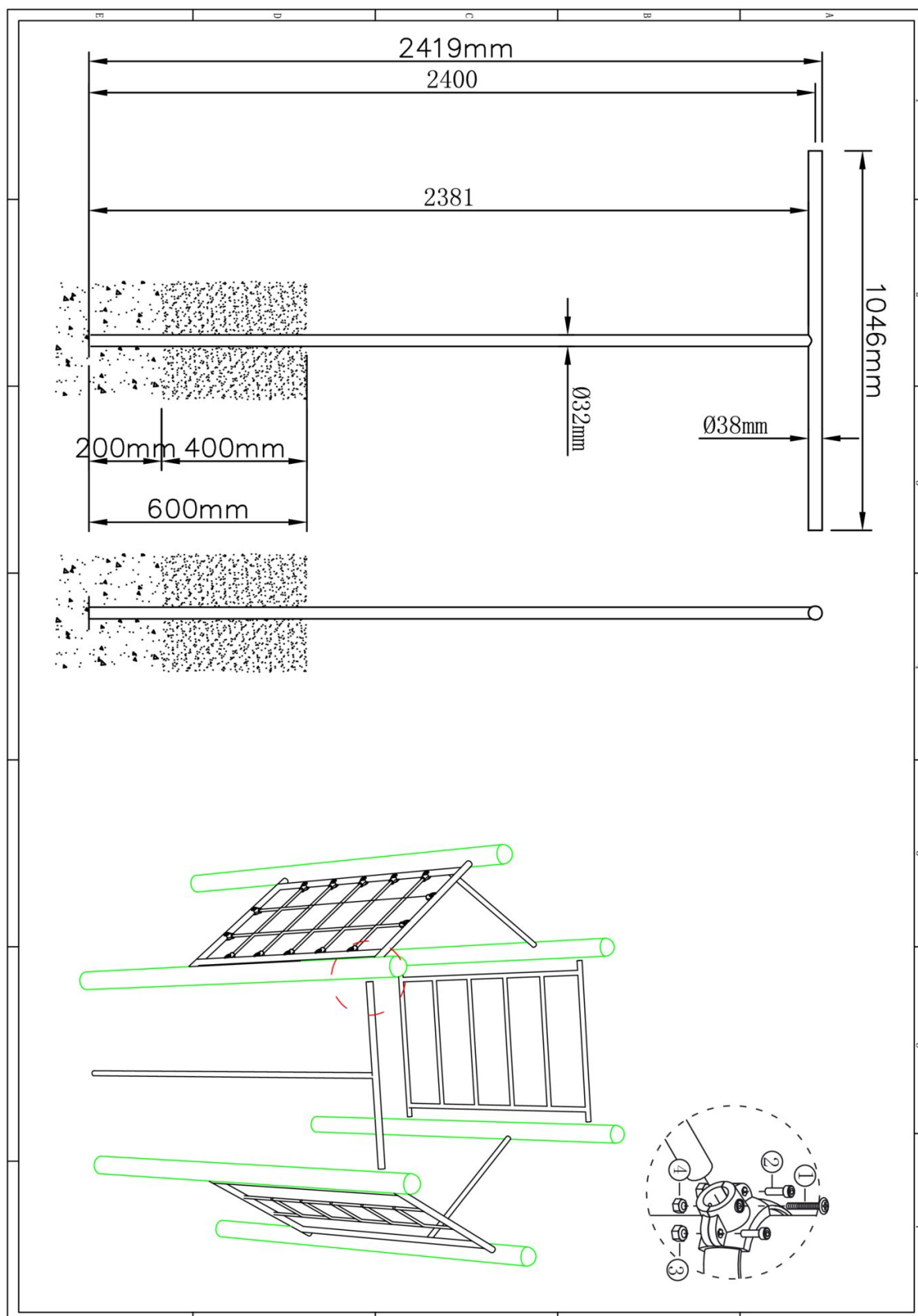

Hoofdafmetingen: 242x105x4cm



Glijstang K-435

STAP 1 van 1

Omschrijving: Ladder aan de staanders vastzetten met behulp van de klemmen

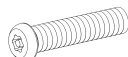
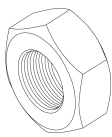
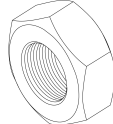
1 st. Glijstang K-435	2 st. Kruiskop M6X65	4 st. Torx M8X20	4 st. Lock Moer M8
			
2 st. Lock Moer M6			
			

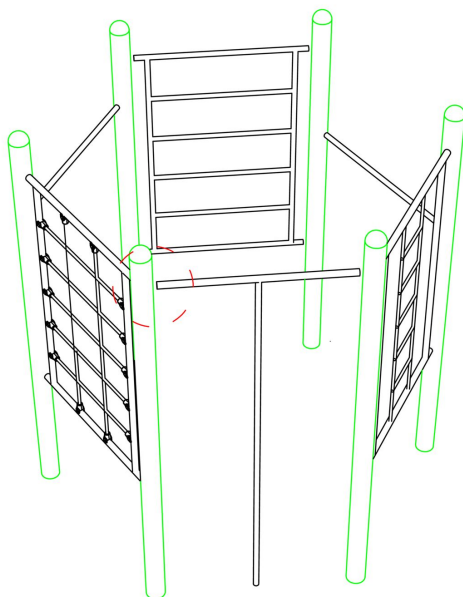
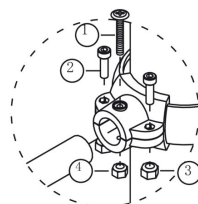

Bevestigings materiaal is per zakje verpakt en bovenstaande afbeelding zit in het zakje

Stang K-435 (hoogte 120cm)

1 STUK

Hoofdafmetingen: 105xØ3,2cm

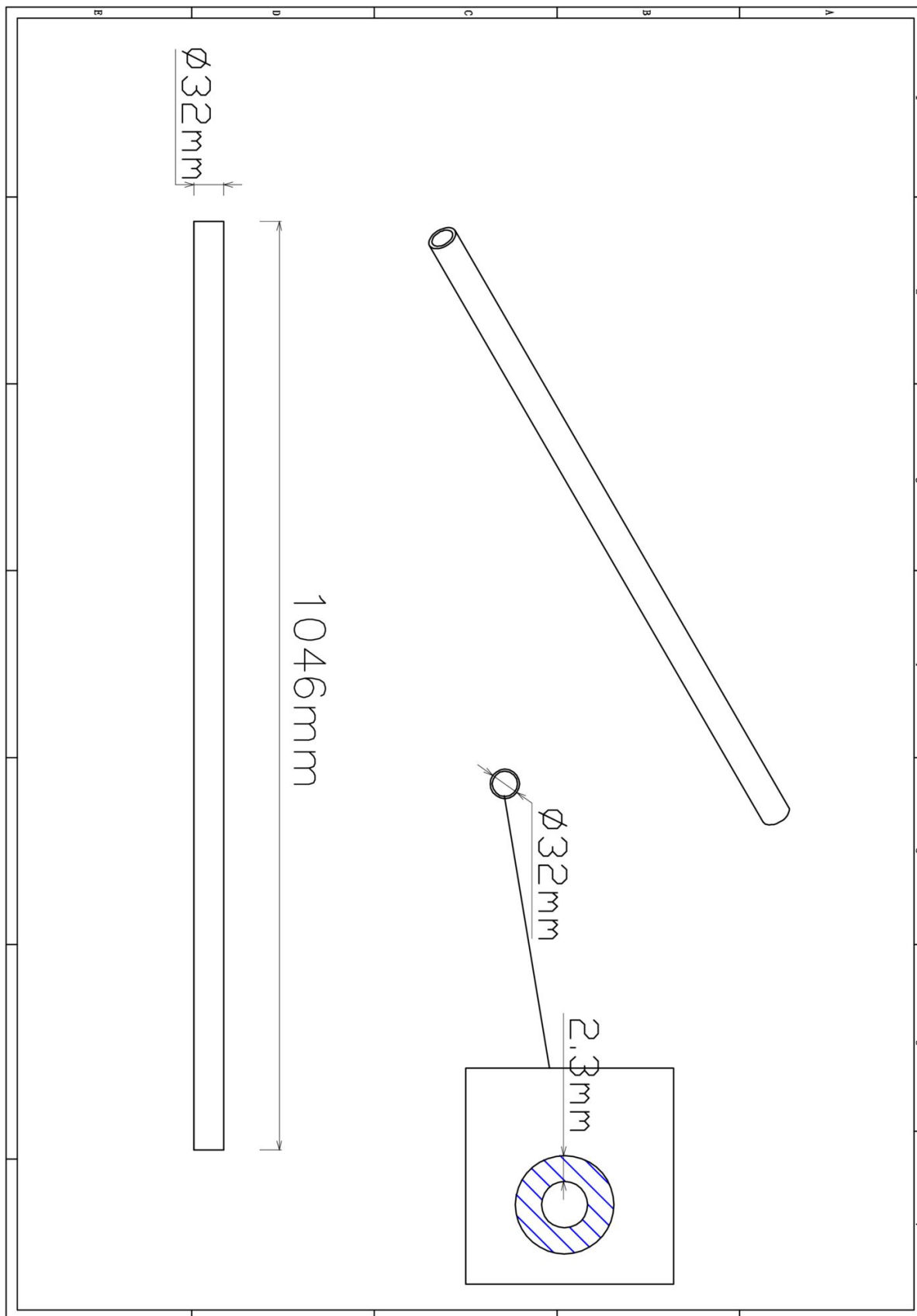

Stang K-435 (hoogte 120cm)

STAP 1 van 3

Omschrijving: Zelftap bouten aanbrengen aan de binnenkant van de palen

2 st. Zeskant M3X16 Zelftap

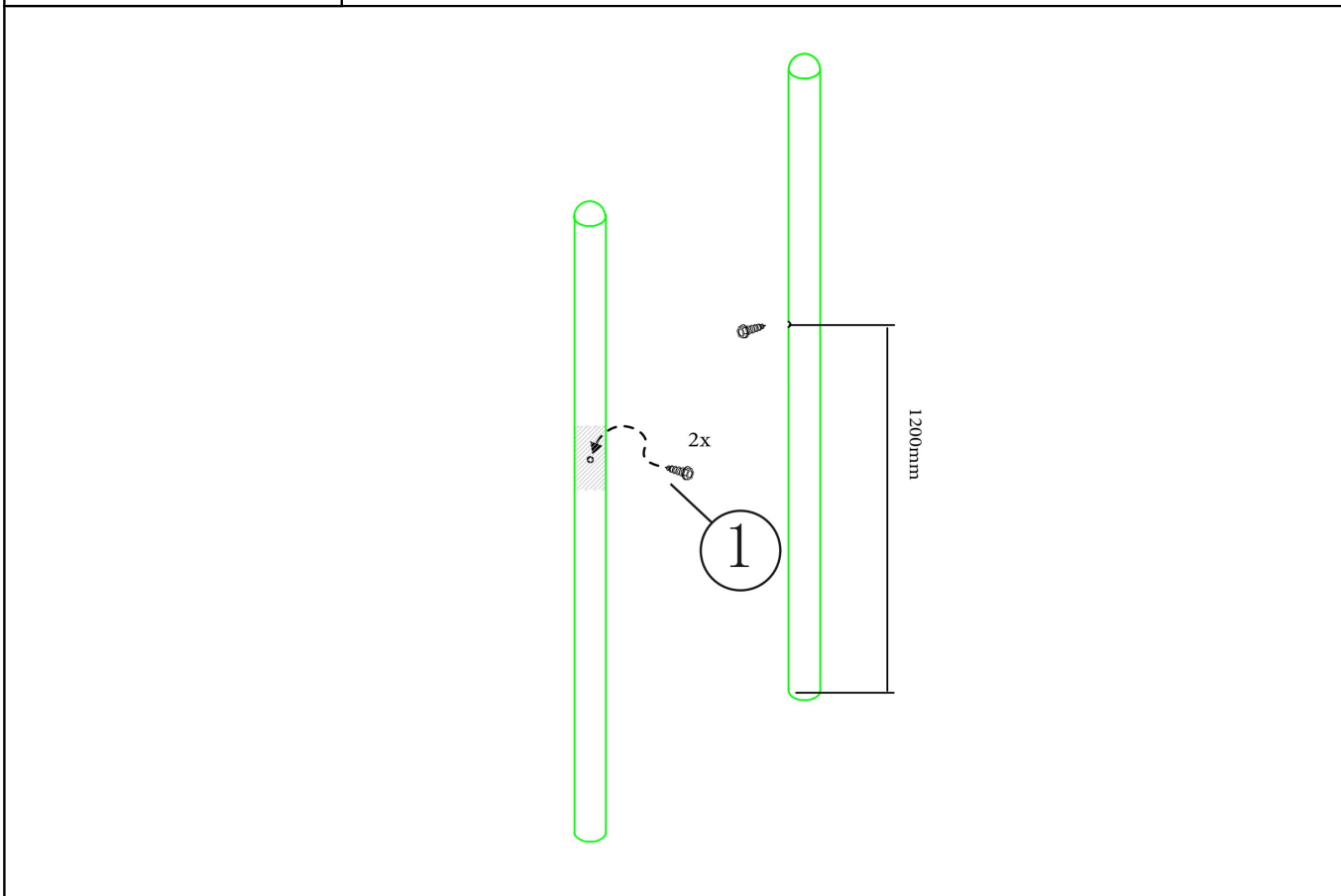
Bevestigings materiaal is per zakje verpakt en bovenstaande afbeelding zit in het zakje

Stang K-435 (hoogte 120cm)

STAP 2 van 3

Omschrijving: Koppelingsring over de schroef schuiven en vastzetten zodat de schroef niet meer zichtbaar is en de ring door de schroef niet kan zakken op de paal

2 st. Small clamp + ring

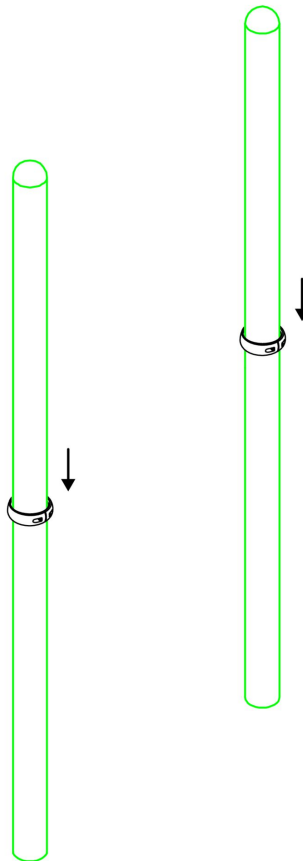



Bevestigings materiaal is per zakje verpakt en bovenstaande afbeelding zit in het zakje

Stang K-435 (hoogte 120cm)

STAP 3 van 3

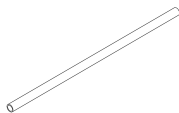
Omschrijving: Stang vastzetten met behulp van de klemmen

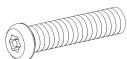
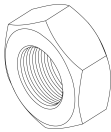
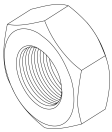
1 st. Stang K-435 (hoogte 120cm)	2 st. Kruiskop M6X65	
		
4 st. Torx M8X20	4 st. Lock Moer M8	2 st. Lock Moer M6
		

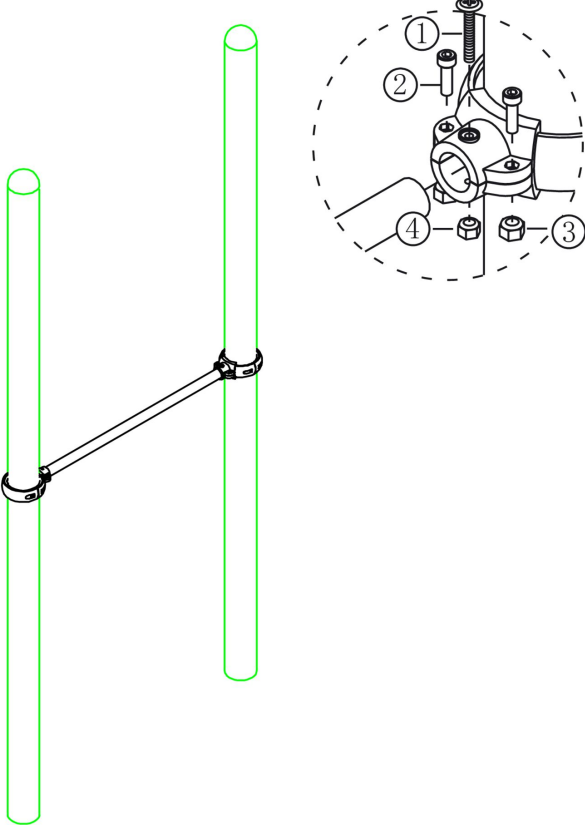

Bevestigings materiaal is per zakje verpakt en bovenstaande afbeelding zit in het zakje



Stang K-435 (hoogte 150cm)

1 STUK

Hoofdafmetingen: 105xØ3,2cm

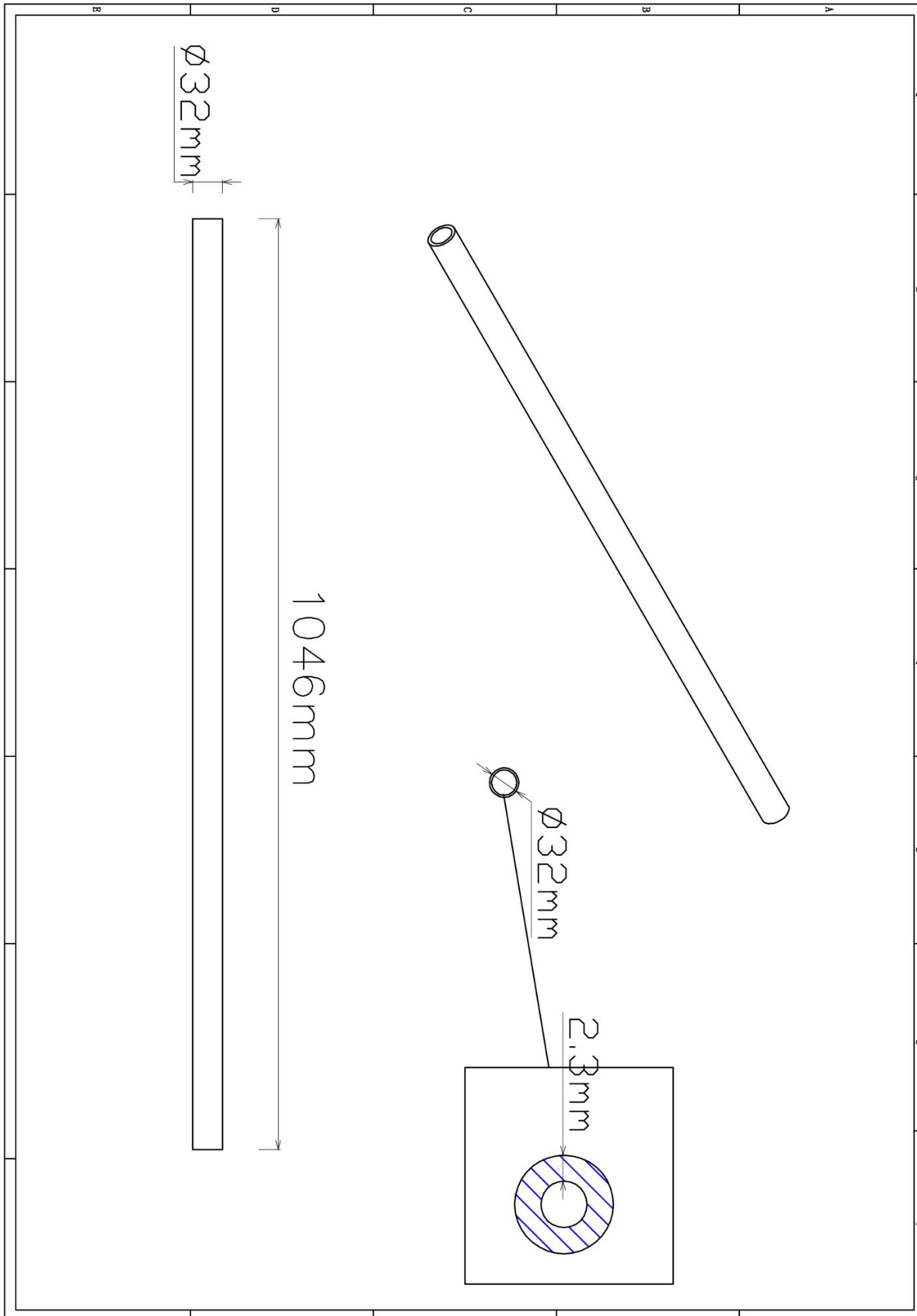

Stang K-435 (hoogte 150cm)

STAP 1 van 3

Omschrijving: Zelftap bouten aanbrengen aan de binnenkant van de palen

2 st. Zeskant M3X16 Zelftap

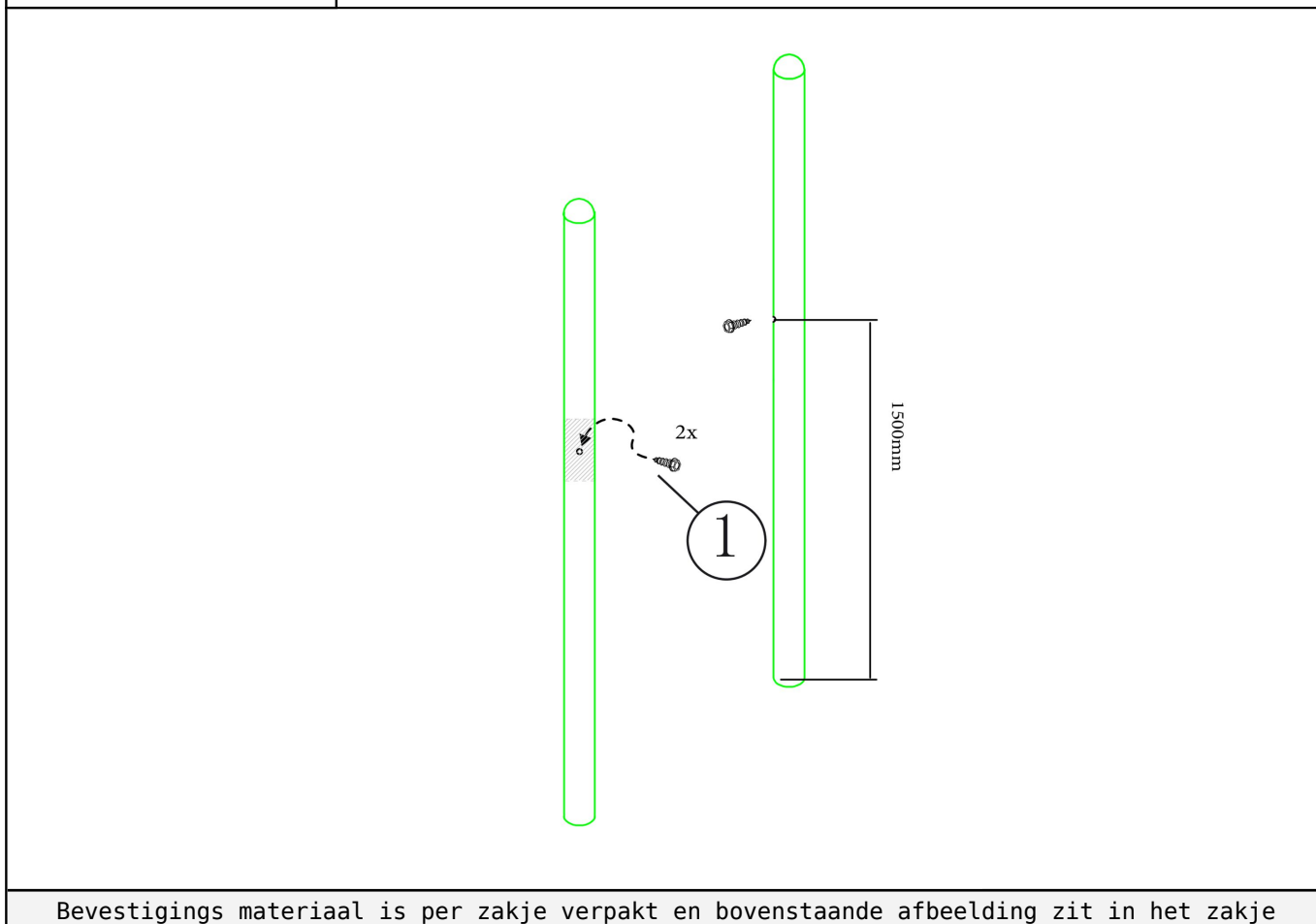

Stang K-435 (hoogte 150cm)

STAP 2 van 3

Omschrijving: Koppelingsring over de schroef schuiven en vastzetten zodat de schroef niet meer zichtbaar is en de ring door de schroef niet kan zakken op de paal

2 st. Small clamp + ring

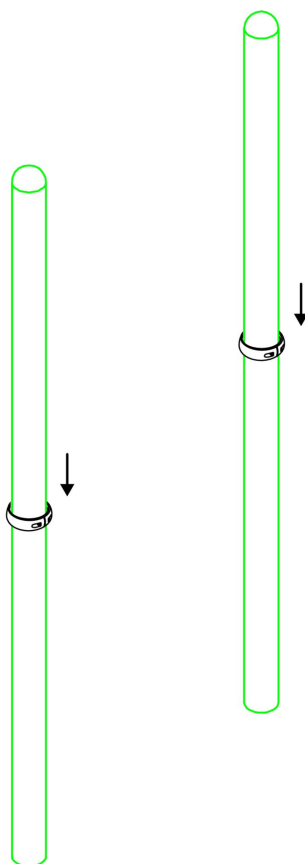



Bevestigings materiaal is per zakje verpakt en bovenstaande afbeelding zit in het zakje

Stang K-435 (hoogte 150cm)

STAP 3 van 3

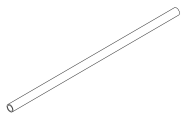
Omschrijving: Stang vastzetten met behulp van de klemmen

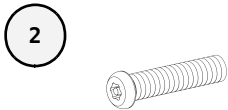
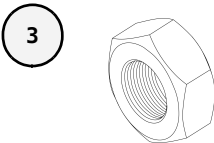
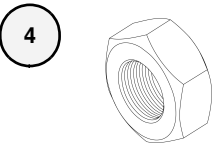
1 st. Stang K-435 (hoogte 150cm)	2 st. Kruiskop M6X65	
		
4 st. Torx M8X20	4 st. Lock Moer M8	2 st. Lock Moer M6
		

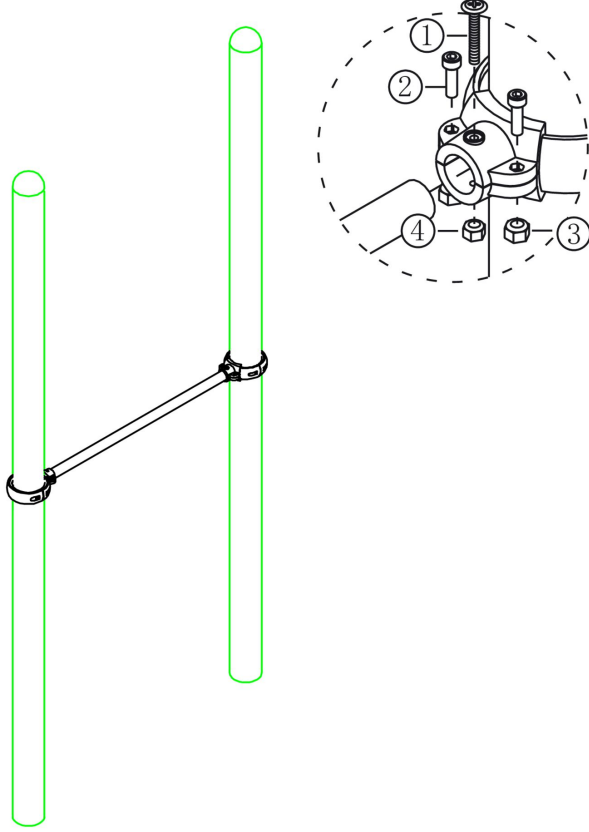

Bevestigings materiaal is per zakje verpakt en bovenstaande afbeelding zit in het zakje