



TnT speeltoestellen

Montagehandleiding PE-S105



Toestel typenummer	PE-S105
Datum montagehandleiding	11/01/2021
Versienummer montagehandleiding	2.0

Beste klant van TnT Speeltoestellen,

Wij danken u voor het aanschaffen en installeren van een speeltoestel van TnT Speeltoestellen. Wij waarderen het vertrouwen dat u in ons bedrijf heeft geplaatst en streven ernaar om uw vertrouwen meer dan waar te maken!

Dit is uw TnT speeltoestellen montagehandleiding.

Wij hebben deze handleiding specifiek voor het product ontworpen, waarop eveneens de toe te passen onderdelen zijn genoemd.

Ook vindt u het grondplan met de benodigde valruimte volgens norm NEN-EN1176-1 : 2017.

Bewaart u dit document bij uw logboek. Nogmaals willen wij u bedanken voor de aankoop van dit speeltoestel. Wij zien uit naar uw volgende speelproject.

Met vriendelijke groet, TnT Speeltoestellen



Inhoudsopgave

Aanzichten 3D	3
Onderdelenlijst	4
Veiligheidsruimtes	5
Aanzichten 2D	6
Plattegrond palenplan	7
Onderdeel handleidingen	8
<i>Staander 240cm tbv dak PE</i>	9
<i>Staander 160cm PE toestel</i>	10
<i>PE Dak met 4 ruiten</i>	12
<i>PE-Slangpaneel</i>	14
<i>PE Planeten paneel</i>	16
<i>PE Autorace paneel</i>	18
<i>PE Kompaspaneel Piraat</i>	20
<i>PE Bankje</i>	22

Aanzichten 3D



Aanzicht 1





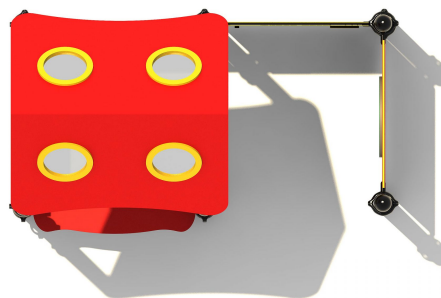



Aanzicht 2

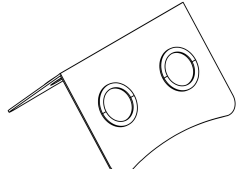
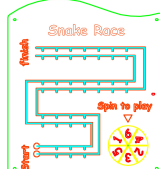

Aanzicht 3

Onderdelenlijst

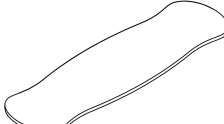
4 st. Staander 240cm tbv dak PE	2 st. Staander 160cm PE toestel	1 st. PE Dak met 4 ruiten	1 st. PE-Slangpaneel
240x8,9	160x8,9	127x118x72cm	90 x 78 x 4cm
			
1 st. PE Planeten paneel	1 st. PE Autorace paneel	1 st. PE Kompaspaneel Piraat	1 st. PE Bankje
100x78x6cm	110x78x4cm	110x78x4cm	76x20x2cm
			

Veiligheidsruimtes

Geachte klant,

Zorg er altijd voor dat alle veiligheids ruimtes zoals aangegeven in ieder geval gehaald worden, dit zijn de minimale vereiste ruimtes voor een veilig gebruik van het speeltoestel.

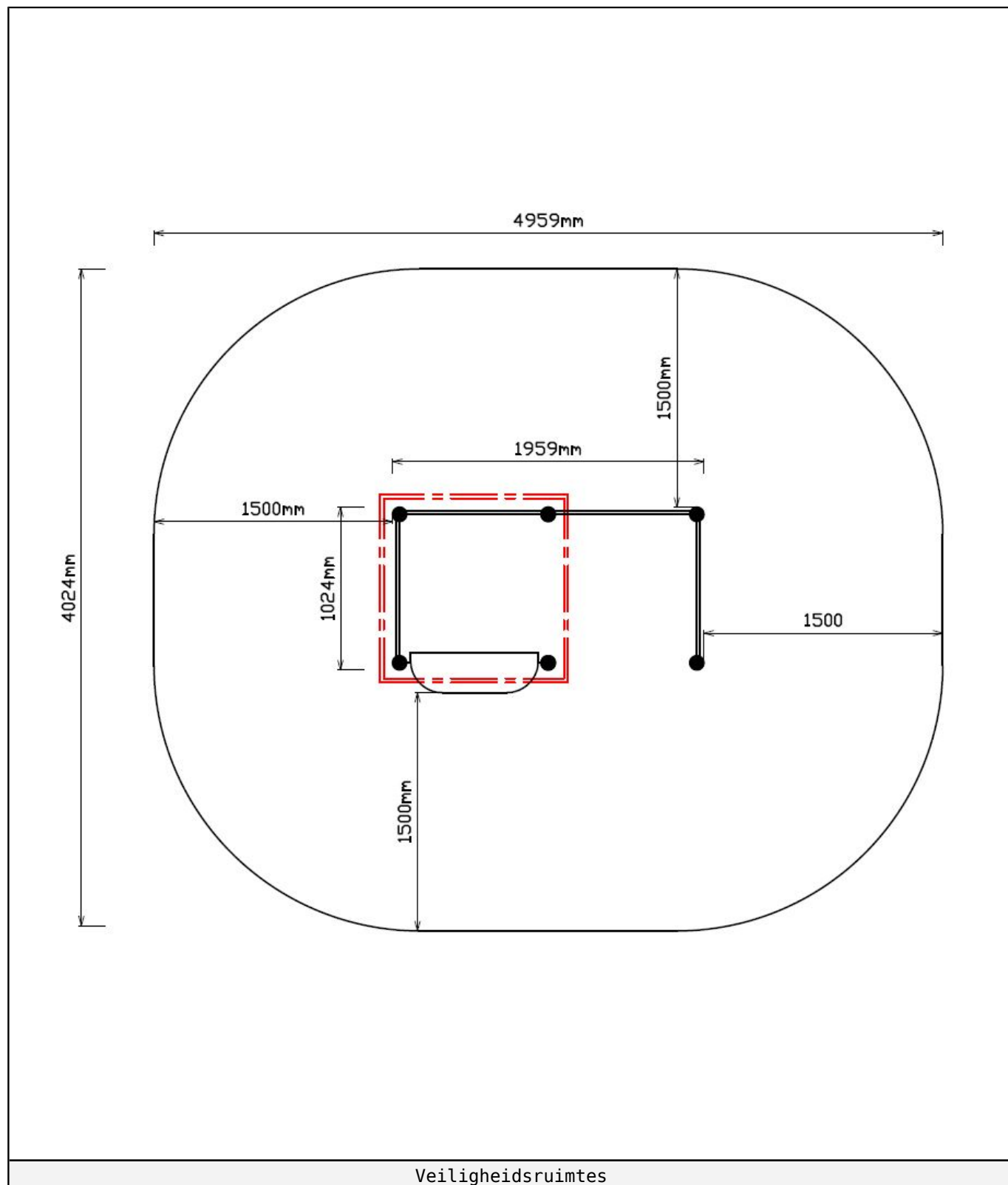

Aanzichten 2D

Hier vindt u de beschikbare aanzichtstekeningen.

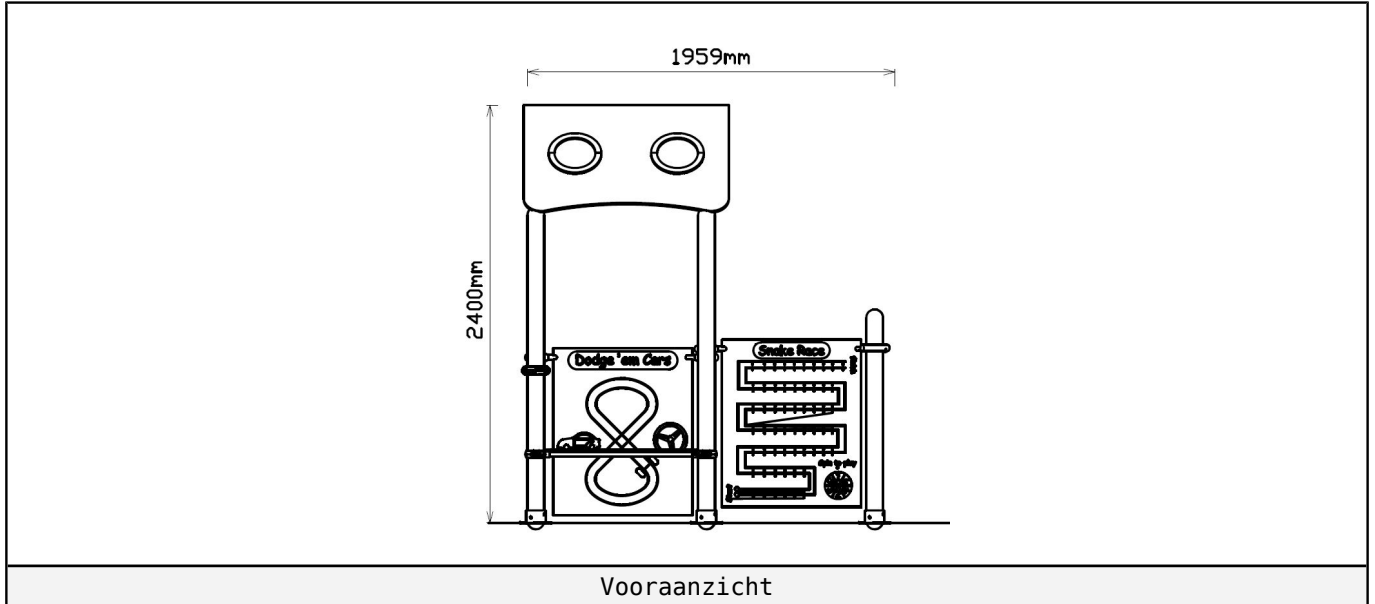

Vooraanzicht

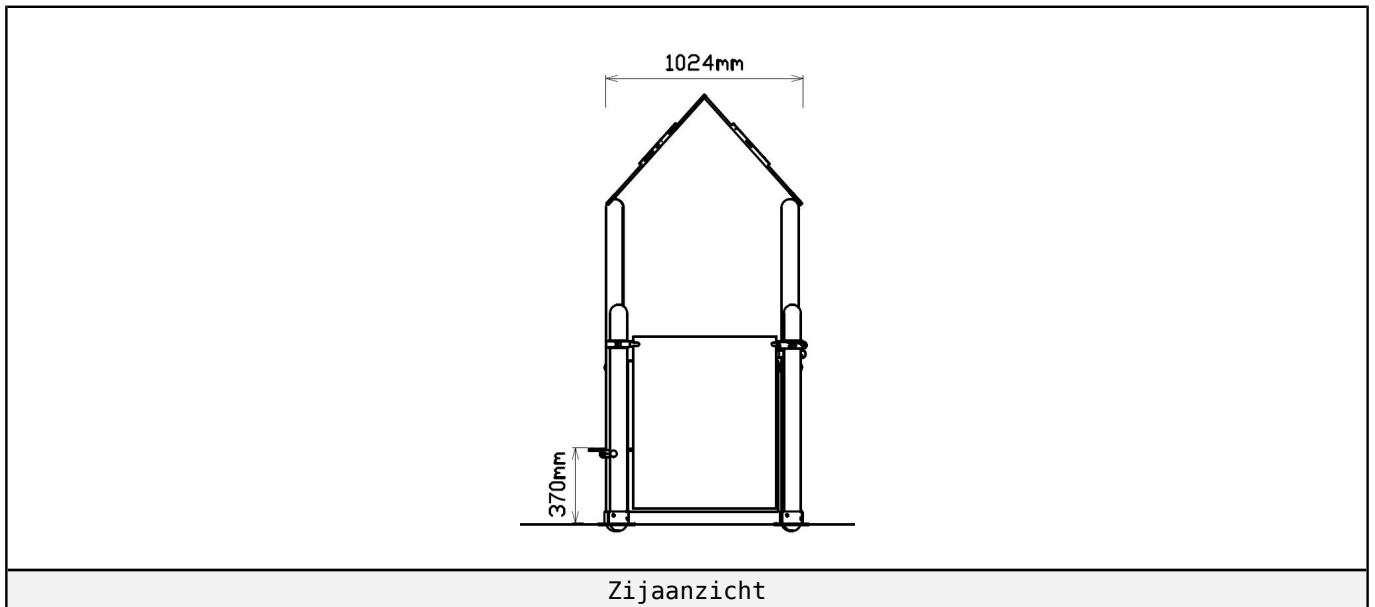

Zijaanzicht

Plattegrond palenplan

U kunt van deze tekening niet afmeten!

Voor de betonfundatie heeft u 37,5 kg snelbeton per staander nodig.

Houdt u er rekening mee dat de betonfundatie minimaal 400mm onder het maaiveld blijft, zoals op de tekening afgebeeld.

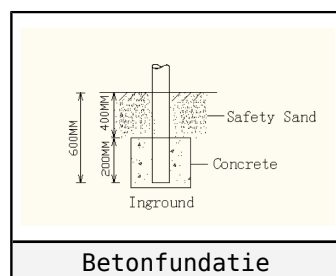
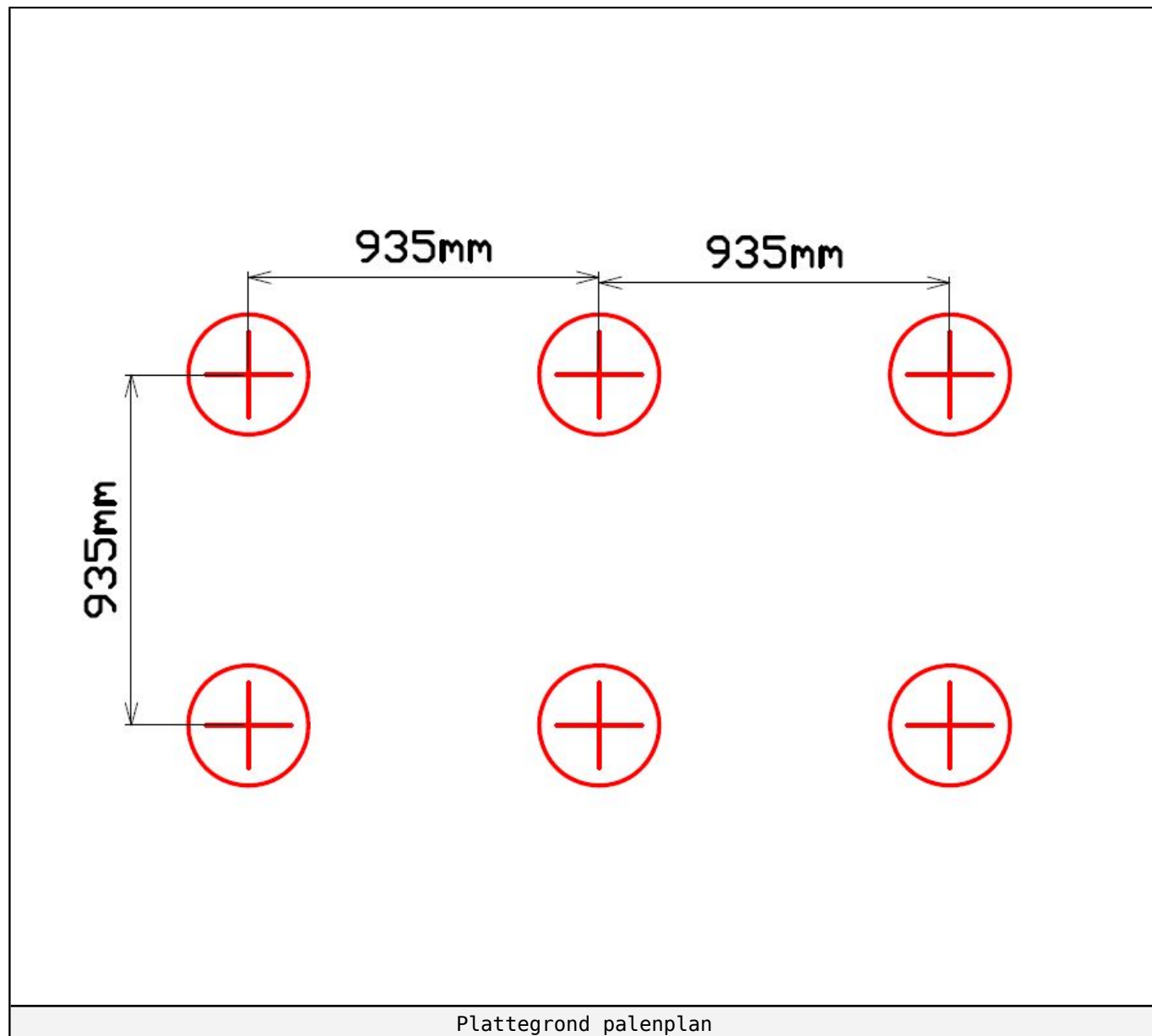

Onderdeel handleidingen

Op de volgende pagina's van dit document vindt u alle individuele onderdelen met bijhorende technische tekeningen en eventuele montage instructies.



Staander 240cm tbv dak PE

4 STUKS

Hoofdafmetingen: 240x8,9

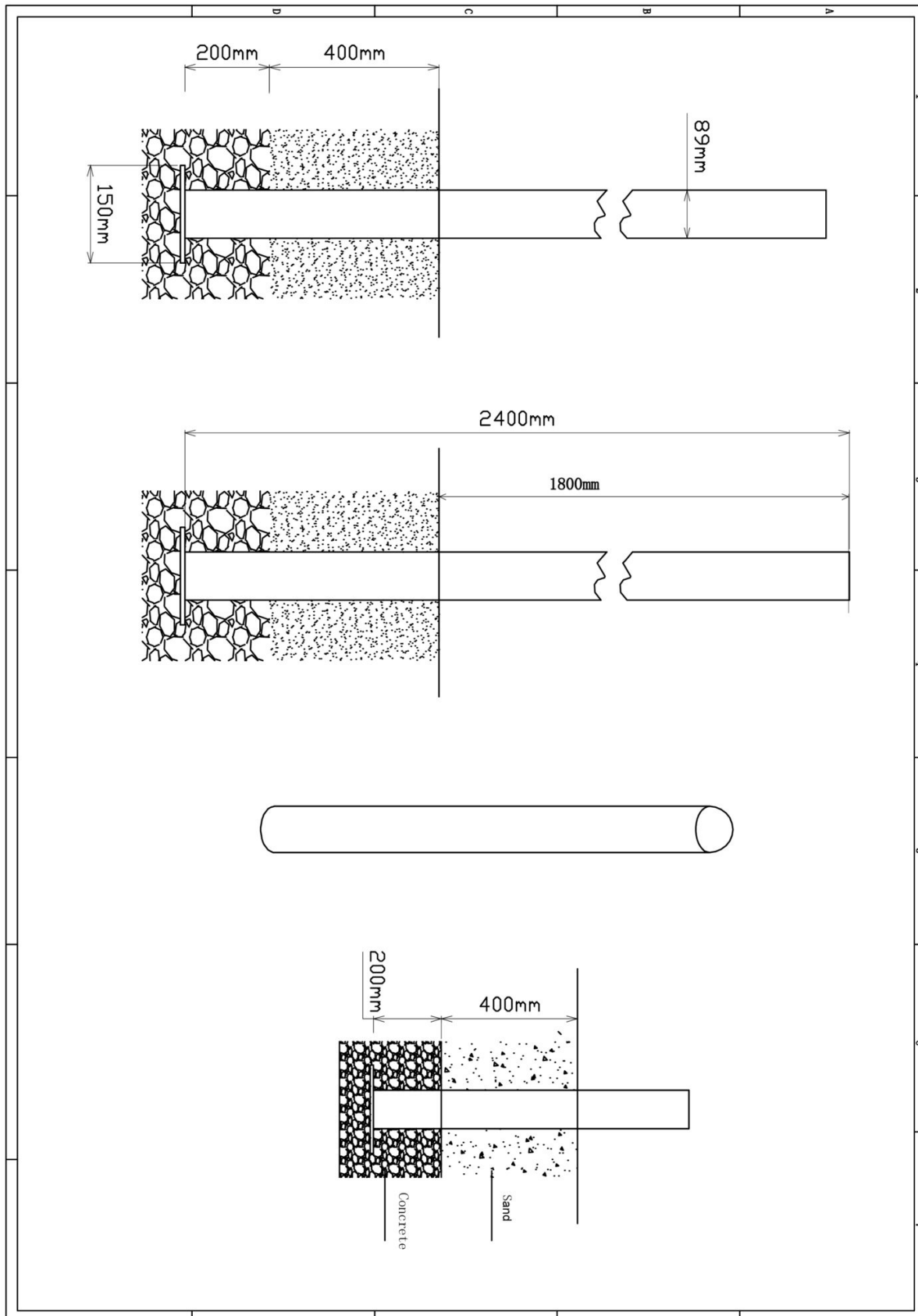



Staander 160cm PE toestel

2 STUKS

Hoofdafmetingen: 160x8,9

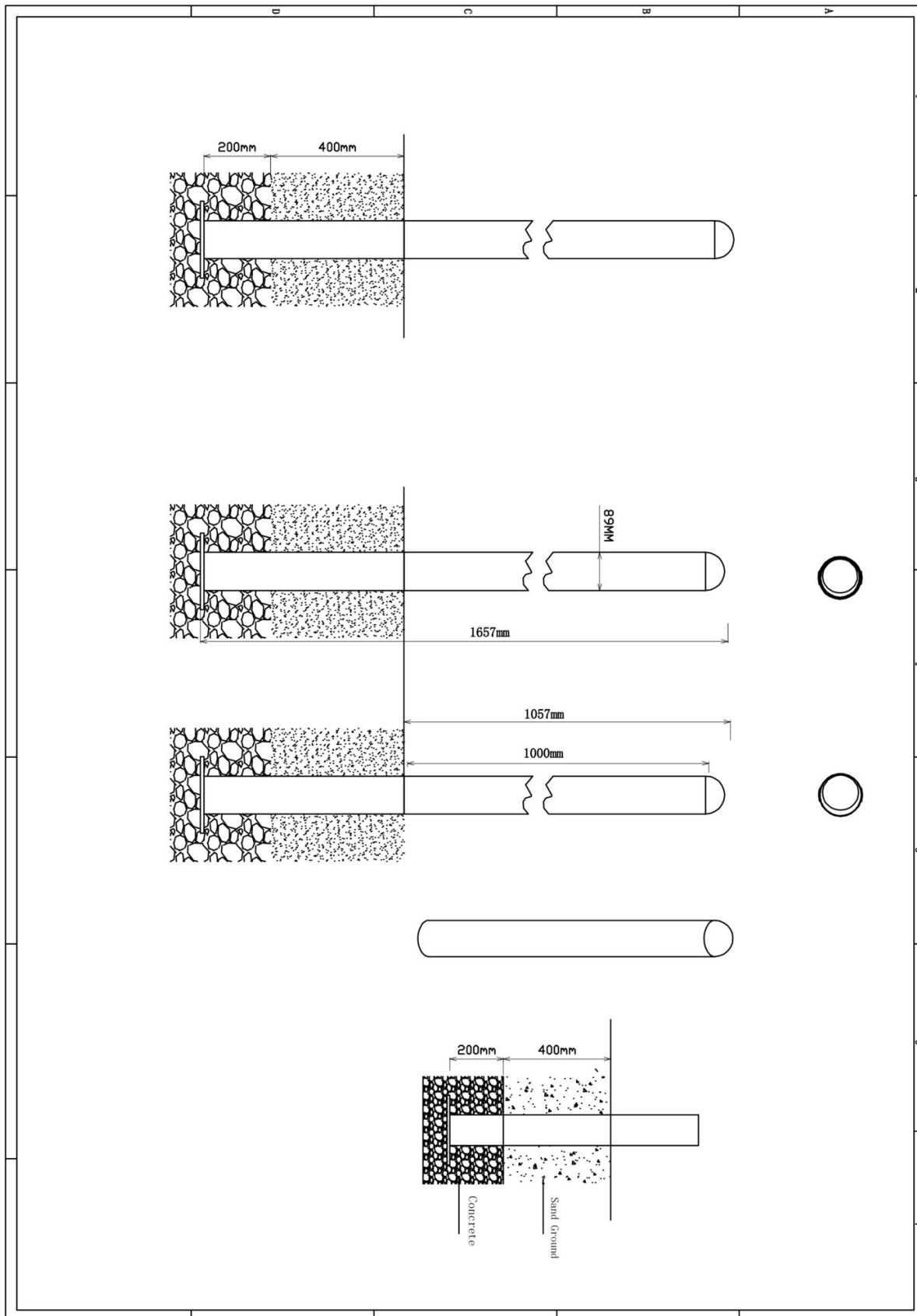

Staander 160cm PE toestel

STAP 1 van 1

Omschrijving: Paalkap losdraaien en opnieuw bevestigen met loctite op het draadeind

1 st. Loctite	
1	

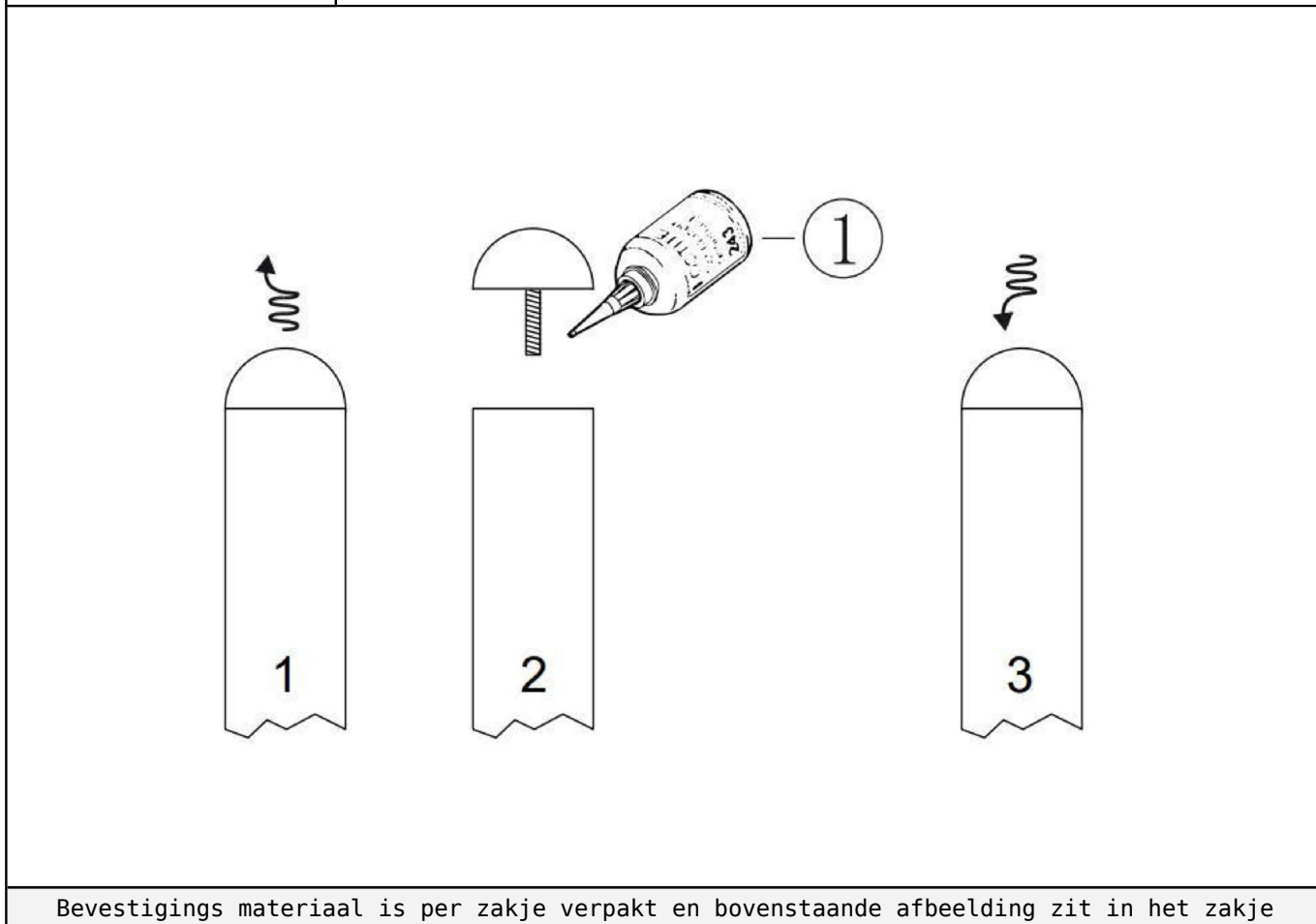



PE Dak met 4 ruiten

1 STUK

Hoofdafmetingen: 127x118x72cm

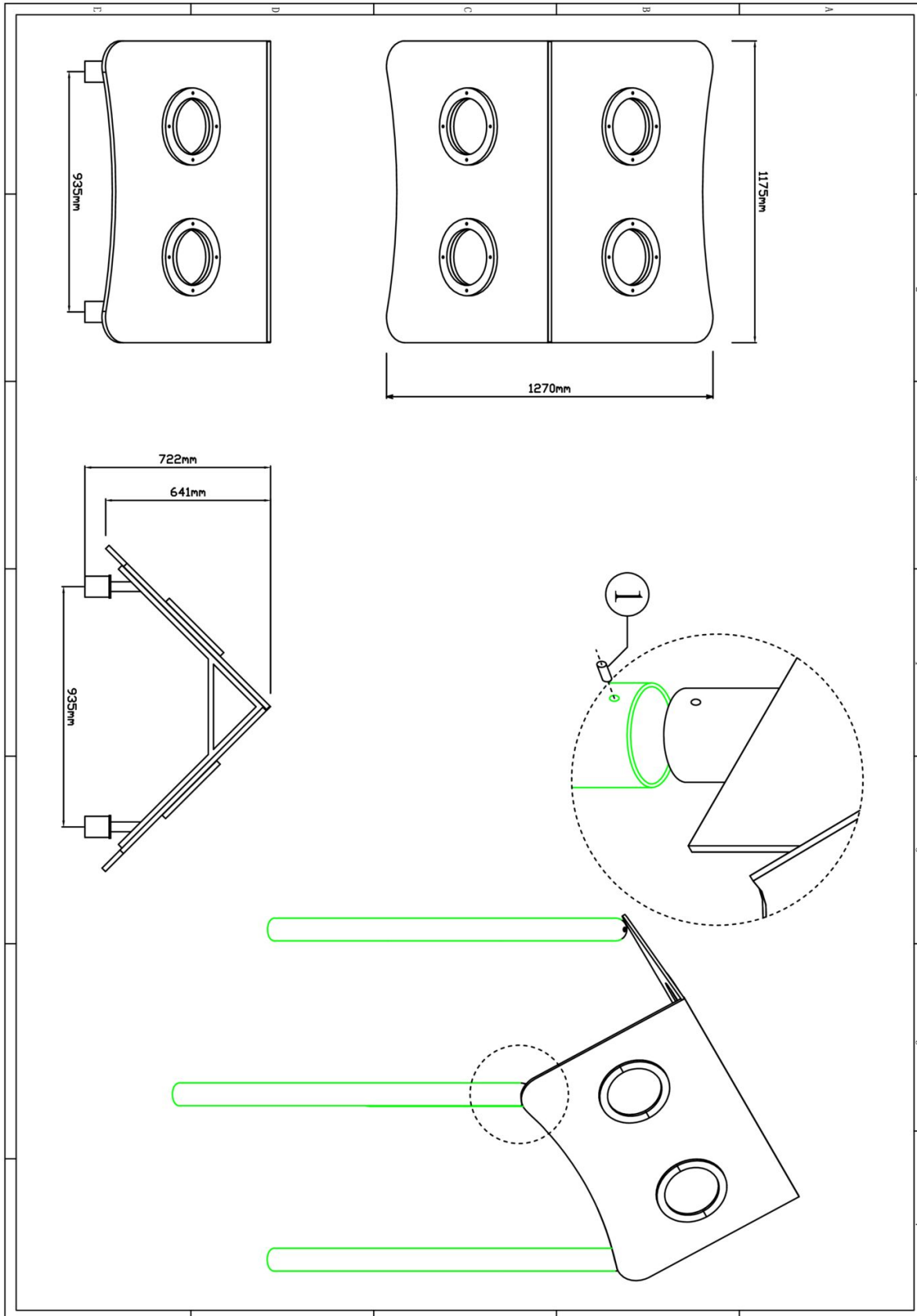

PE Dak met 4 ruiten

STAP 1 van 1

Omschrijving: Schuif het dak op de standers en bevestig met zelftapschroeven

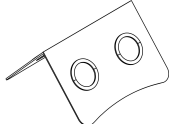
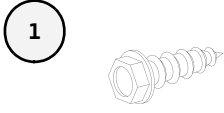
1 st. PE Dak met 4 ruiten	4 st. Zeskant M3X16 Zelftap
	

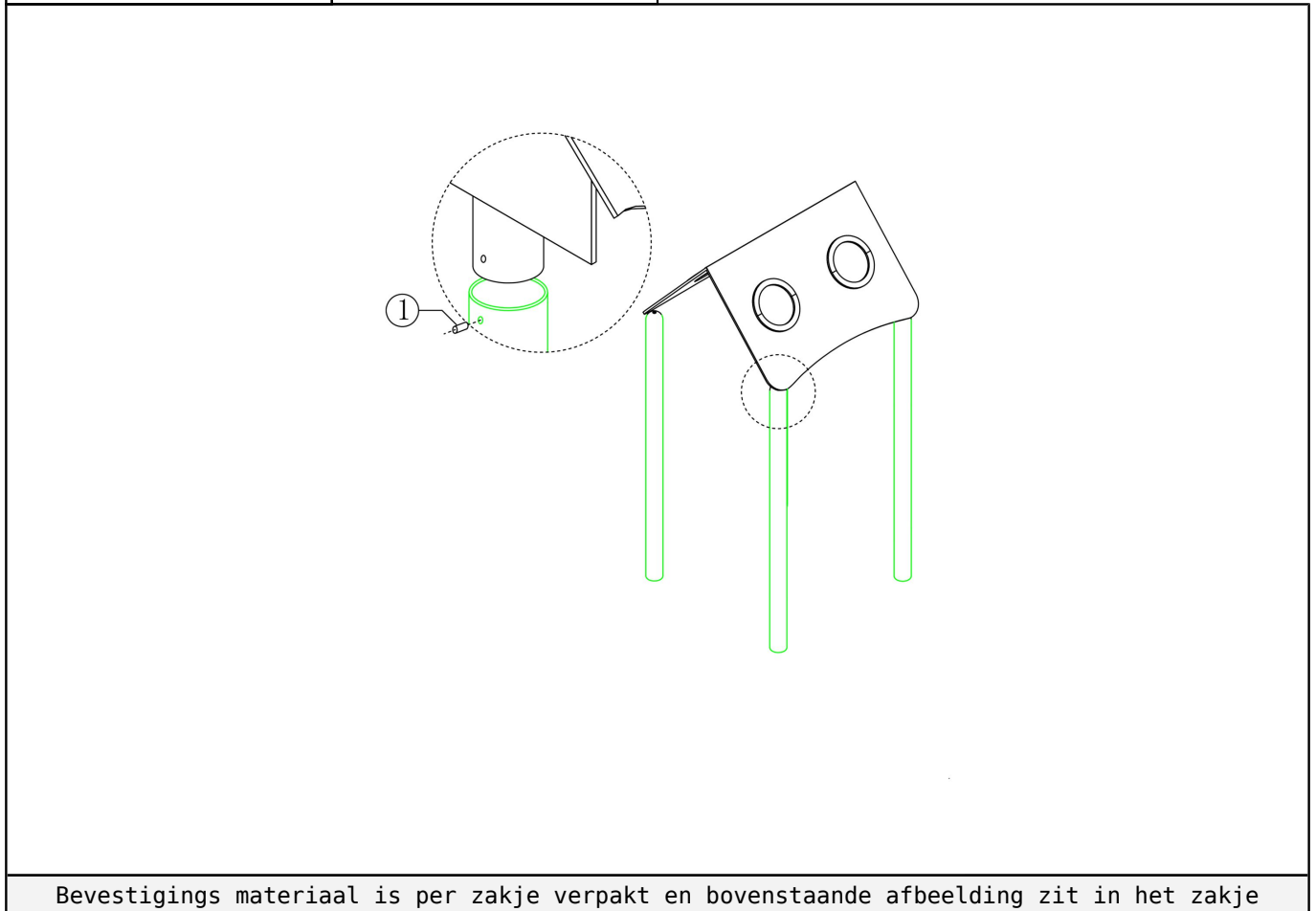



PE-Slangpaneel

1 STUK



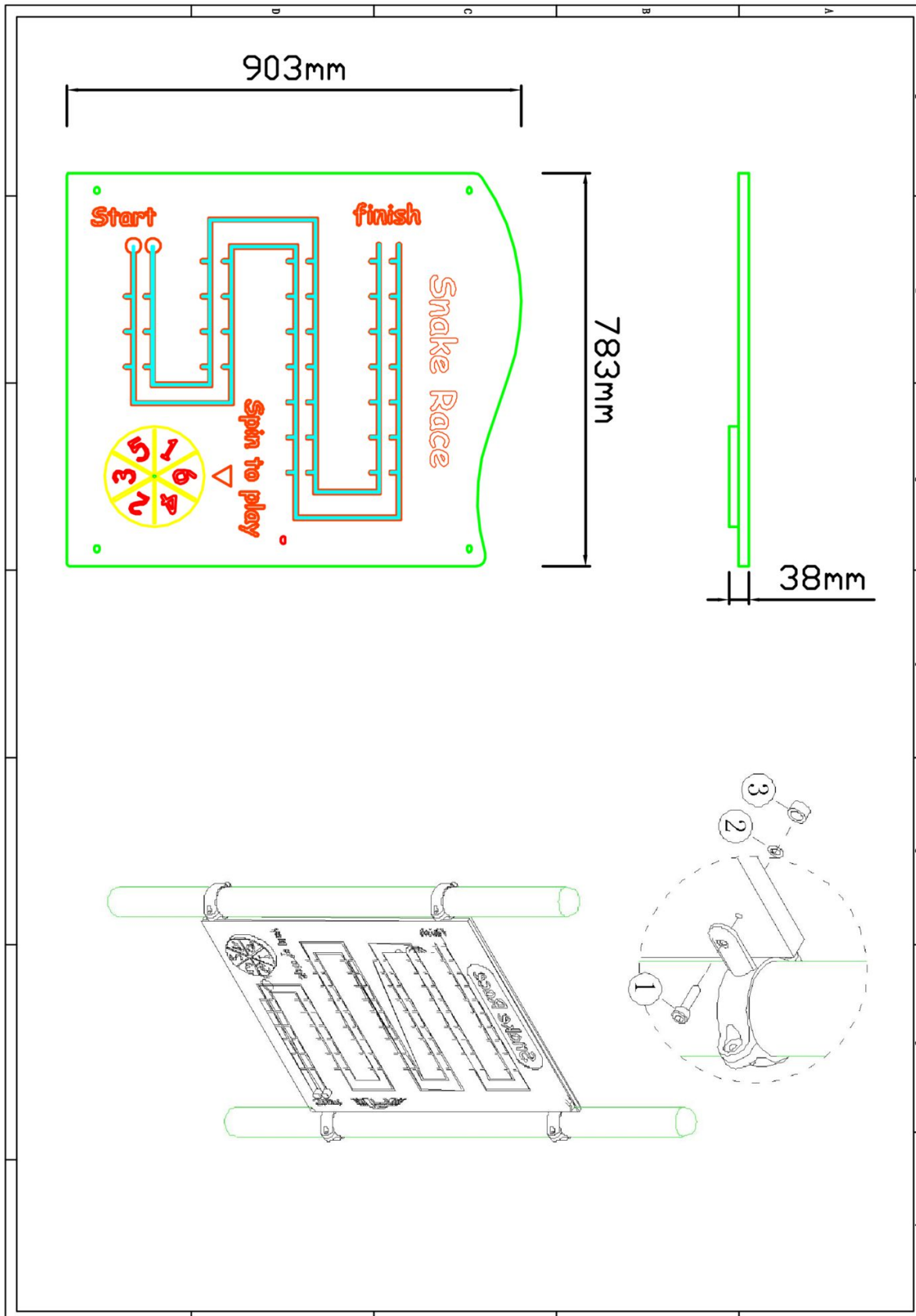



Hoofdafmetingen: 90 x 78 x 4cm

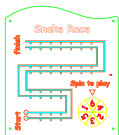
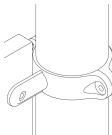
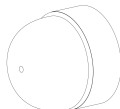
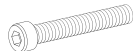

PE-Slangpaneel

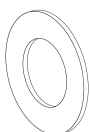
STAP 1 van 1

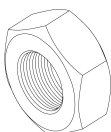
Omschrijving: Bevestiging tussen het paneel en de staanders

1 st. PE-Slangpaneel	4 st. PE-Klem	4 st. Afdekdop M8	4 st. Bout M8X30
			 
4 st. Ring M8 (middel)	4 st. Lock Moer M8		
 	 		

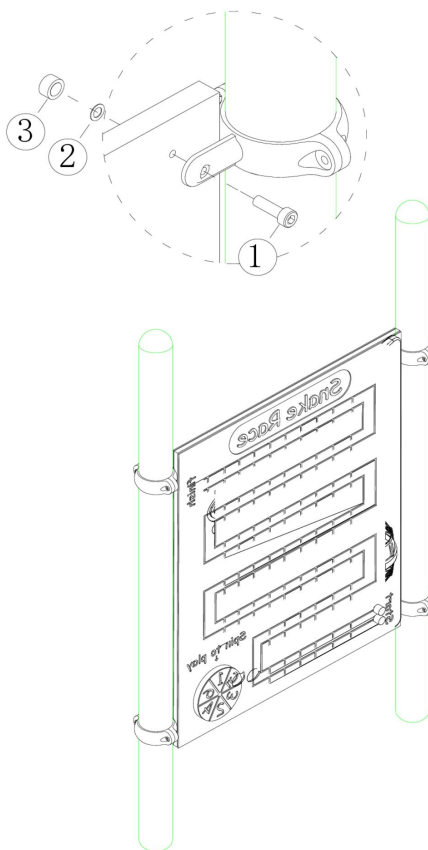

Bevestigings materiaal is per zakje verpakt en bovenstaande afbeelding zit in het zakje



PE Planeten paneel

1 STUK

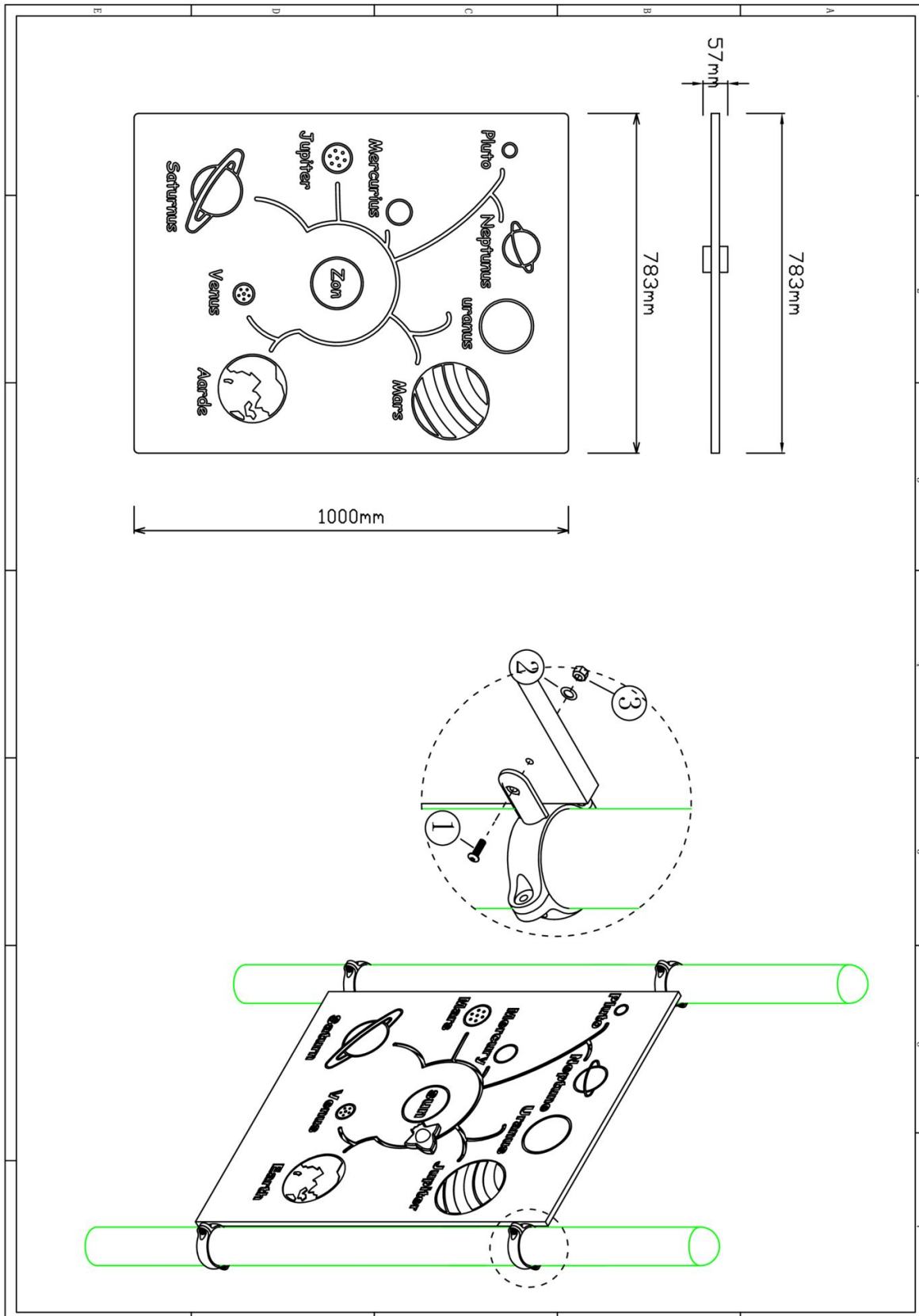

Hoofdafmetingen: 100x78x6cm



PE Planeten paneel

STAP 1 van 1

Omschrijving: Bevestiging tussen het paneel en de staanders

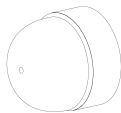
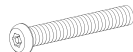
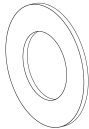
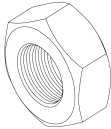
1 st. PE Planeten paneel	4 st. PE-Klem	4 st. Afdekdop M8	4 st. Torx M8X30
			1 
4 st. Ring M8 (middel)	4 st. Lock Moer M8		
2 	3 		

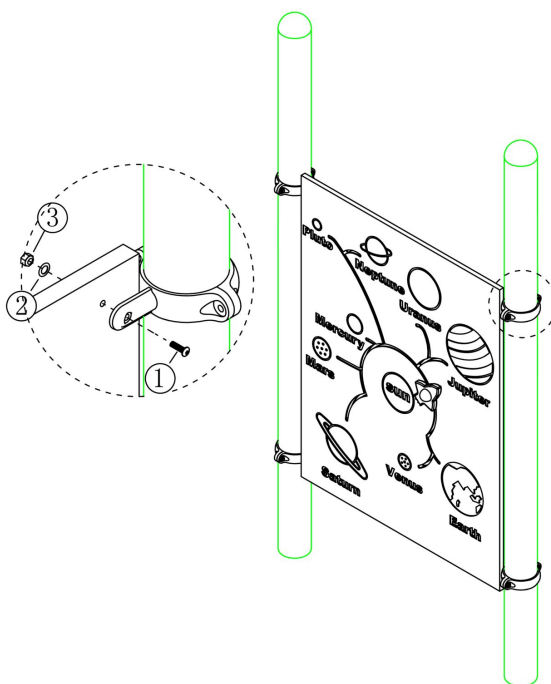

Bevestigings materiaal is per zakje verpakt en bovenstaande afbeelding zit in het zakje



PE Autorace paneel

1 STUK



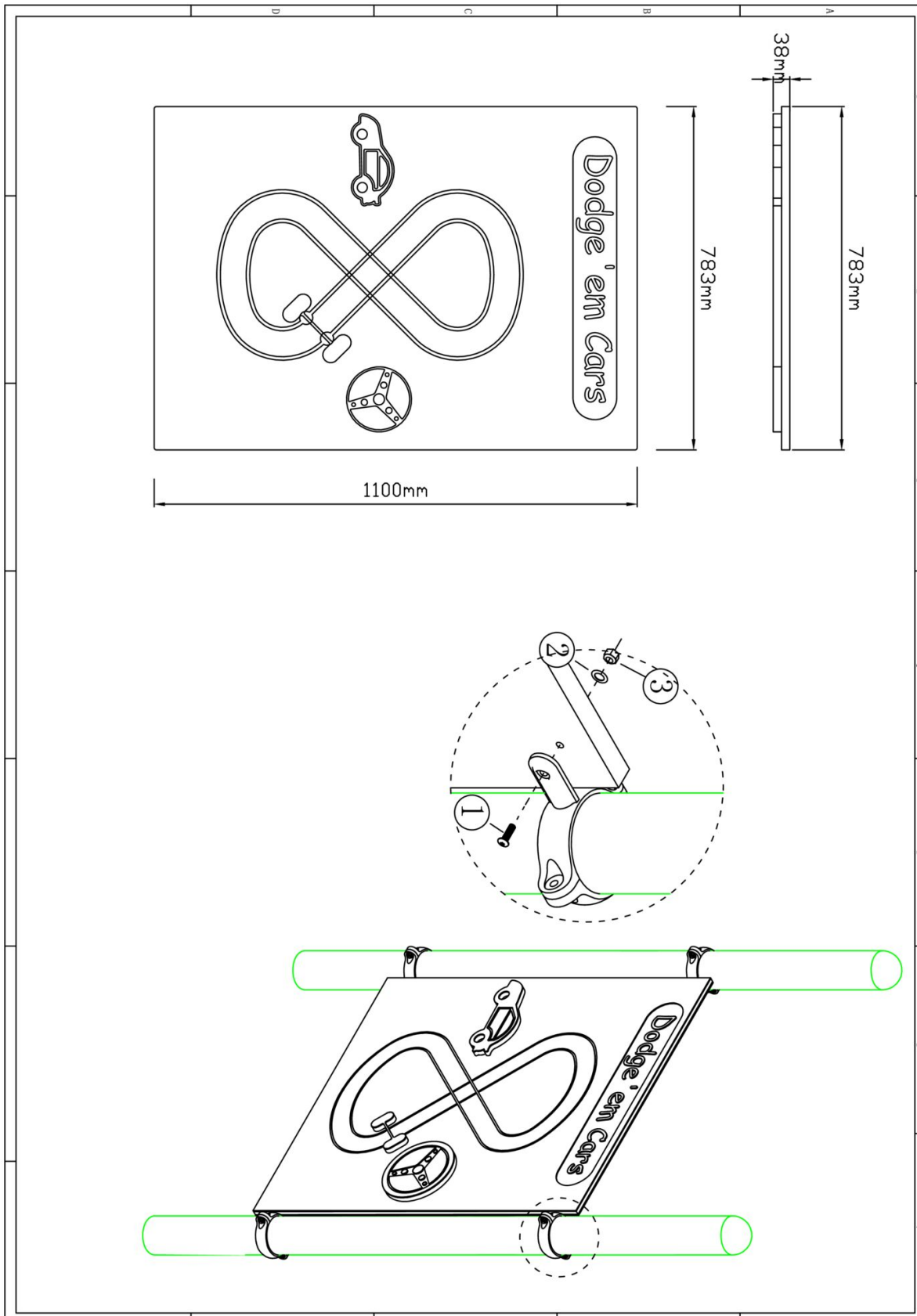

Hoofdafmetingen: 110x78x4cm



PE Autorace paneel

STAP 1 van 1

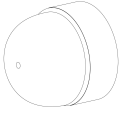
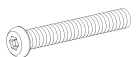
Omschrijving: Bevestiging tussen het paneel en de staanders

1 st. PE Autorace paneel	4 st. PE-Klem	4 st. Afdekdop M8	4 st. Torx M8X30
			 1
4 st. Ring M8 (middel)	4 st. Lock Moer M8		
 2	 3		

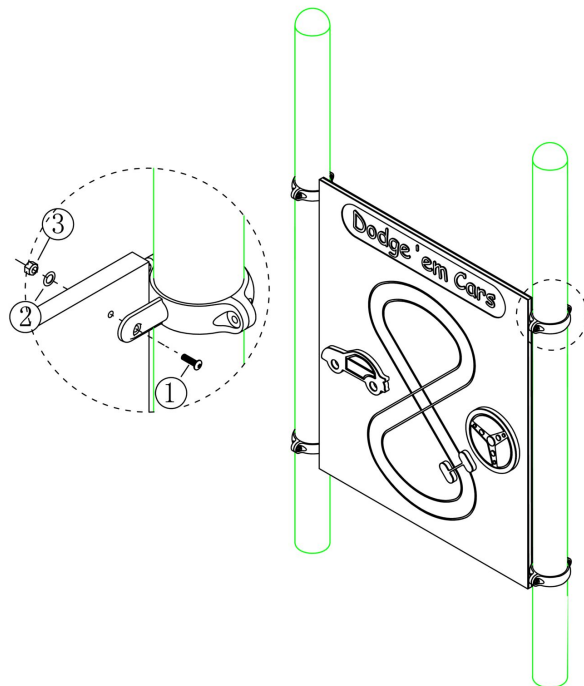

Bevestigings materiaal is per zakje verpakt en bovenstaande afbeelding zit in het zakje

PE Kompaspaneel Piraat

1 STUK

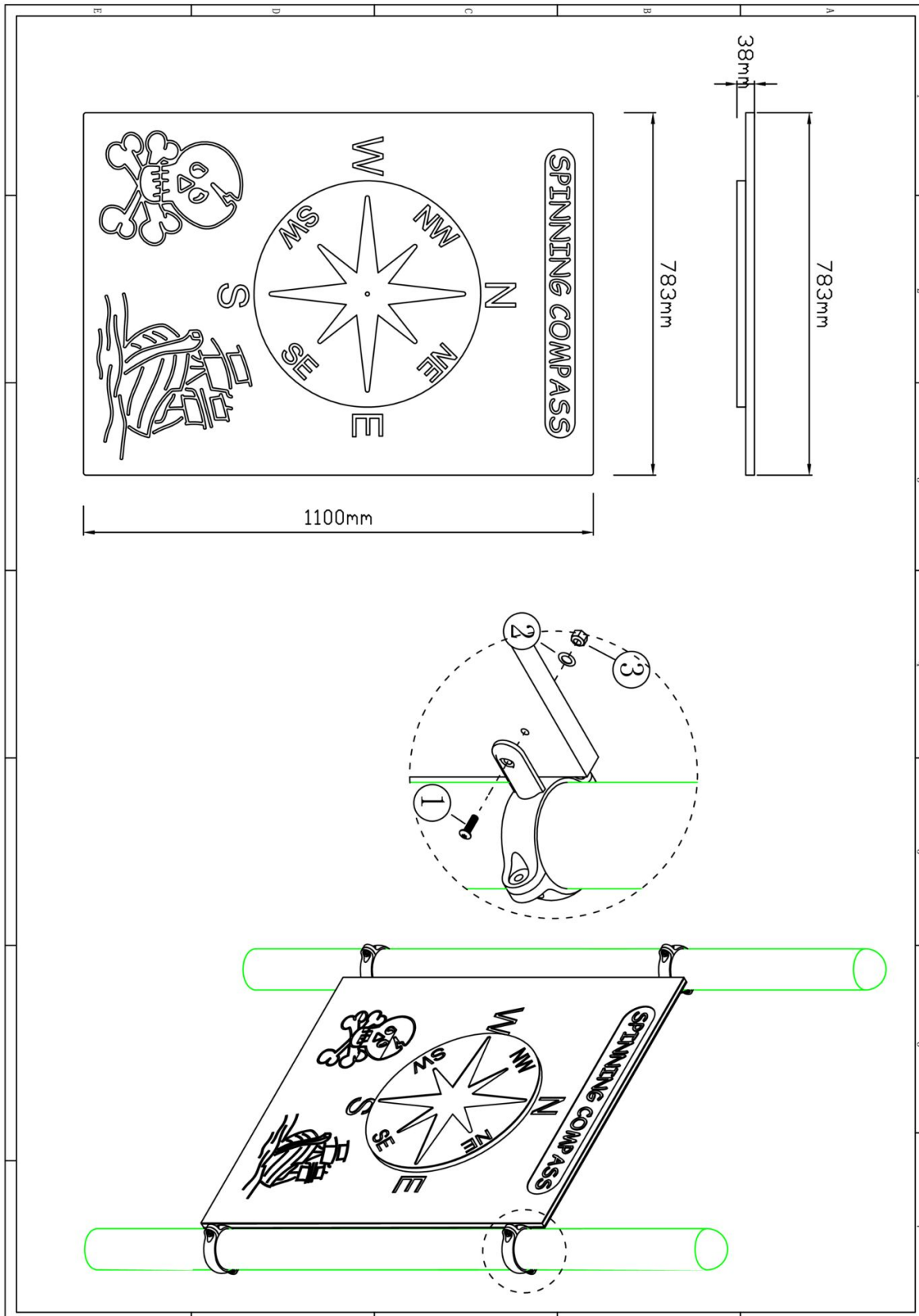

Hoofdafmetingen: 110x78x4cm



PE Kompaspaneel Piraat

STAP 1 van 1

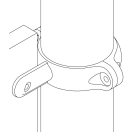
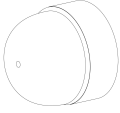
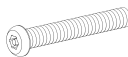
Omschrijving: Bevestiging tussen het paneel en de staanders

1 st. PE Kompaspaneel Piraat	4 st. PE-Klem	4 st. Afdekdop M8	4 st. Torx M8X30
			
4 st. Ring M8 (middel)	4 st. Lock Moer M8		
			

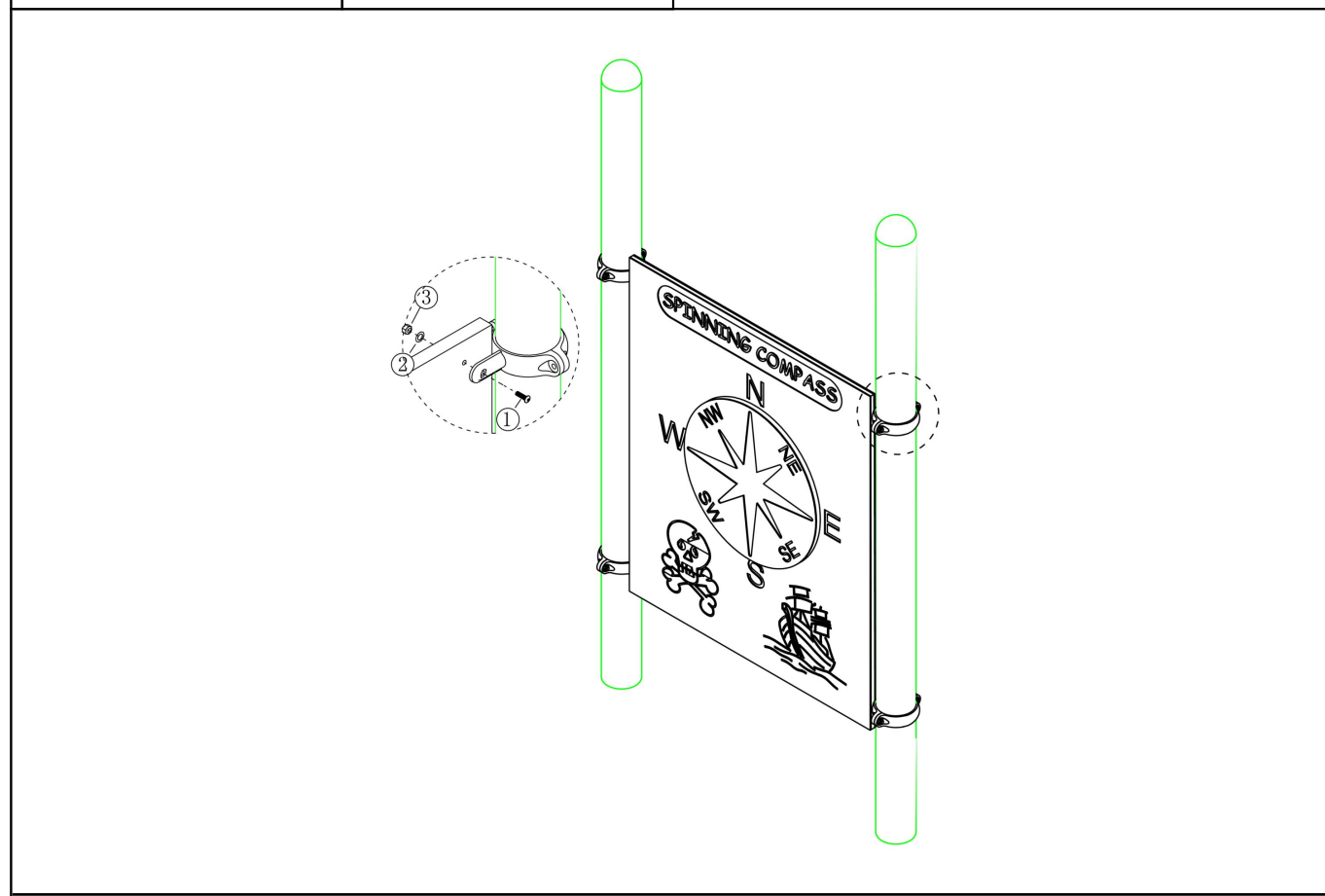

Bevestigings materiaal is per zakje verpakt en bovenstaande afbeelding zit in het zakje

PE Bankje

1 STUK

Hoofdafmetingen: 76x20x2cm

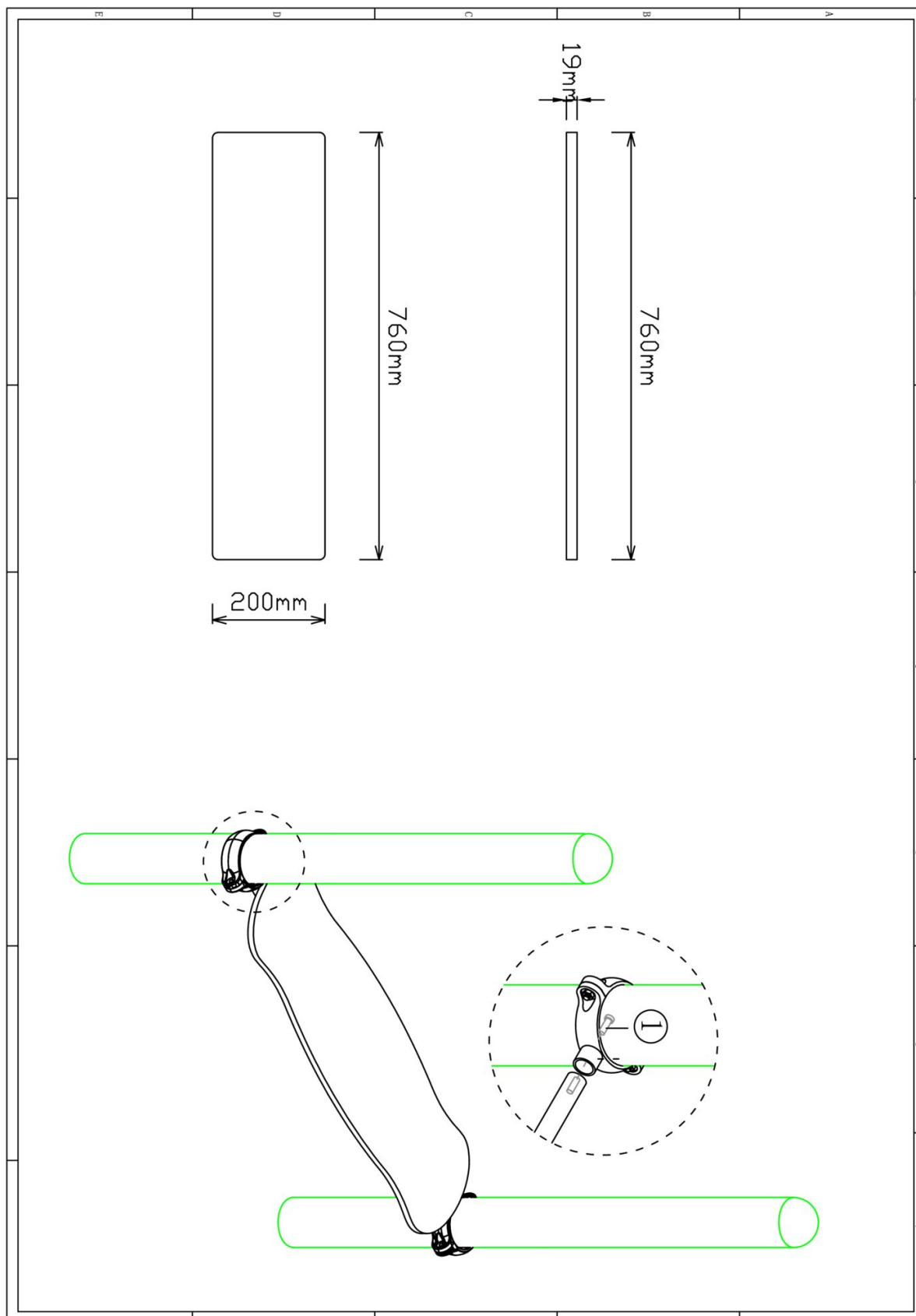

PE Bankje

STAP 1 van 3

Omschrijving: Zelftap bouten aanbrengen aan de binnenkant van de palen

2 st. Kruiskop M3X16
Zelftap

1

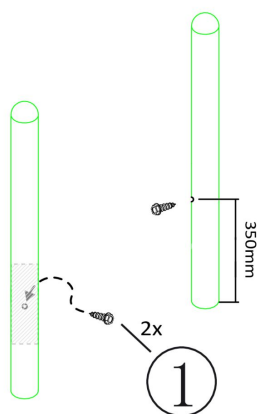

Bevestigings materiaal is per zakje verpakt en bovenstaande afbeelding zit in het zakje

PE Bankje

STAP 2 van 3

Omschrijving: Koppelingsring aan het bankje monteren

1 st. PE Bankje	2 st. PE klem voor stangen	2 st. Torx M8X30
		

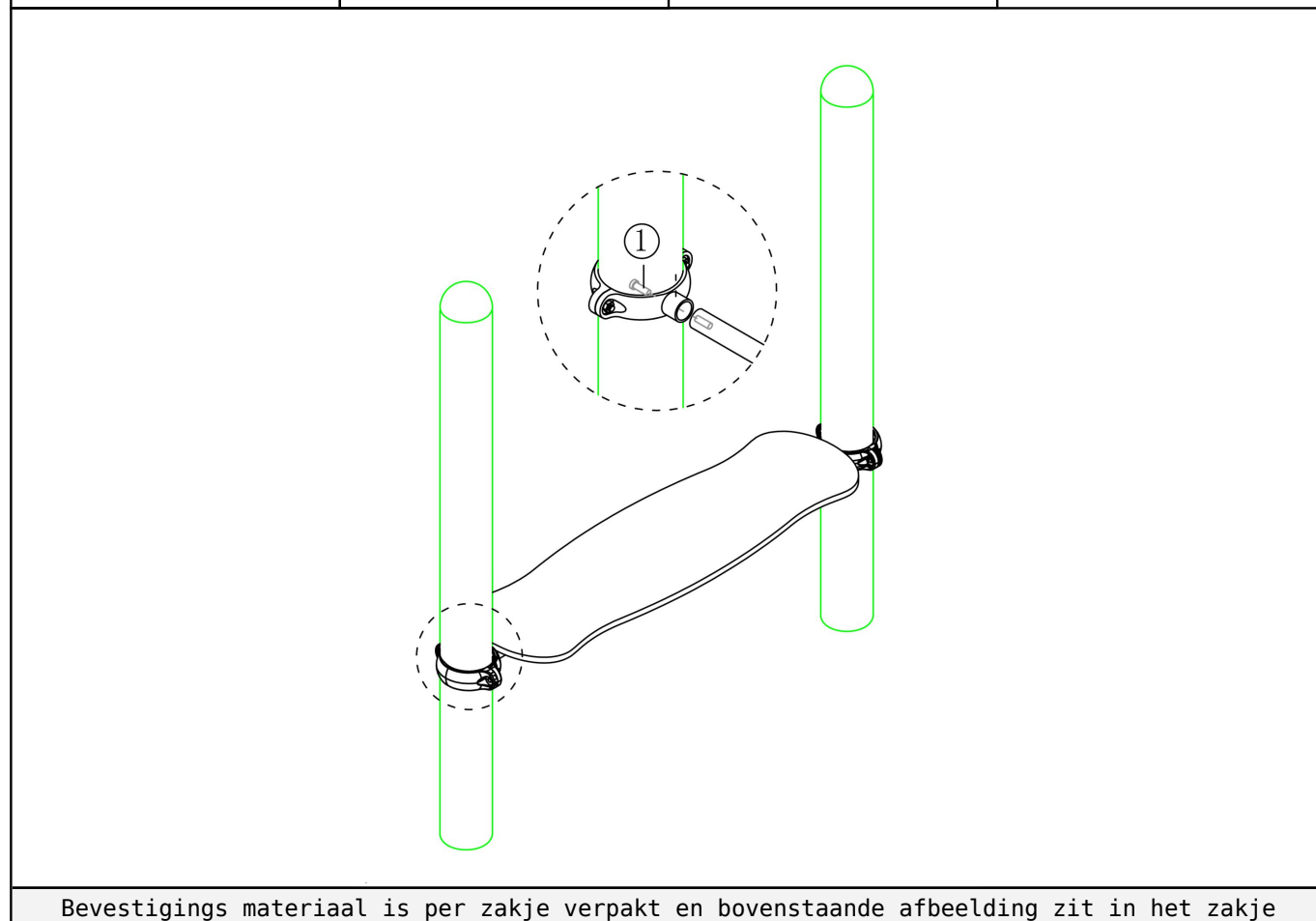

PE Bankje

STAP 3 van 3

Omschrijving: Koppelingsring met bank over de schroef schuiven en vastzetten zodat de schroef niet meer zichtbaar is en de ring door de schroef niet kan zakken op de paal

