



TnT speeltoestellen

Montagehandleiding PE-KS001



Toestel typenummer	PE-KS001
Datum montagehandleiding	26/09/2022
Versienummer montagehandleiding	2.2

Beste klant van TnT Speeltoestellen,

Wij danken u voor het aanschaffen en installeren van een speeltoestel van TnT Speeltoestellen. Wij waarderen het vertrouwen dat u in ons bedrijf heeft geplaatst en streven ernaar om uw vertrouwen meer dan waar te maken!

Dit is uw TnT speeltoestellen montagehandleiding.

Wij hebben deze handleiding specifiek voor het product ontworpen, waarop eveneens de toe te passen onderdelen zijn genoemd.

Ook vindt u het grondplan met de benodigde valruimte volgens norm NEN-EN1176-1 : 2017.

Bewaart u dit document bij uw logboek. Nogmaals willen wij u bedanken voor de aankoop van dit speeltoestel. Wij zien uit naar uw volgende speelproject.

Met vriendelijke groet, TnT Speeltoestellen



Inhoudsopgave

Aanzichten 3D	3
Onderdelenlijst	4
Veiligheidsruimtes	5
Aanzichten 2D	6
Plattegrond palenplan	7
Onderdeel handleidingen	8
<i>frame PE-KS001</i>	9
<i>Stang 1 frame</i>	10
<i>Stang 2 frame</i>	11
<i>Tafel paneel PE-KS001</i>	13
<i>Dak paneel PE-KS001</i>	15
<i>Boom Paneel PE-KS001</i>	17
<i>Struik paneel PE-KS001</i>	19

Aanzichten 3D





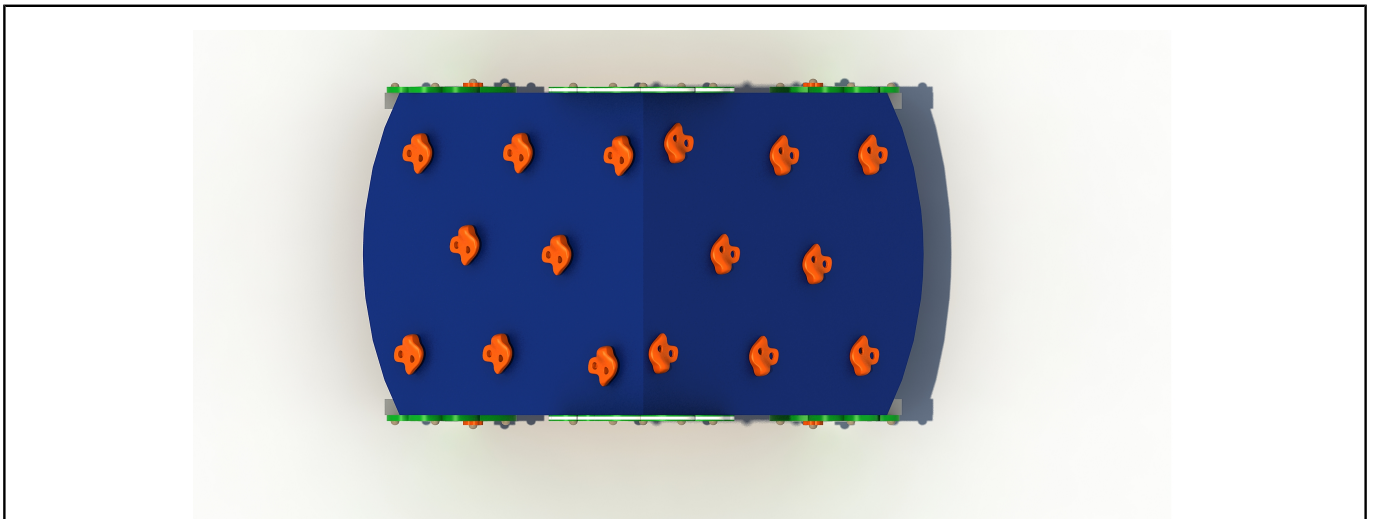

Aanzicht 1

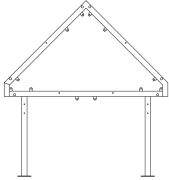
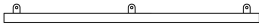

Aanzicht 3

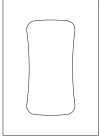
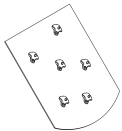
Onderdelenlijst

<p>2 st. frame PE-KS001</p>	<p>8 st. Stang 1 frame</p>	<p>2 st. Stang 2 frame</p>	<p>1 st. Tafel paneel PE-KS001</p>
<p>183x15x196cm</p>	<p>112x7x4cm</p>	<p>112x4x4cm</p>	<p>120x85x1.5cm</p>
			
<p>2 st. Dak paneel PE-KS001</p>	<p>2 st. Boom Paneel PE-KS001</p>	<p>4 st. Struik paneel PE-KS001</p>	
<p>120x151x1.5cm</p>	<p>126x69x1.9cm</p>	<p>57x49x1.9cm</p>	
			

Veiligheidsruimtes

Geachte klant,

Zorg er altijd voor dat alle veiligheids ruimtes zoals aangegeven in ieder geval gehaald worden, dit zijn de minimale vereiste ruimtes voor een veilig gebruik van het speeltoestel.

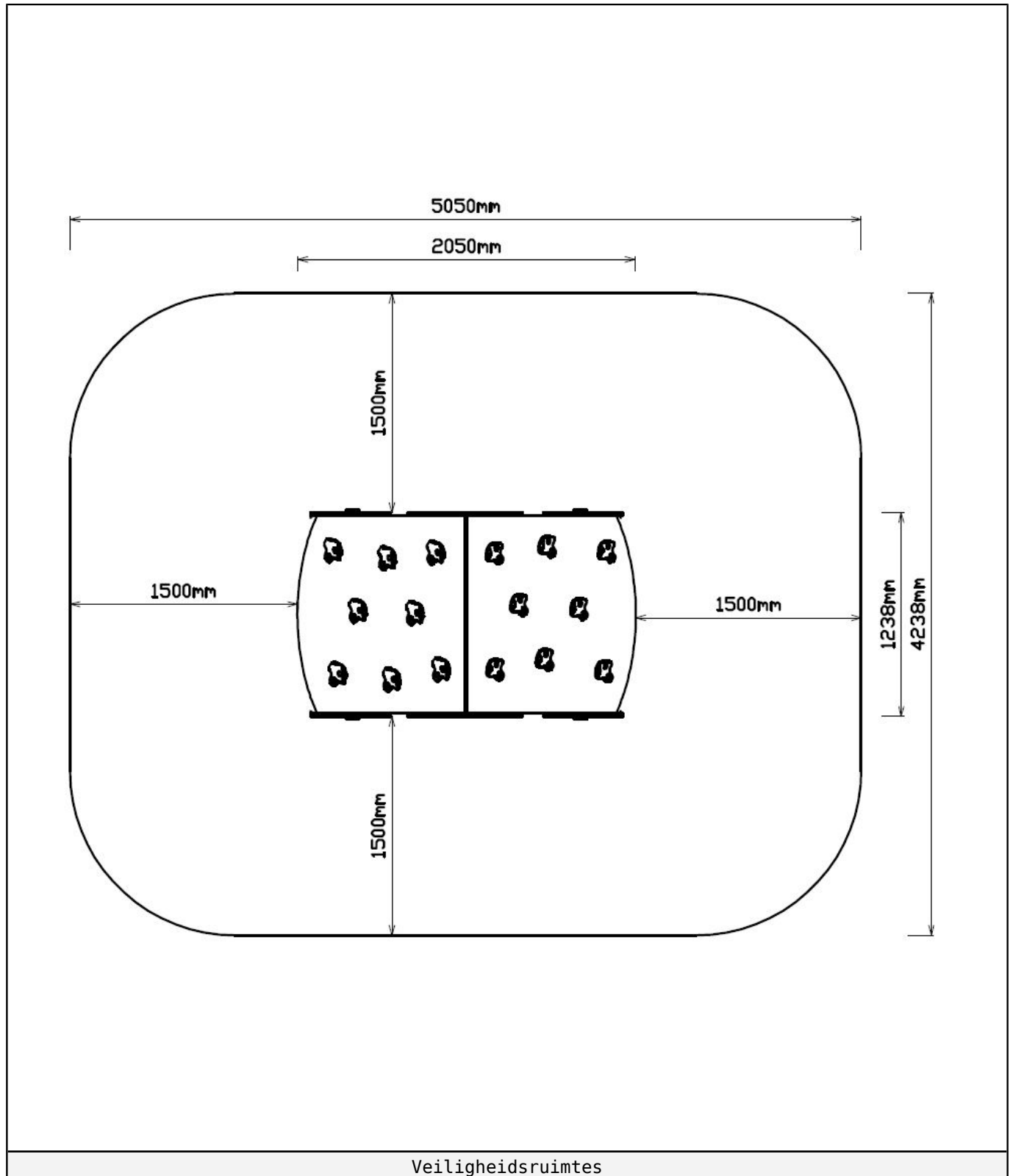

Aanzichten 2D

Hier vindt u de beschikbare aanzichtstekeningen.

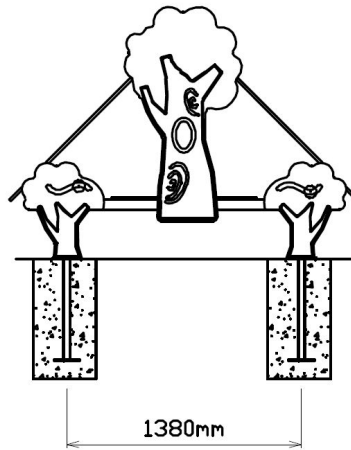

Vooraanzicht

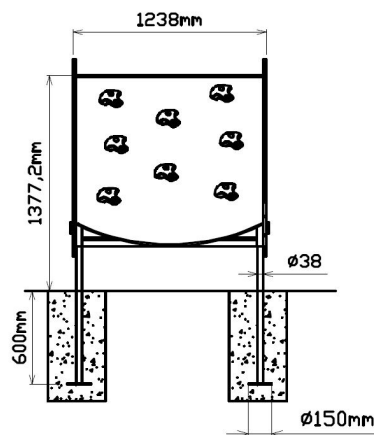

Zijaanzicht

Plattegrond palenplan

U kunt van deze tekening niet afmeten!

Voor de betonfundatie heeft u 50 kg snelbeton per staander nodig.

Houdt u er rekening mee dat de betonfundatie minimaal 400mm onder het maaiveld blijft, zoals op de tekening afgebeeld.

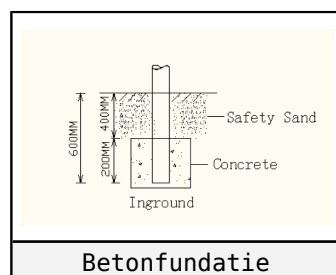
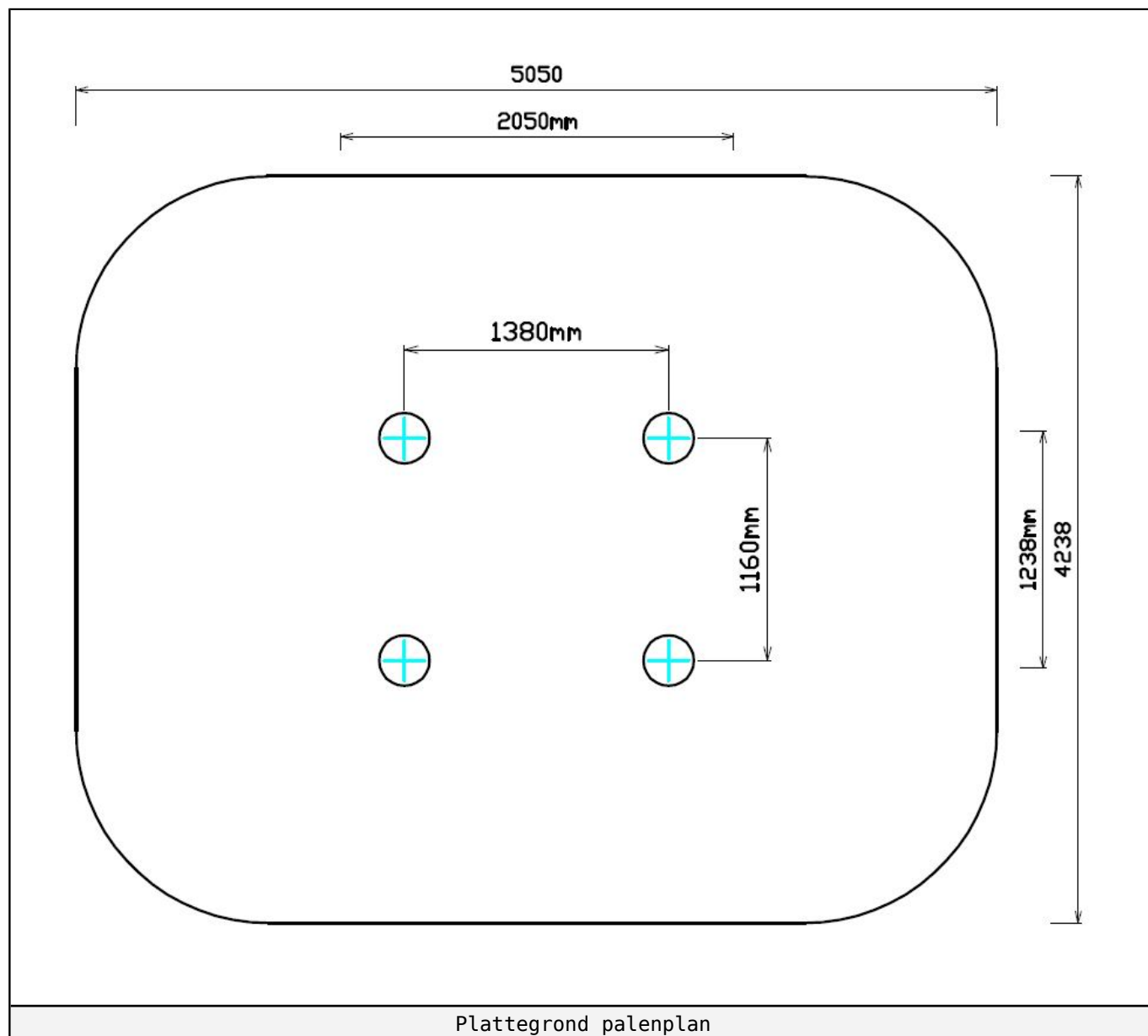

Onderdeel handleidingen

Op de volgende pagina's van dit document vindt u alle individuele onderdelen met bijhorende technische tekeningen en eventuele montage instructies.

frame PE-KS001

2 STUKS

Hoofdafmetingen: 183x15x196cm

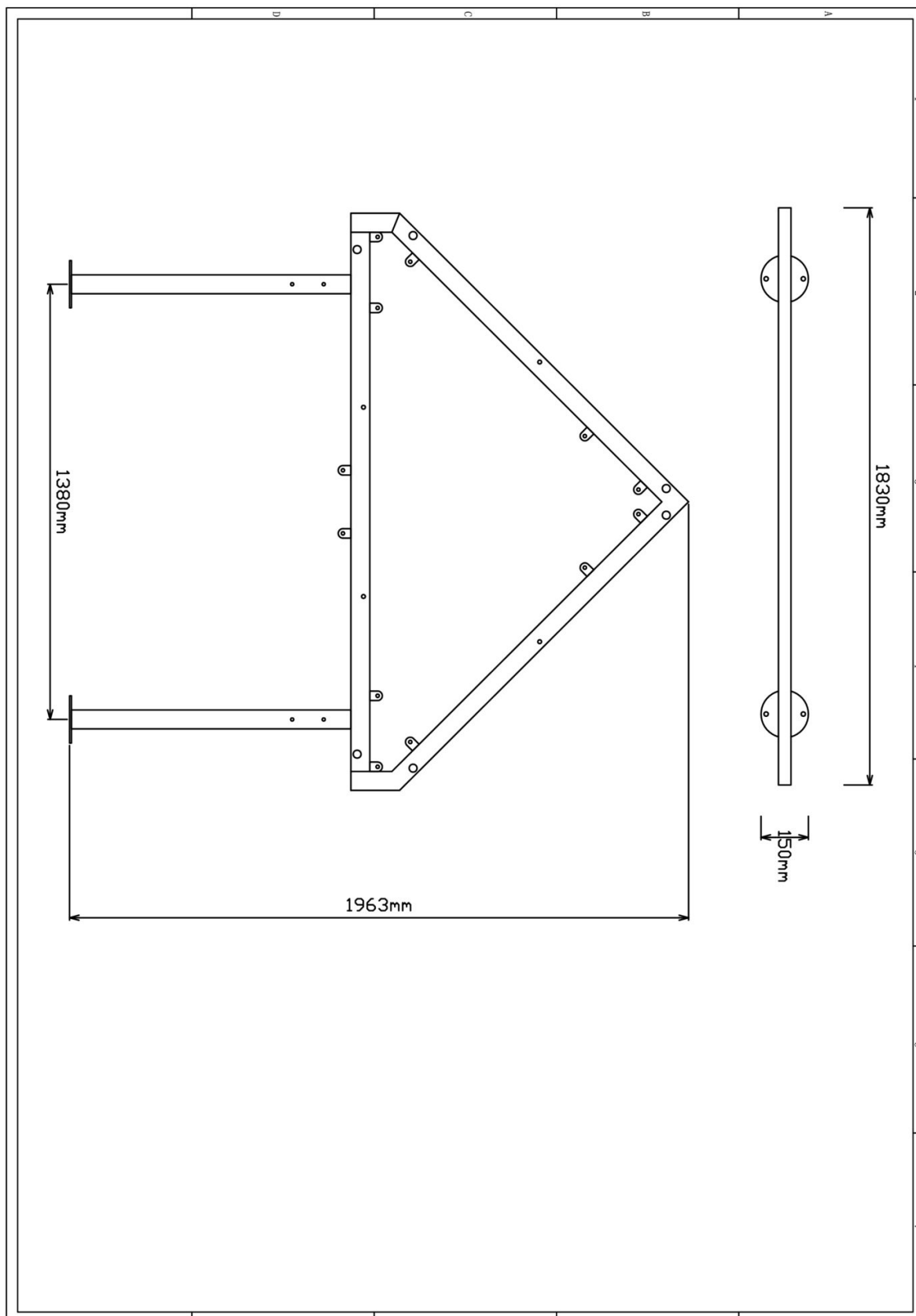



Stang 1 frame

8 STUKS

Hoofdafmetingen: 112x7x4cm

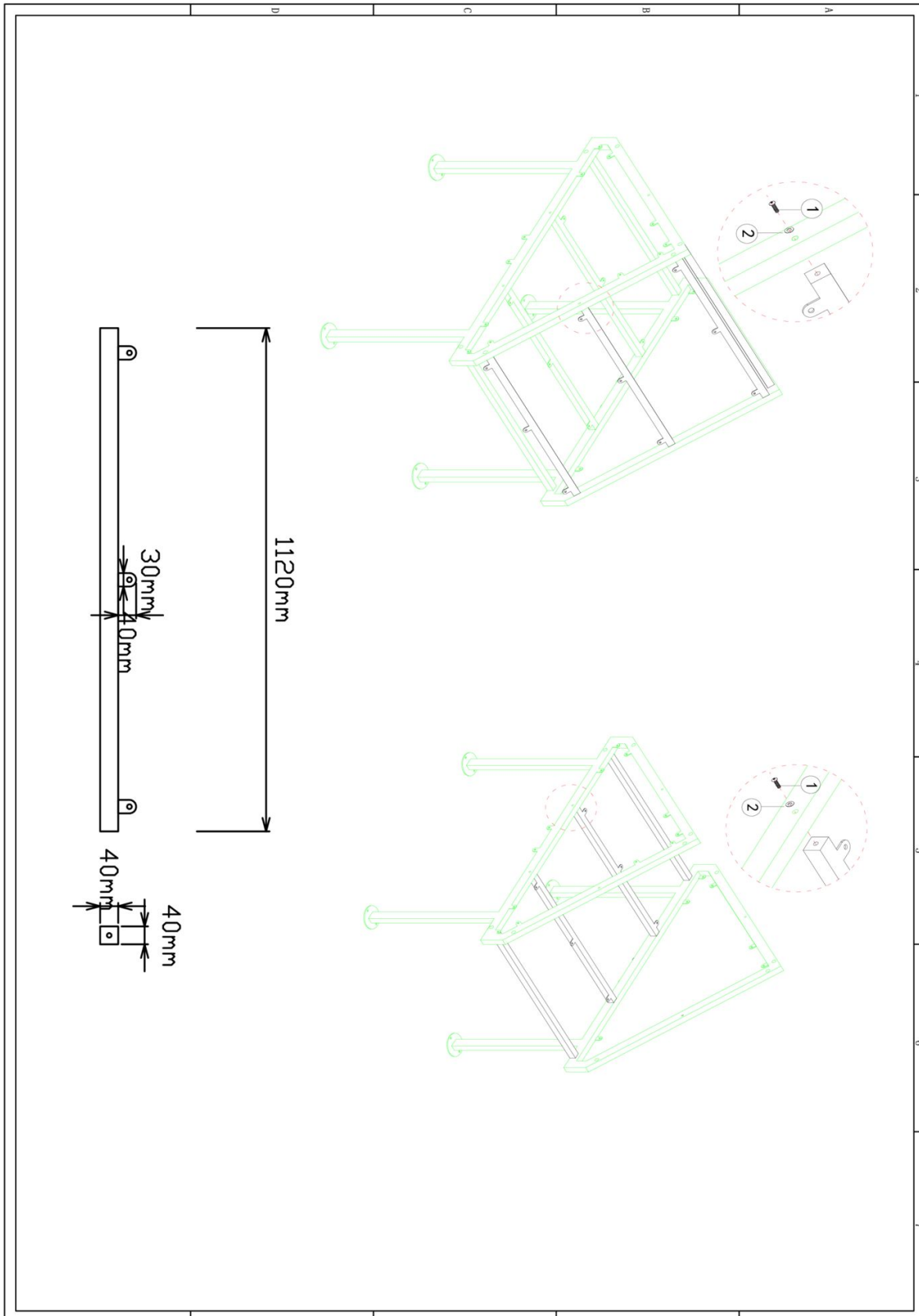



Stang 2 frame

2 STUKS



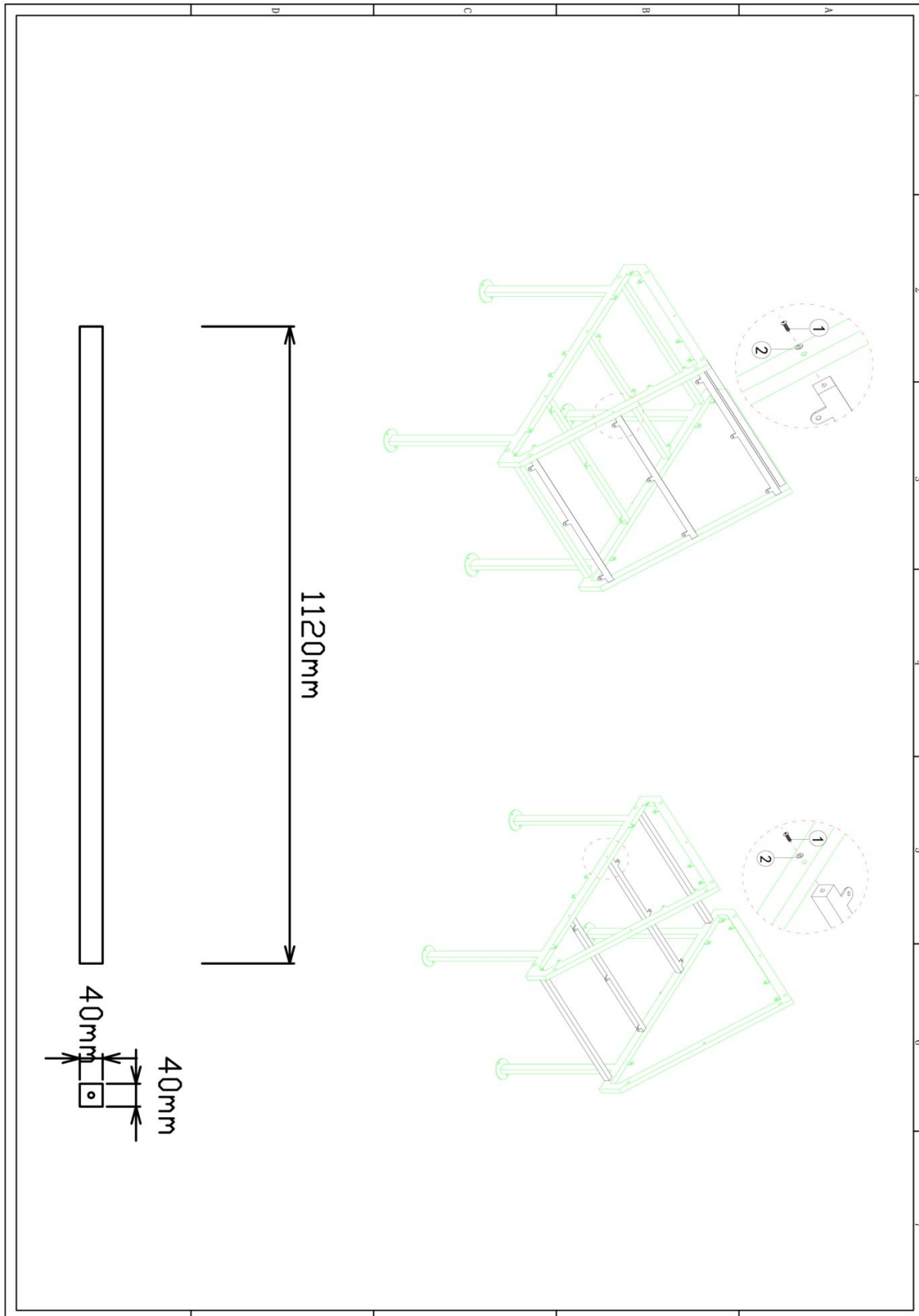

Hoofdafmetingen: 112x4x4cm

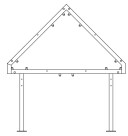

Stang 2 frame

STAP 1 van 1

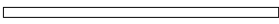
Omschrijving: Bevestiging tussen stangen (1 en 2) aan het frame

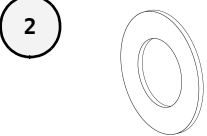
2 st. frame PE-KS001	8 st. Stang 1 frame	2 st. Stang 2 frame	20 st. Torx M10X80
			
20 st. Ring M10 (middel)			
			

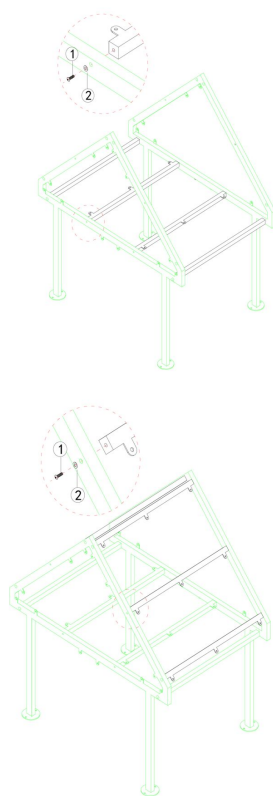

Bevestigings materiaal is per zakje verpakt en bovenstaande afbeelding zit in het zakje



Tafel paneel PE-KS001

1 STUK

Hoofdafmetingen: 120x85x1.5cm

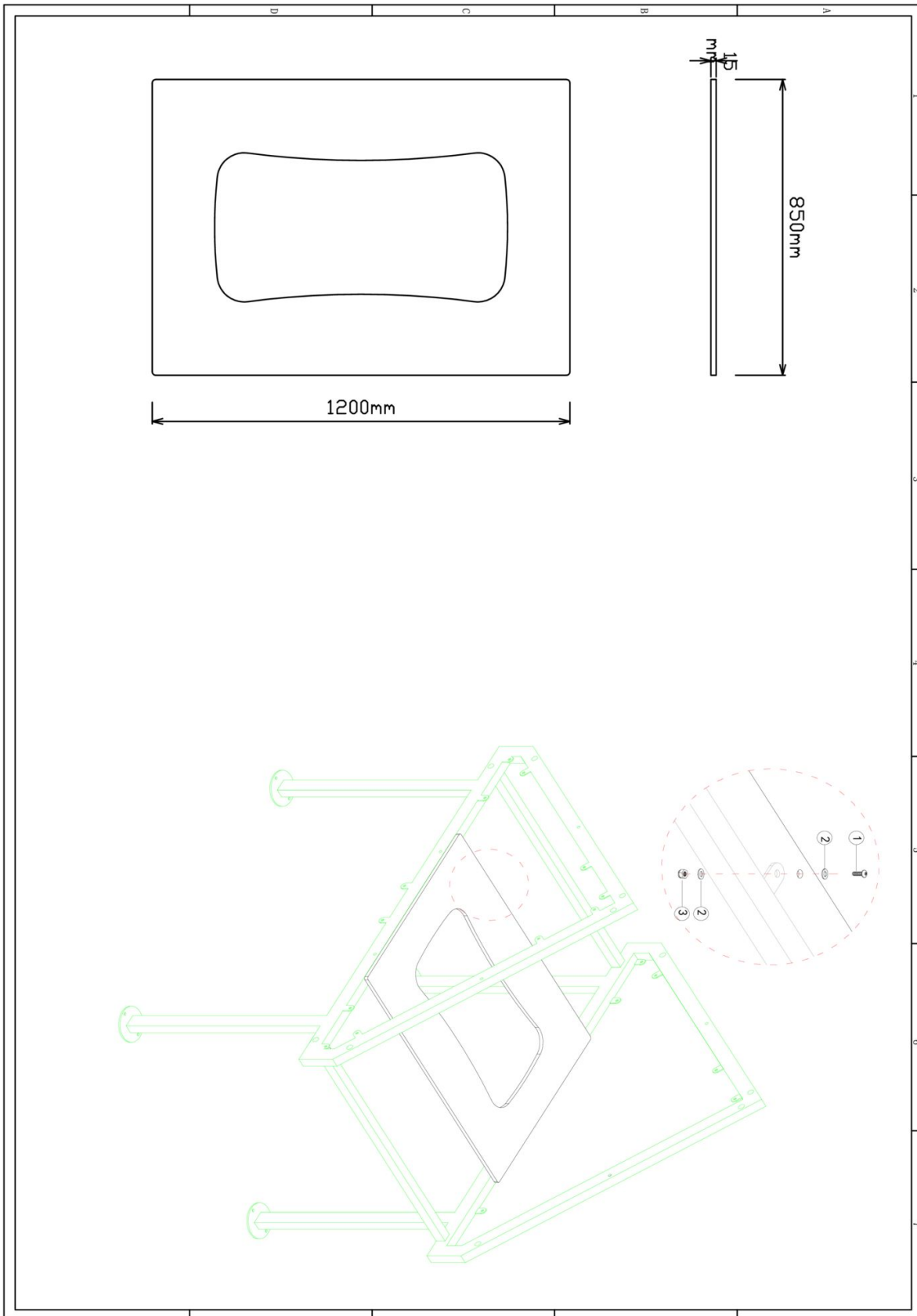

Tafel paneel PE-KS001

STAP 1 van 1

Omschrijving: Bevestiging tussen tafelpaneel en het frame

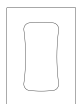
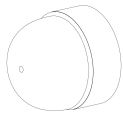
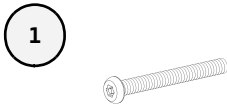
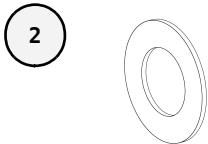
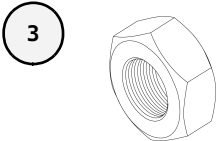
1 st. Tafel paneel PE-KS001	6 st. Afdekdop M8	6 st. Torx M8X40	12 st. Ring M8 (middel)
			
6 st. Lock Moer M8			
			

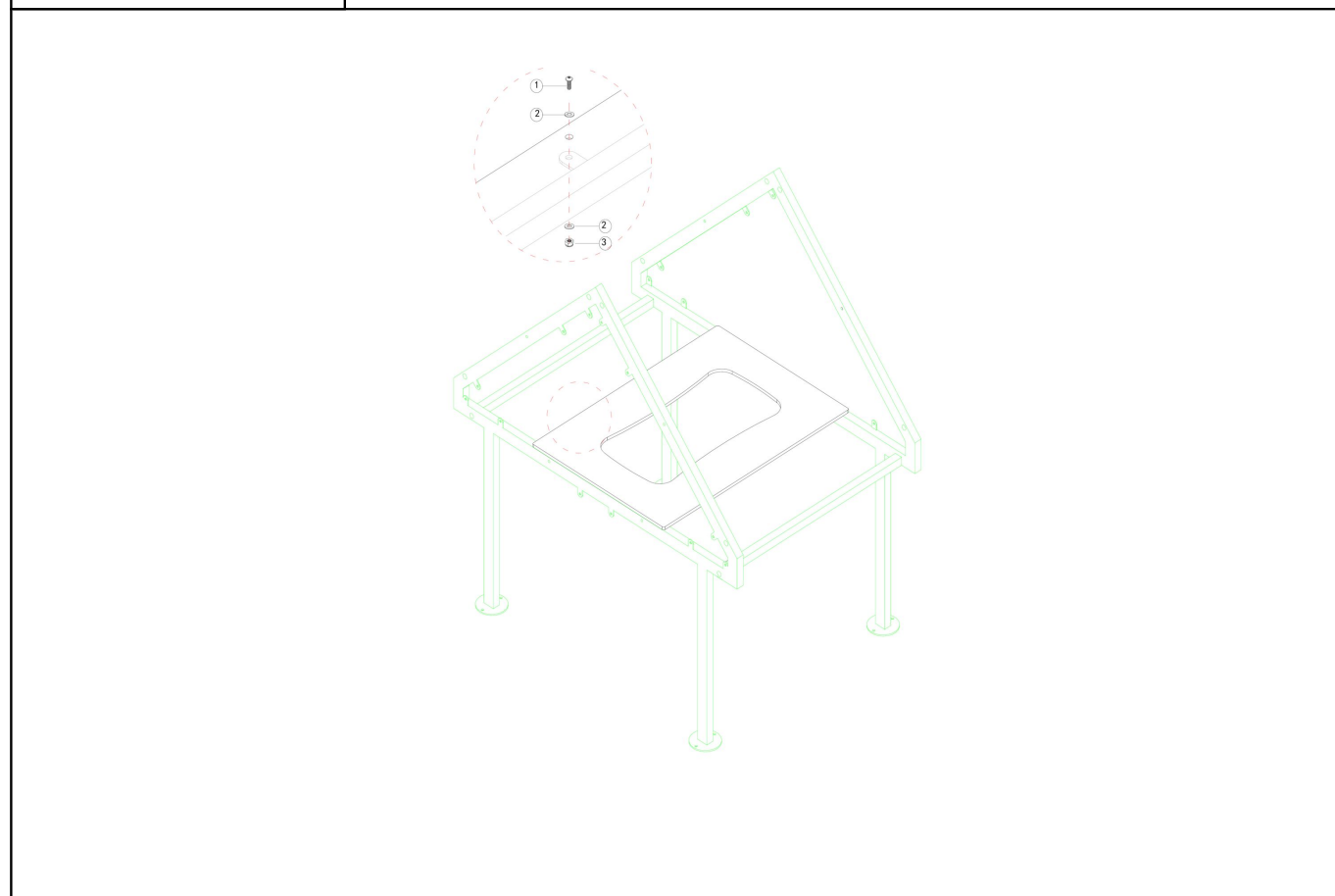

Bevestigings materiaal is per zakje verpakt en bovenstaande afbeelding zit in het zakje



Dak paneel PE-KS001

2 STUKS

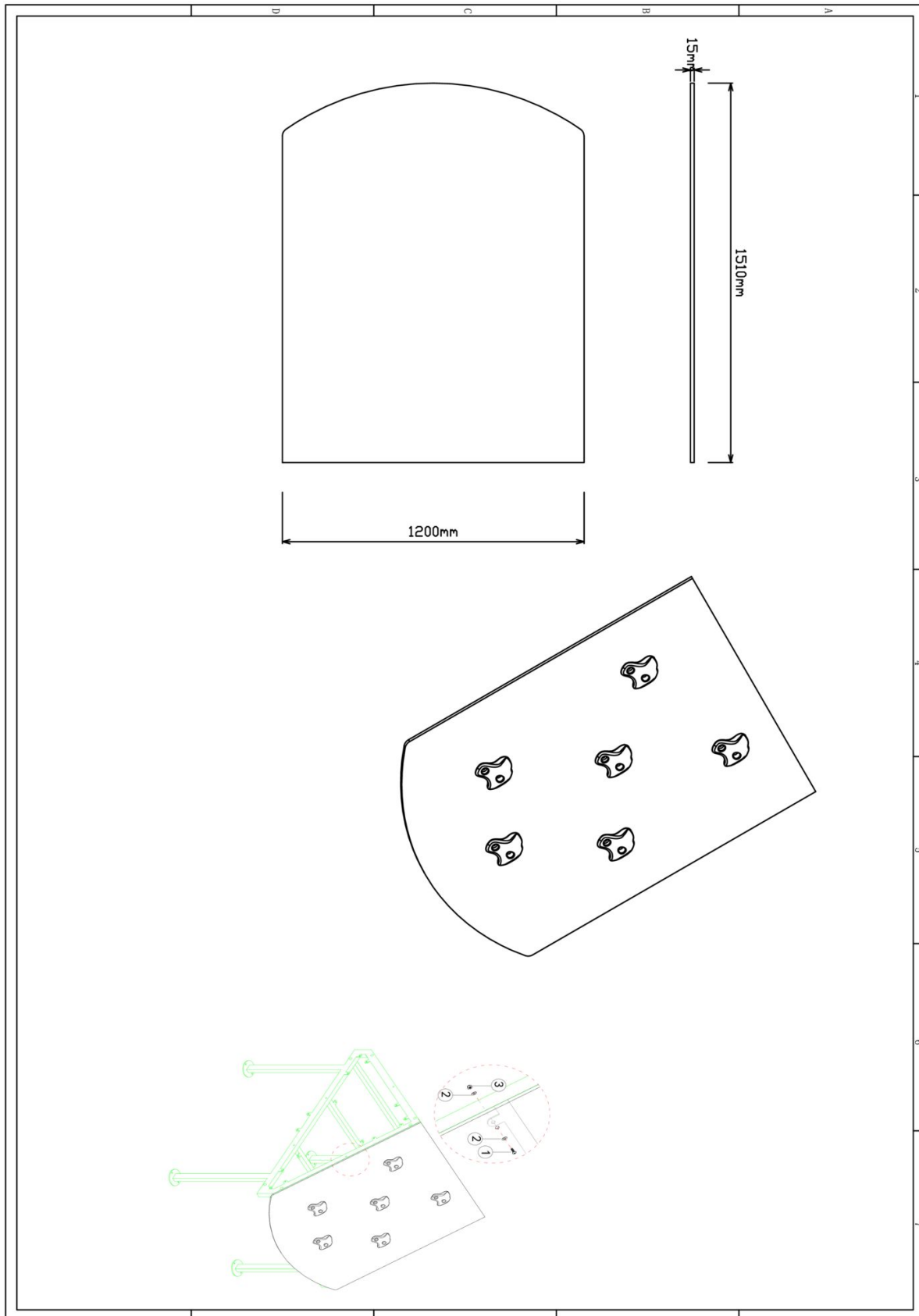

Hoofdafmetingen: 120x151x1.5cm



Dak paneel PE-KS001

STAP 1 van 1

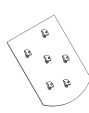
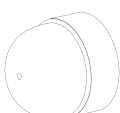
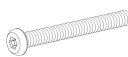
Omschrijving: Bevestiging tussen dakpaneel en het frame

2 st. Dak paneel PE-KS001	18 st. Afdekdop M8	18 st. Torx M8X40	36 st. Ring M8 (middel)
			
18 st. Lock Moer M8			
			

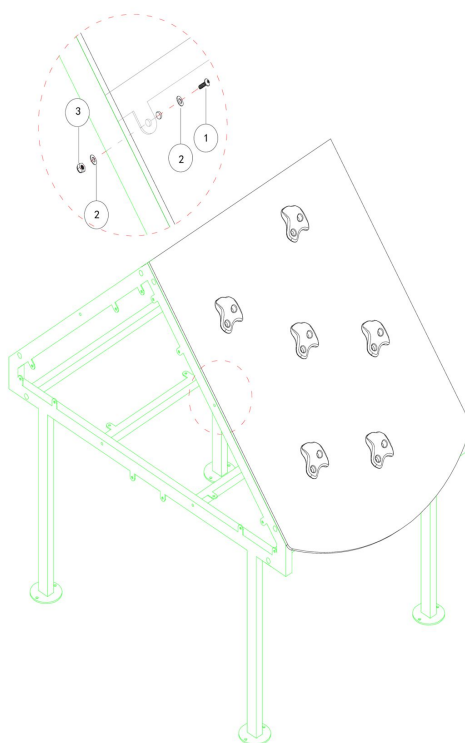

Bevestigings materiaal is per zakje verpakt en bovenstaande afbeelding zit in het zakje

Boom Paneel PE-KS001

2 STUKS

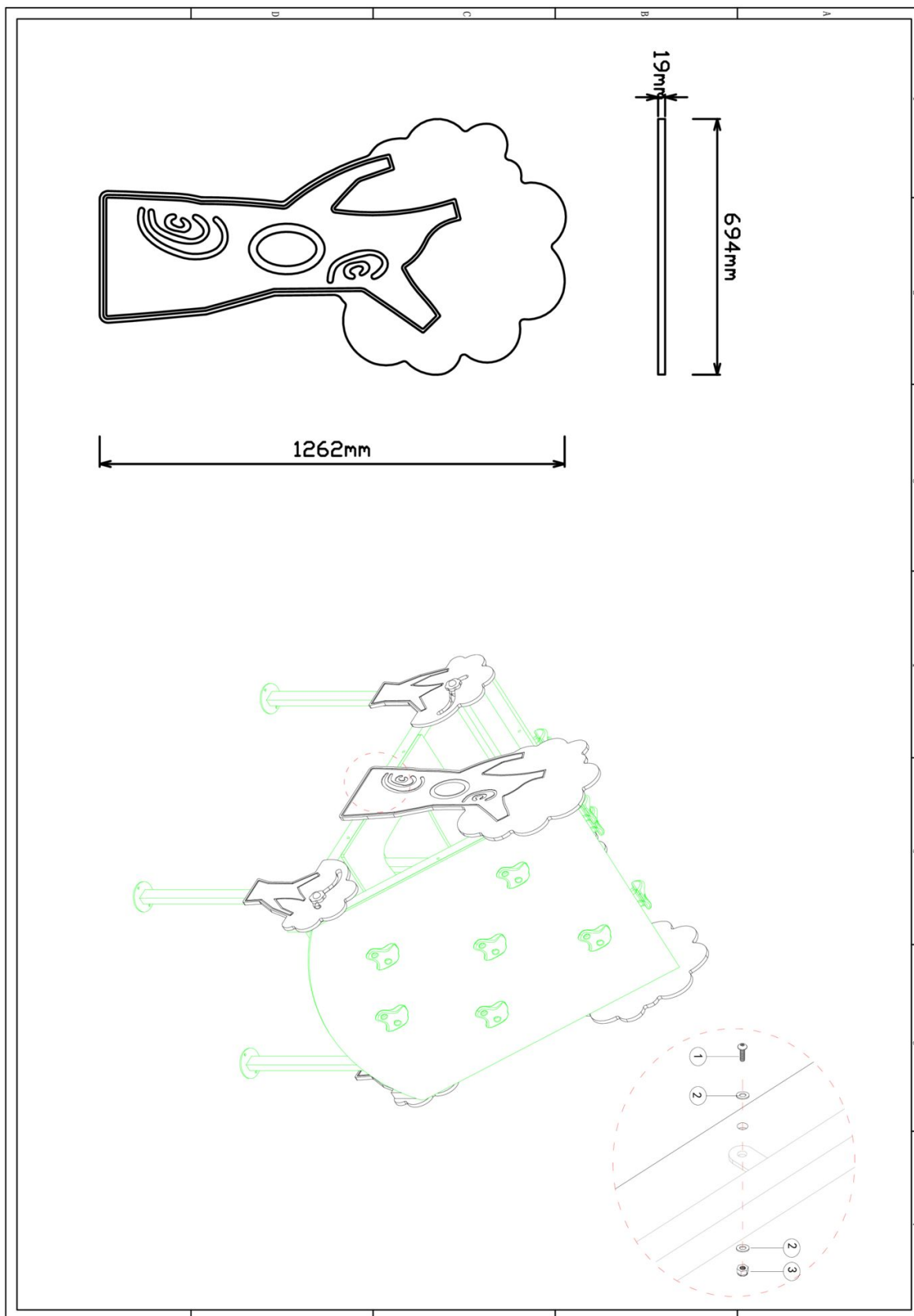

Hoofdafmetingen: 126x69x1.9cm



Boom Paneel PE-KS001

STAP 1 van 1

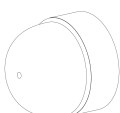
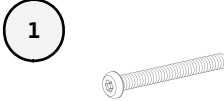
Omschrijving: Bevestiging tussen het boom paneel en het frame

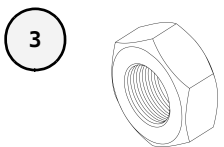
2 st. Boom Paneel PE-KS001	12 st. Afdekdop M8	12 st. Torx M8X40	24 st. Ring M8 (middel)
			
12 st. Lock Moer M8			
			

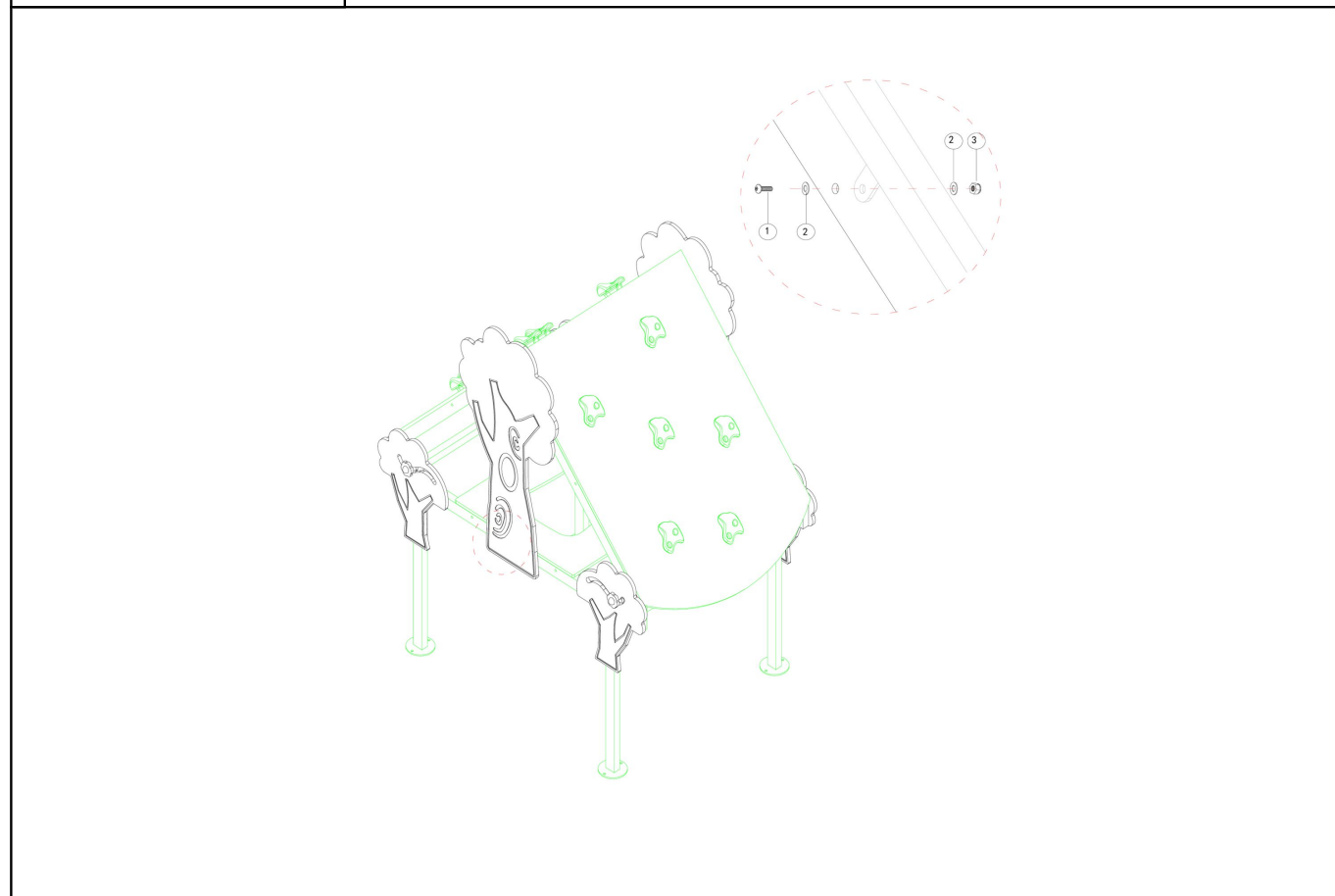

Bevestigings materiaal is per zakje verpakt en bovenstaande afbeelding zit in het zakje

Struik paneel PE-KS001

4 STUKS

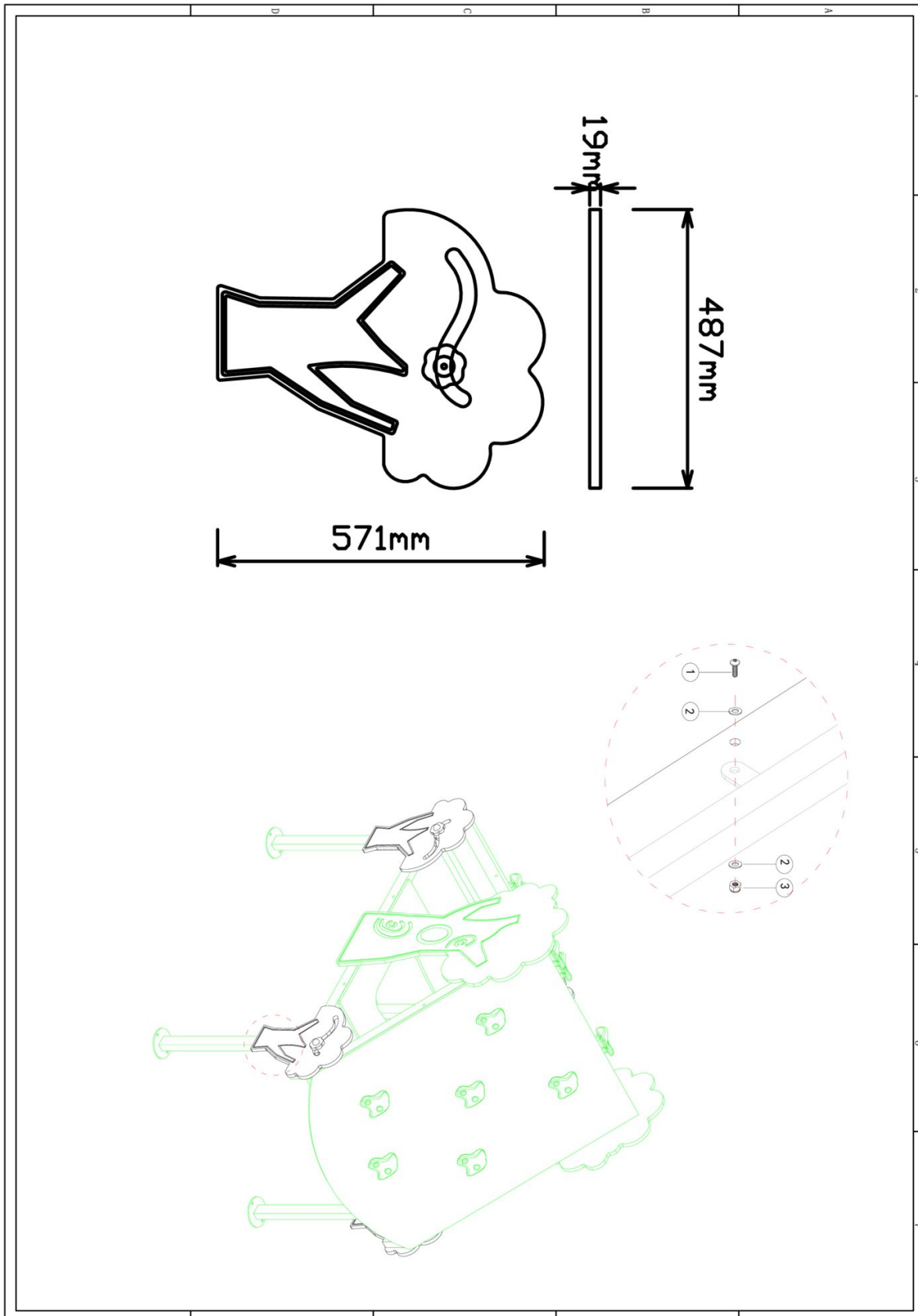

Hoofdafmetingen: 57x49x1.9cm



Struik paneel PE-KS001

STAP 1 van 1

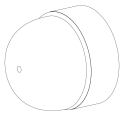
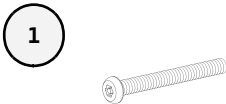
Omschrijving: Bevestiging tussen struik paneel en het frame

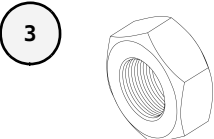
4 st. Struik paneel PE-KS001	20 st. Afdekdop M8	20 st. Torx M8X40	40 st. Ring M8 (middel)
			
20 st. Lock Moer M8			
			

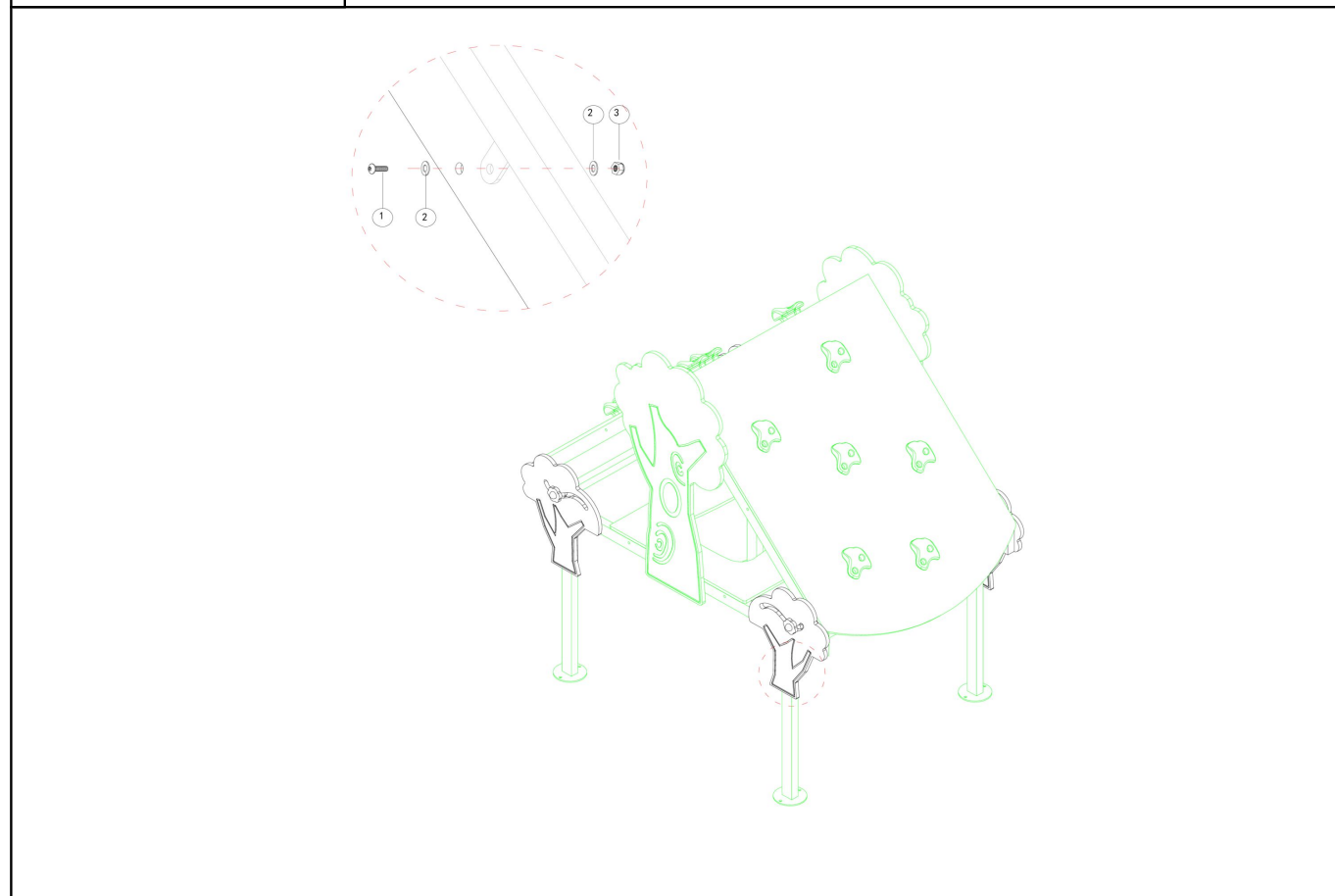

Bevestigings materiaal is per zakje verpakt en bovenstaande afbeelding zit in het zakje