



# TnT speeltoestellen

## Montagehandleiding B-061



---

Toestel typenummer	<b>B-061</b>
Datum montagehandleiding	<b>12/10/2018</b>
Versienummer montagehandleiding	<b>2.2</b>

---

Beste klant van TnT Speeltoestellen,

Wij danken u voor het aanschaffen en installeren van een speeltoestel van TnT Speeltoestellen. Wij waarderen het vertrouwen dat u in ons bedrijf heeft geplaatst en streven ernaar om uw vertrouwen meer dan waar te maken!

Dit is uw TnT speeltoestellen montagehandleiding.

Wij hebben deze handleiding specifiek voor het product ontworpen, waarop eveneens de toe te passen onderdelen zijn genoemd.

Ook vindt u het grondplan met de benodigde valruimte volgens norm NEN-EN1176-1 : 2017.

Bewaart u dit document bij uw logboek. Nogmaals willen wij u bedanken voor de aankoop van dit speeltoestel. Wij zien uit naar uw volgende speelproject.

Met vriendelijke groet, TnT Speeltoestellen



## Inhoudsopgave

Aanzichten 3D .....	3
Onderdelenlijst .....	4
Veiligheidsruimtes .....	5
Aanzichten 2D .....	6
Plattegrond palenplan .....	7
Onderdeel handleidingen .....	8
<i>Staander B-061 links</i> .....	9
<i>Staander B-061 rechts</i> .....	11
<i>Balk voor B-061</i> .....	13
<i>Brugleuning B-061</i> .....	15
<i>Brug tredes B-061</i> .....	17

## Aanzichten 3D





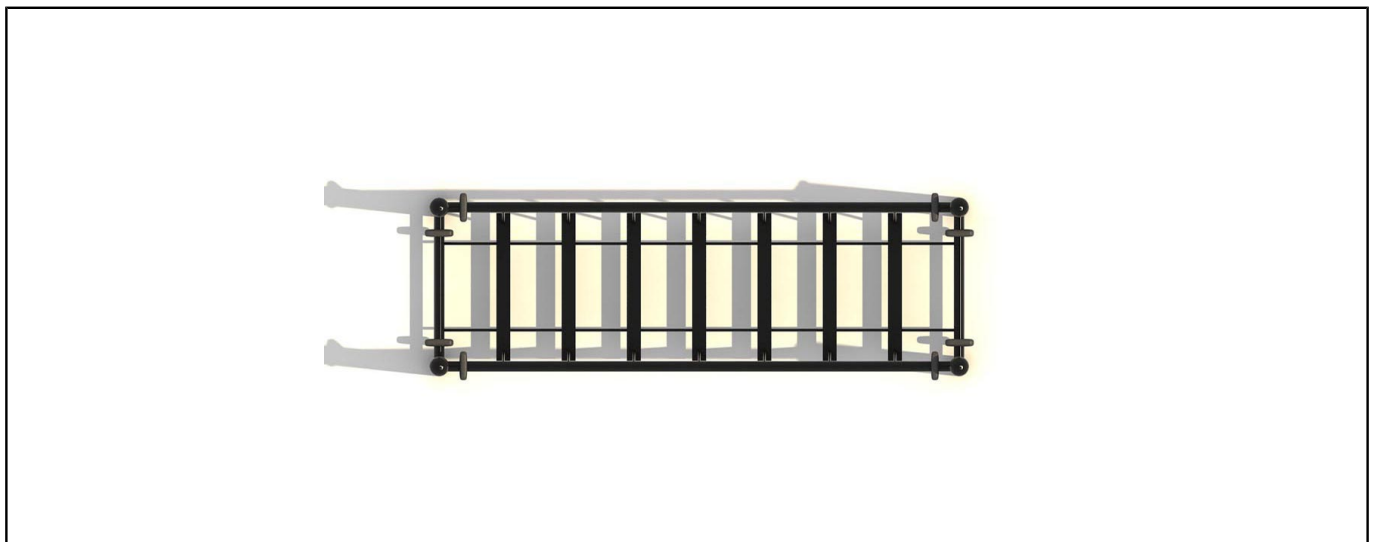

Aanzicht 1

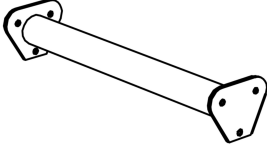

Aanzicht 2

## Onderdelenlijst

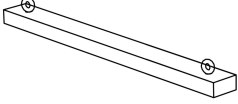
<p><b>2 st. Staander B-061 links</b></p>	<p><b>2 st. Staander B-061 rechts</b></p>	<p><b>2 st. Balk voor B-061</b></p>	<p><b>2 st. Brugleuning B-061</b></p>
<p>180x11,5cm</p>	<p>180x11,5cm</p>	<p>67x6cm</p>	<p>272x6cm</p>
			
<p><b>7 st. Brug tredes B-061</b></p>			
<p>85x8x4cm</p>			
			

## Veiligheidsruimtes

Geachte klant,

Zorg er altijd voor dat alle veiligheids ruimtes zoals aangegeven in ieder geval gehaald worden, dit zijn de minimale vereiste ruimtes voor een veilig gebruik van het speeltoestel.

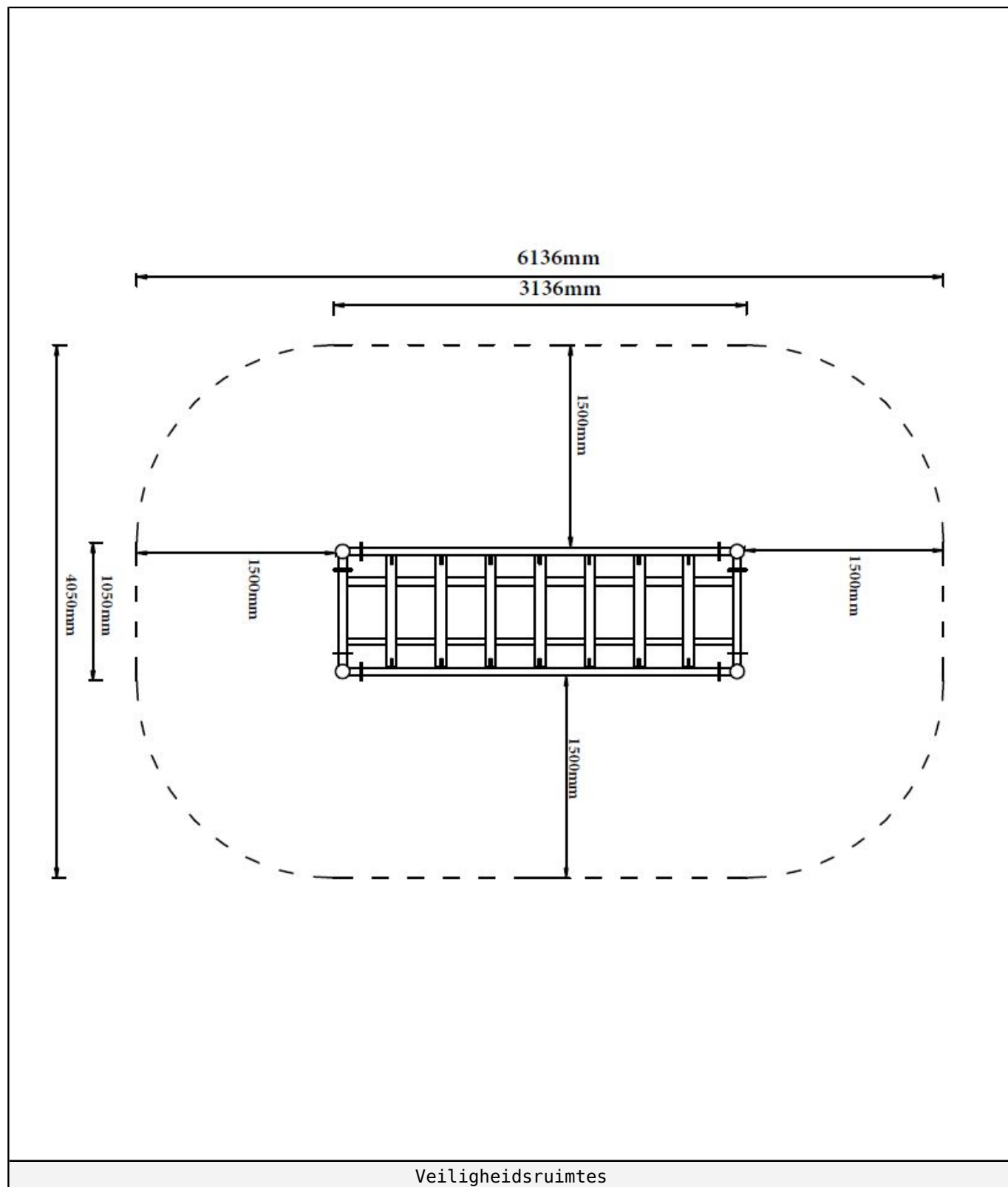

## Aanzichten 2D

Hier vindt u de beschikbare aanzichtstekeningen.

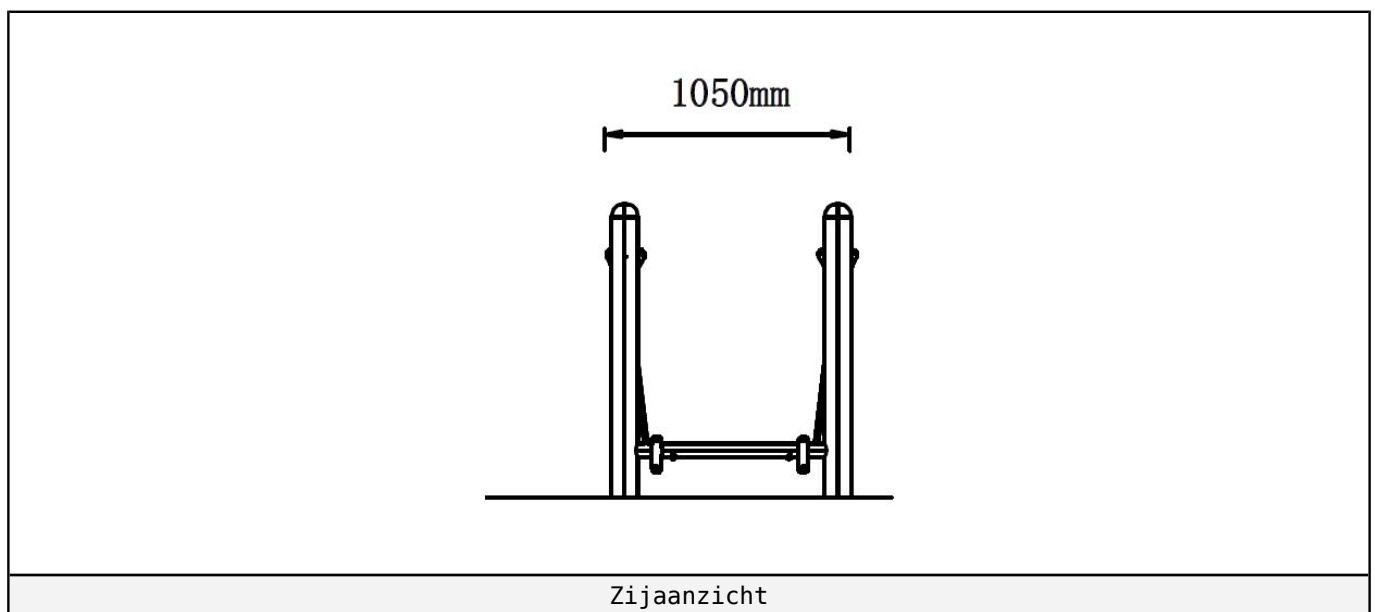
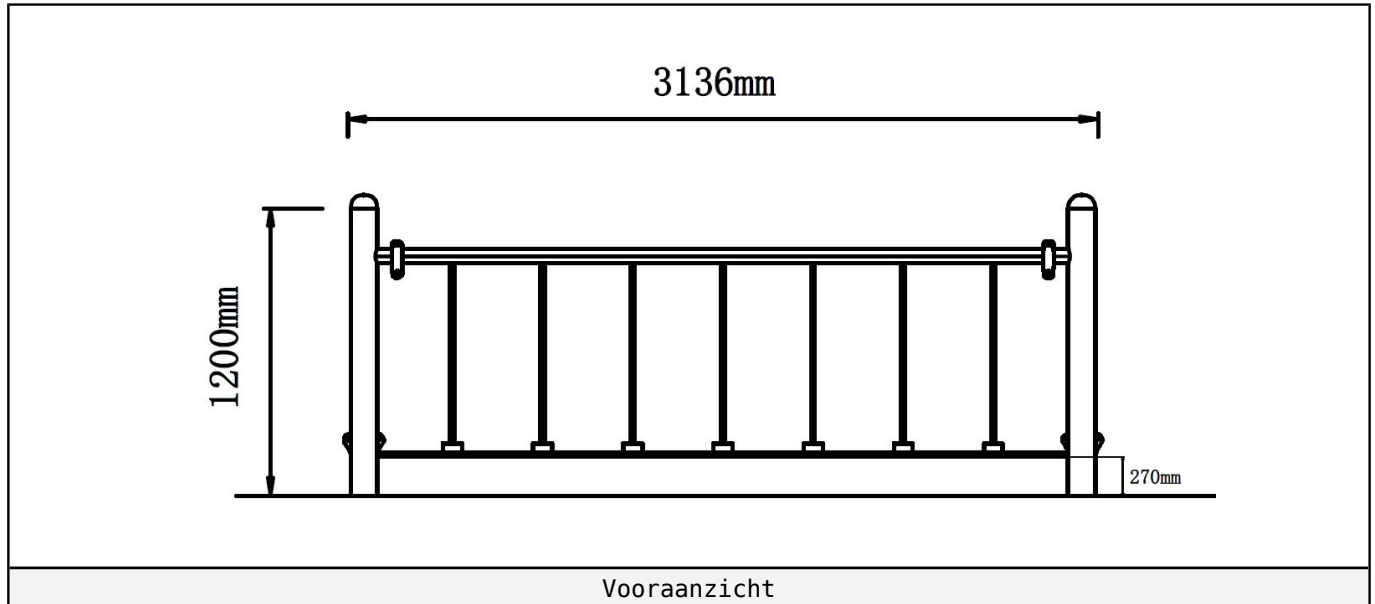

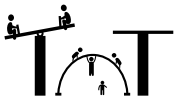

## Plattegrond palenplan

U kunt van deze tekening niet afmeten!

Voor de betonfundatie heeft u 37.5 kg snelbeton per staander nodig.

Houdt u er rekening mee dat de betonfundatie minimaal 400mm onder het maaiveld blijft, zoals op de tekening afgebeeld.

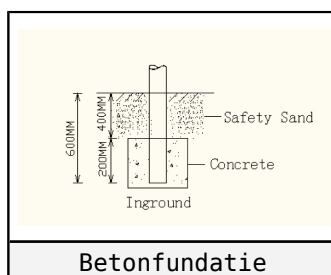
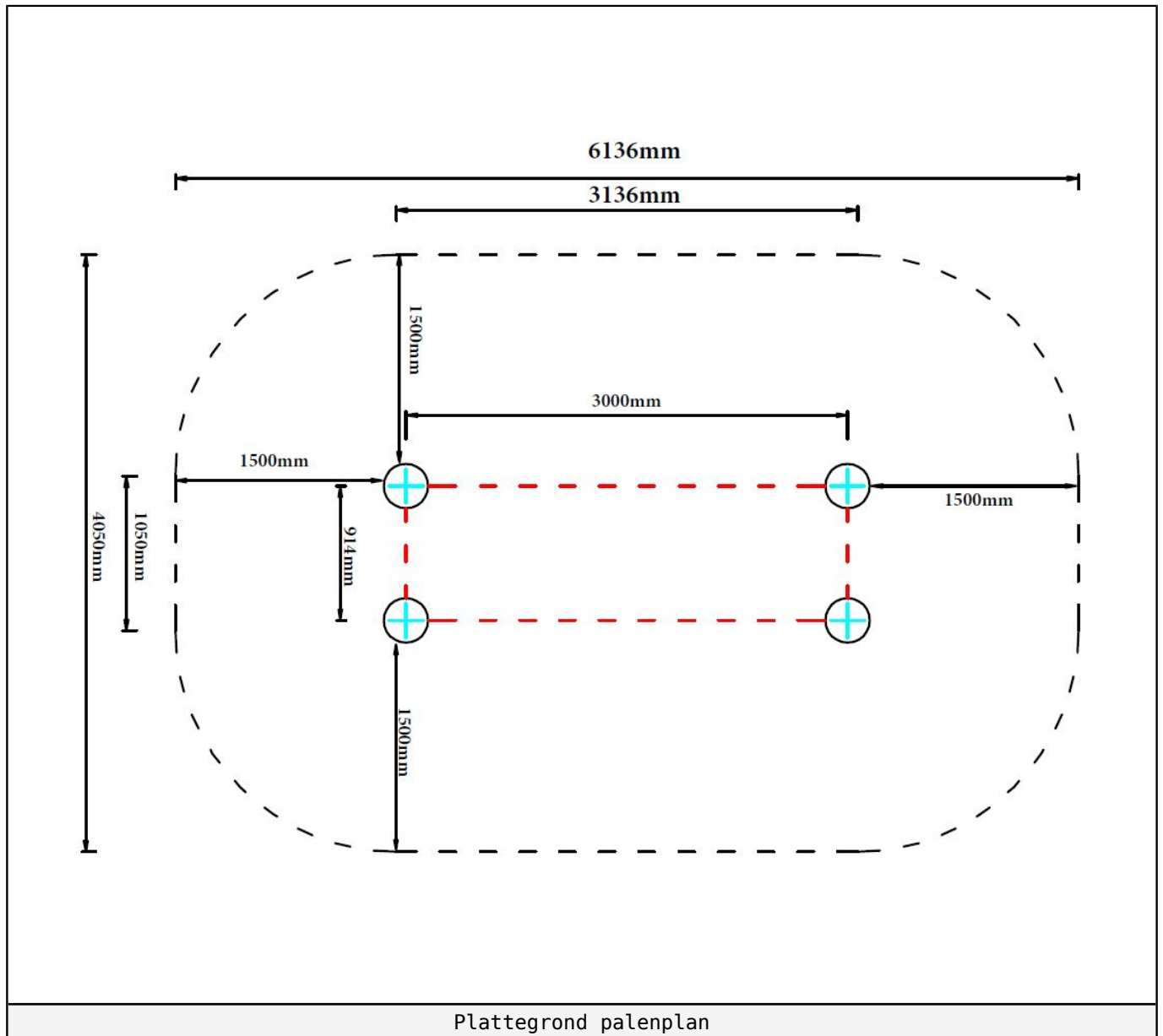

---

## Onderdeel handleidingen

Op de volgende pagina's van dit document vindt u alle individuele onderdelen met bijhorende technische tekeningen en eventuele montage instructies.





### Staander B-061 links

2 STUKS

Hoofdafmetingen: 180x11,5cm

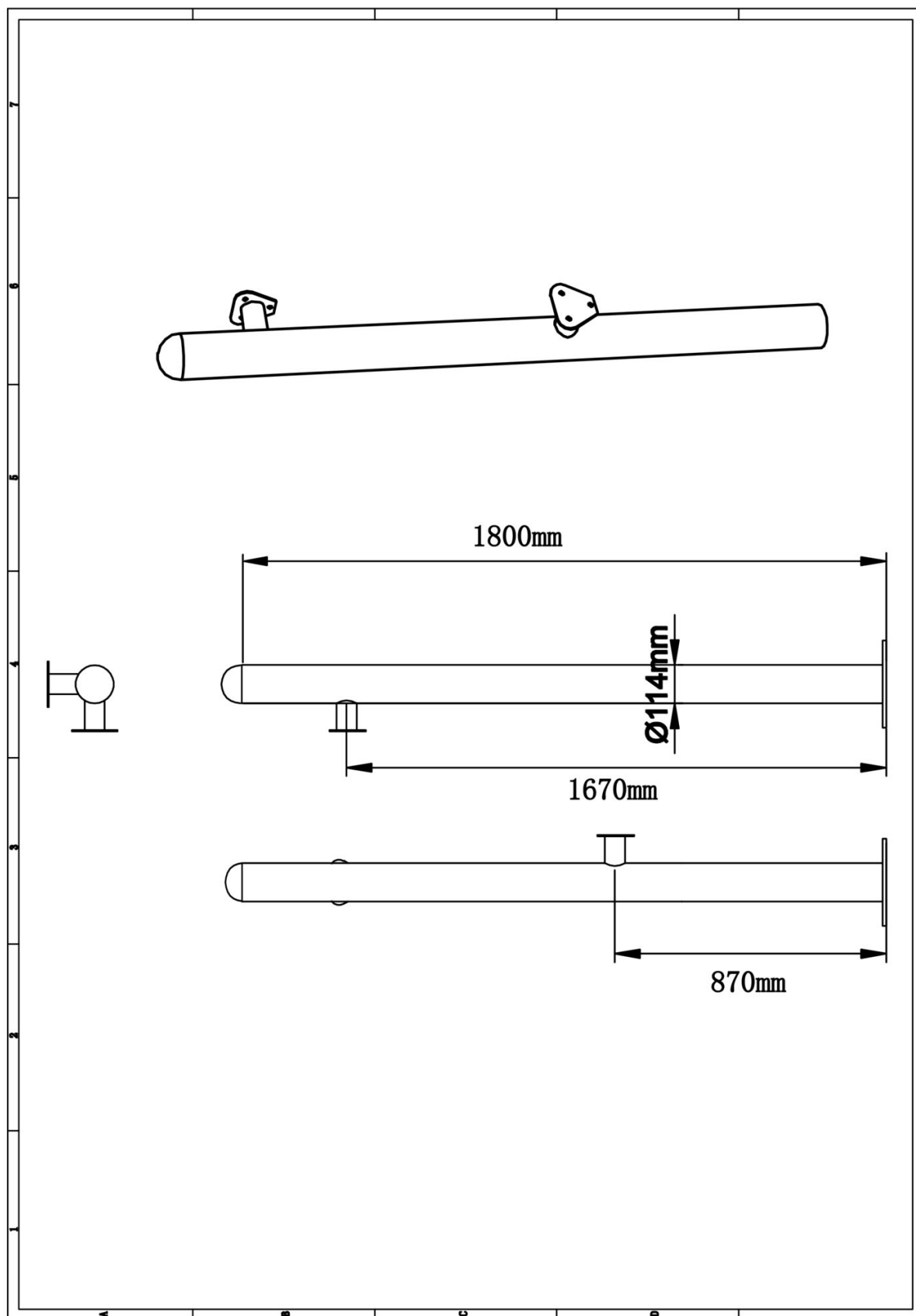

### Staander B-061 links

STAP 1 van 1

**Omschrijving:** Paalkap losdraaien en opnieuw bevestigen met loctite op het draadeind

1 st. Loctite

1 

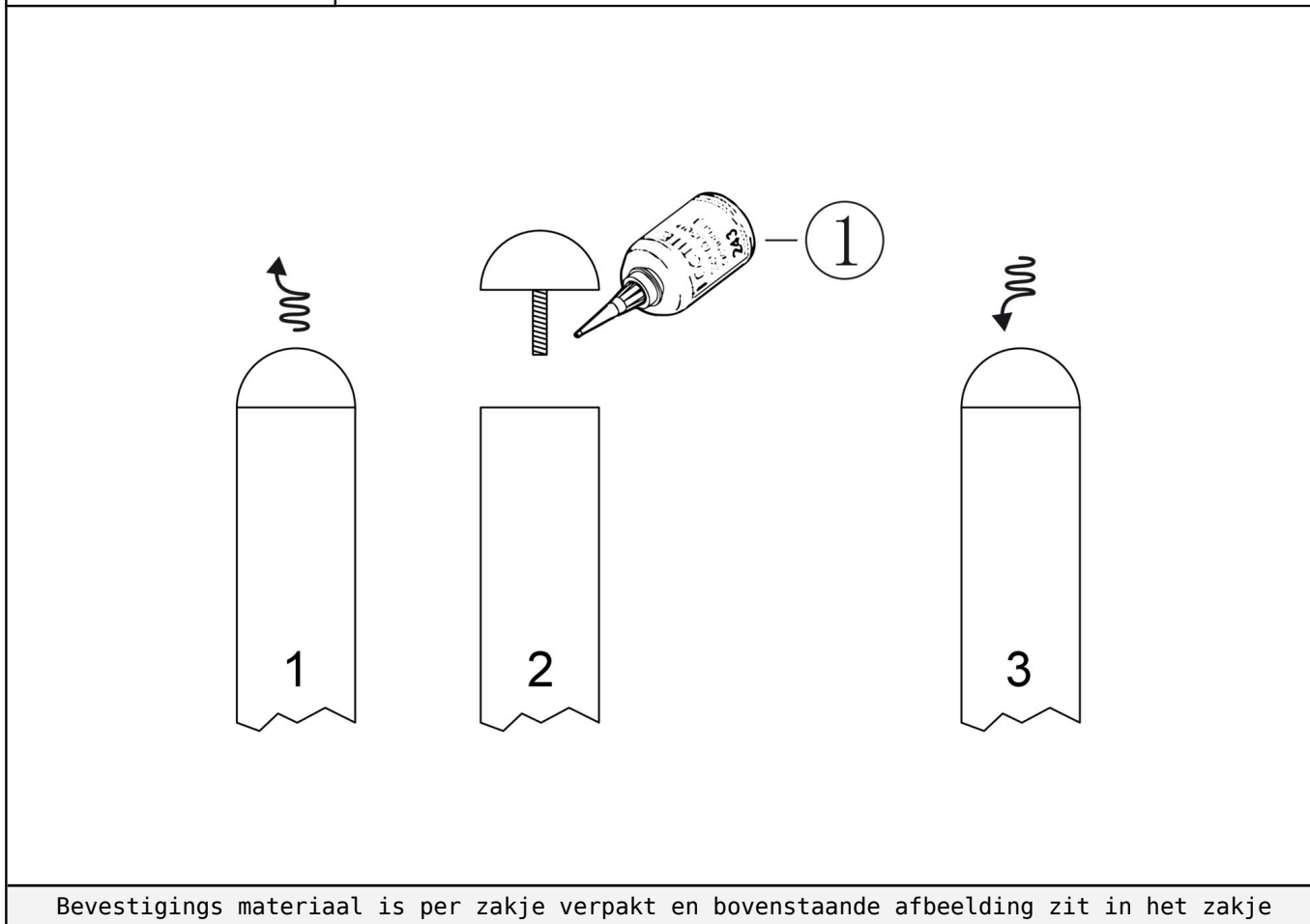



### Staander B-061 rechts

2 STUKS

Hoofdafmetingen: 180x11,5cm

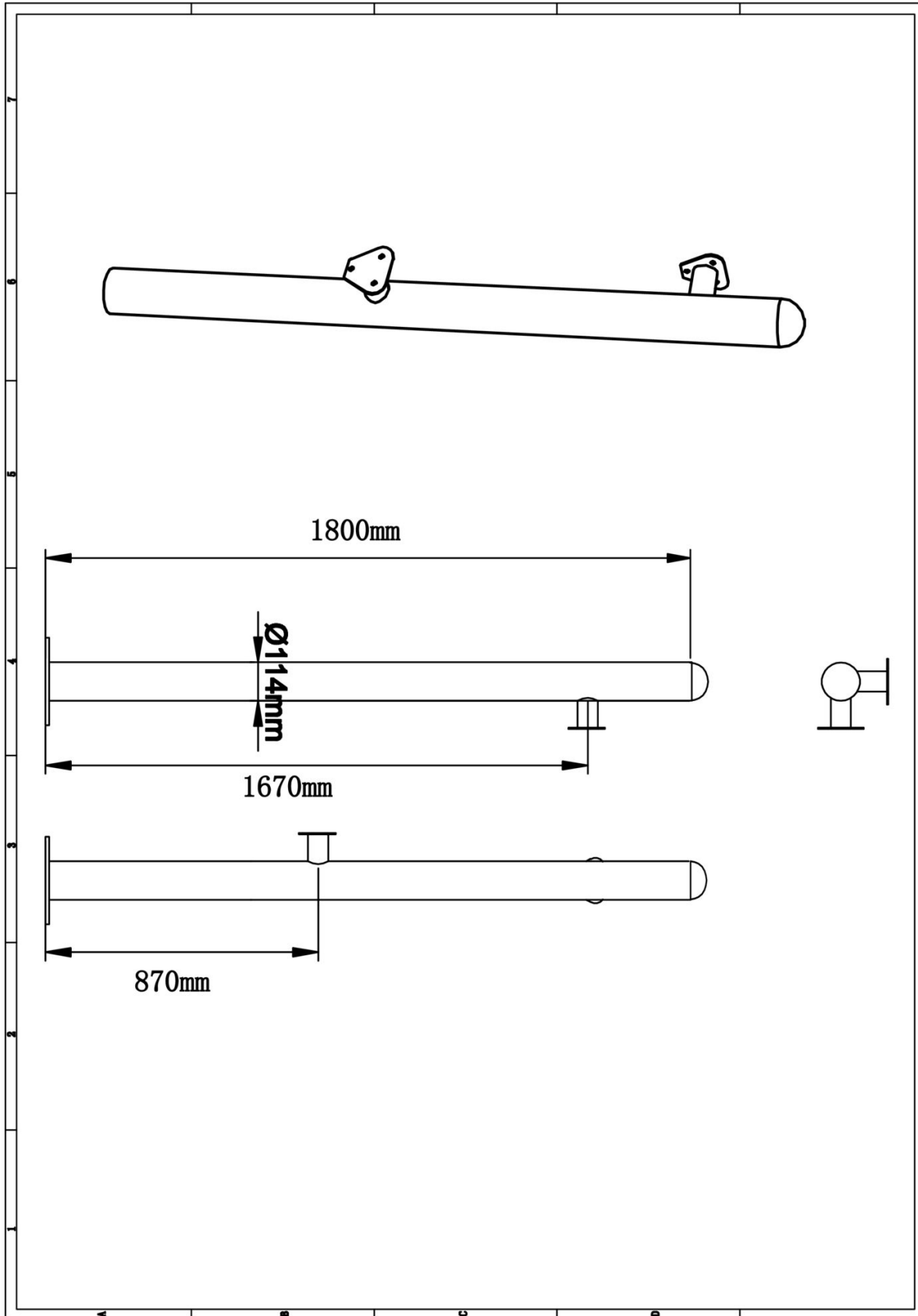

## Staander B-061 rechts

STAP 1 van 1

**Omschrijving:** Paalkap losdraaien en opnieuw bevestigen met loctite op het draadeind

1 st. Loctite

1 

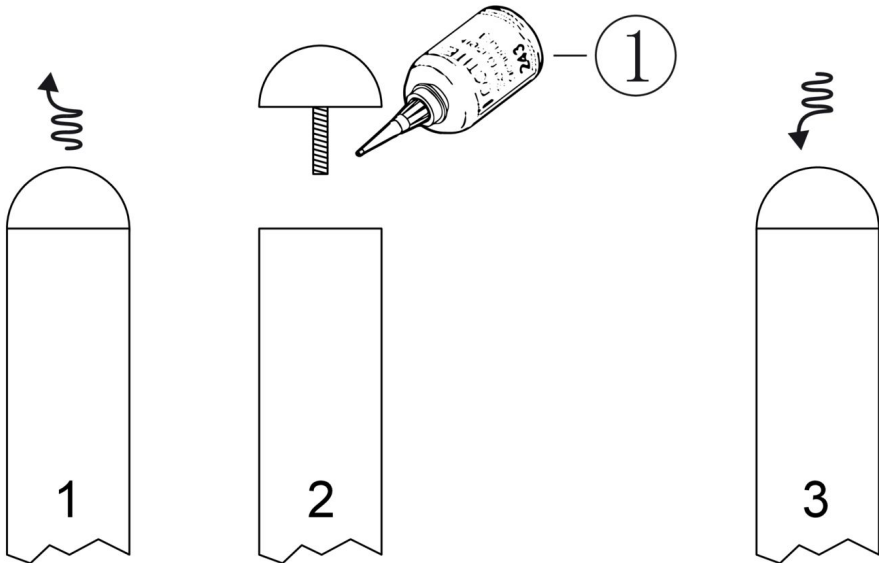

1 2 3

Bevestigings materiaal is per zakje verpakt en bovenstaande afbeelding zit in het zakje

### Balk voor B-061

2 STUKS

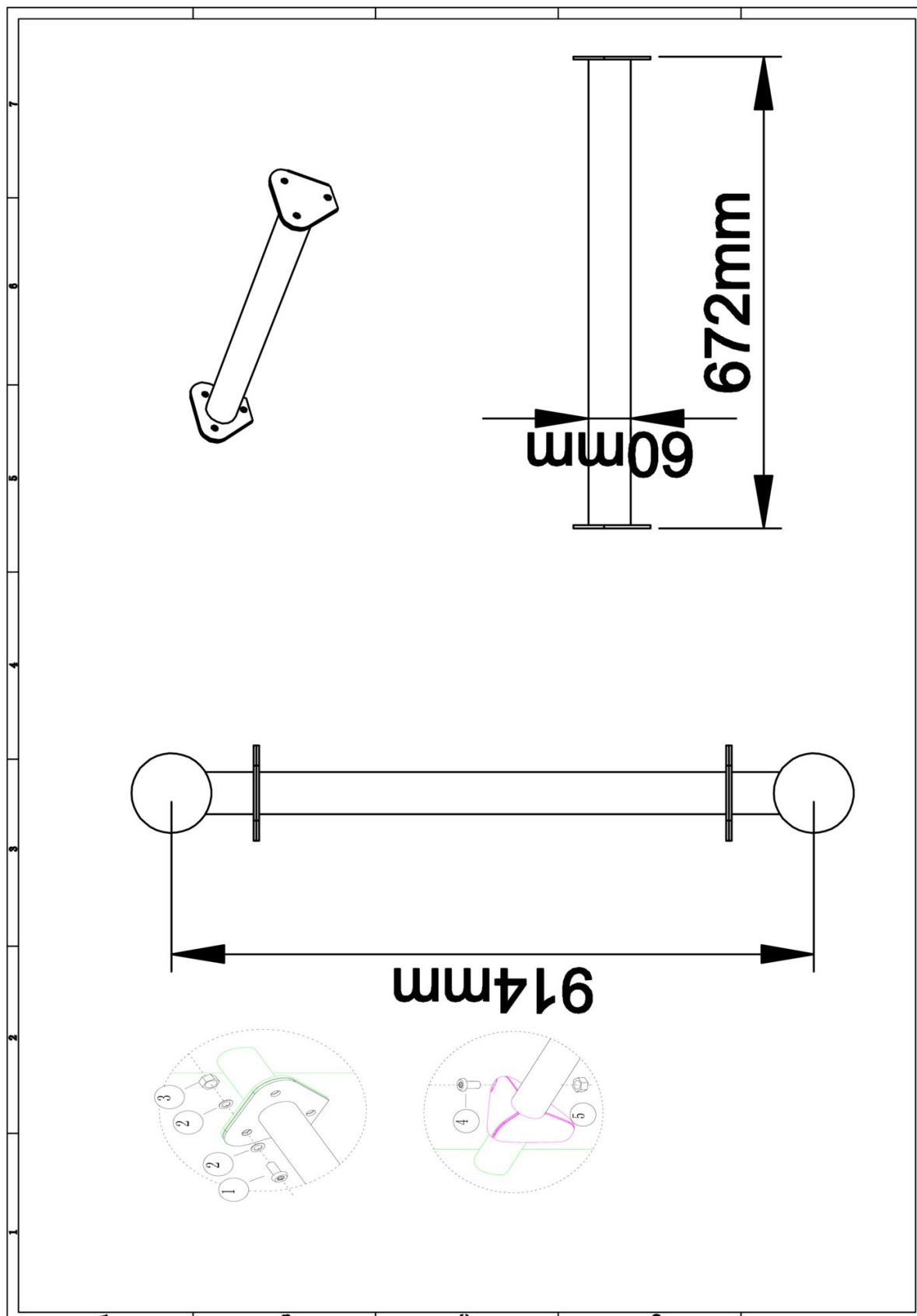

Hoofdafmetingen: 67x6cm



**Balk voor B-061**

STAP 1 van 1

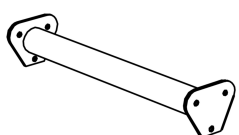
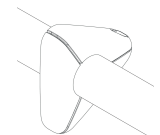
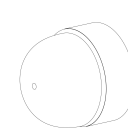
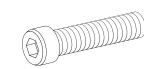
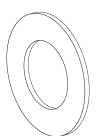
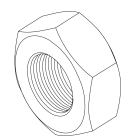
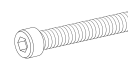
**Omschrijving:** Bevestiging tussen de balk en de staanders

2 st. Balk voor B-061	4 st. Kunststof afdekkap	4 st. Afdekdop M8	12 st. Bout M10X20
			① 
24 st. Ring M10 (middel)	12 st. Lock Moer M10	4 st. Bout M8X30	4 st. Lock Moer M8
② 	③ 	④ 	⑤ 

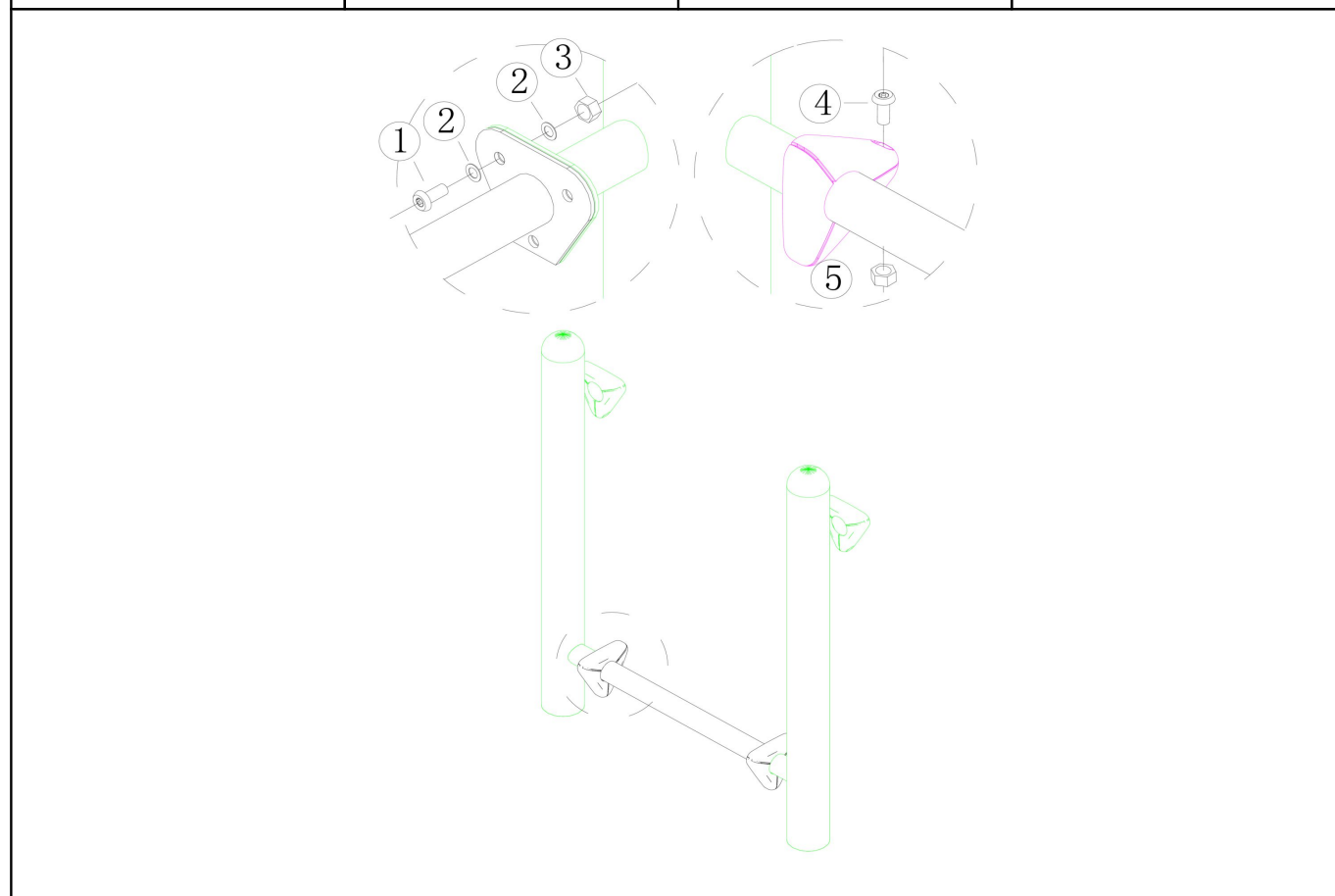

Bevestigings materiaal is per zakje verpakt en bovenstaande afbeelding zit in het zakje



### Brugleuning B-061

2 STUKS

Hoofdafmetingen: 272x6cm

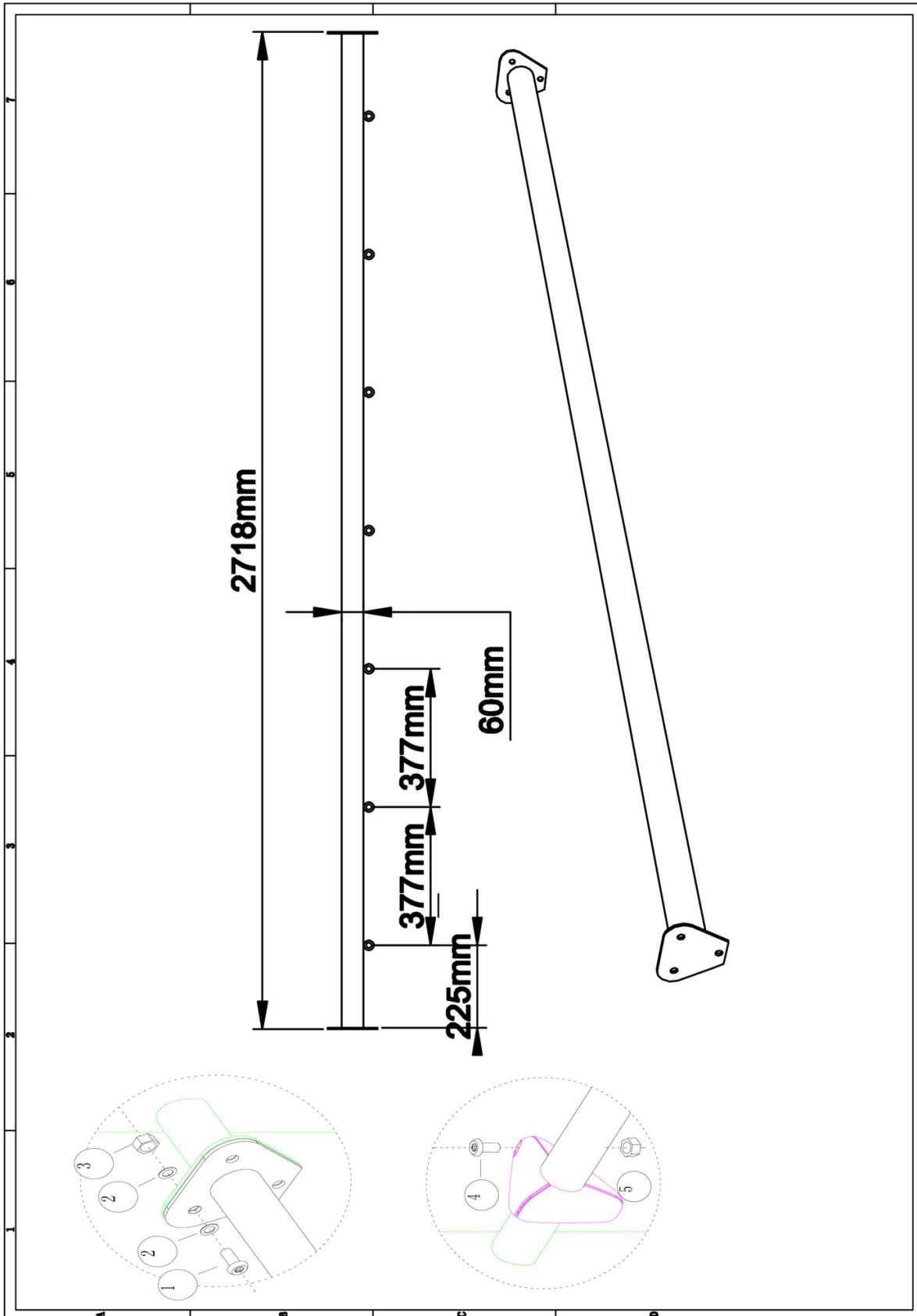

## Brugleuning B-061

STAP 1 van 1

**Omschrijving:** Bevestiging tussen de brugleuningen en de staanders

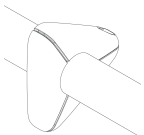
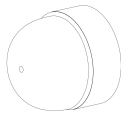
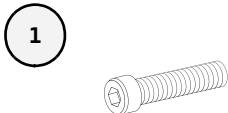
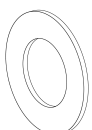
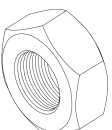
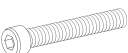
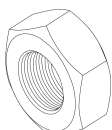
2 st. Brugleuning B-061	4 st. Kunststof afdekkap	4 st. Afdekdop M8	12 st. Bout M10X20
			
24 st. Ring M10 (middel)	12 st. Lock Moer M10	4 st. Bout M8X30	4 st. Lock Moer M8
			

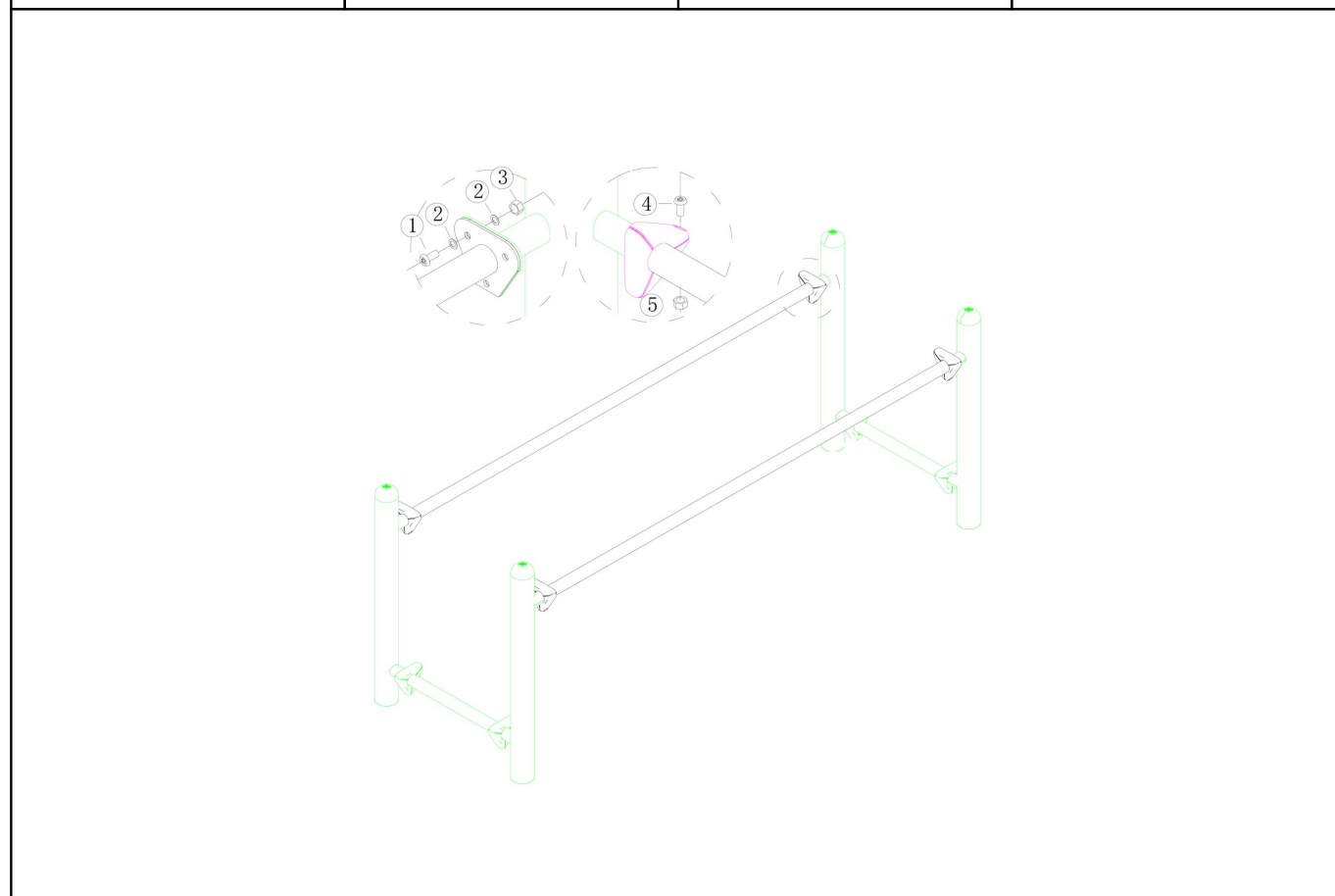

Bevestigings materiaal is per zakje verpakt en bovenstaande afbeelding zit in het zakje



### Brug tredes B-061

7 STUKS

Hoofdafmetingen: 85x8x4cm

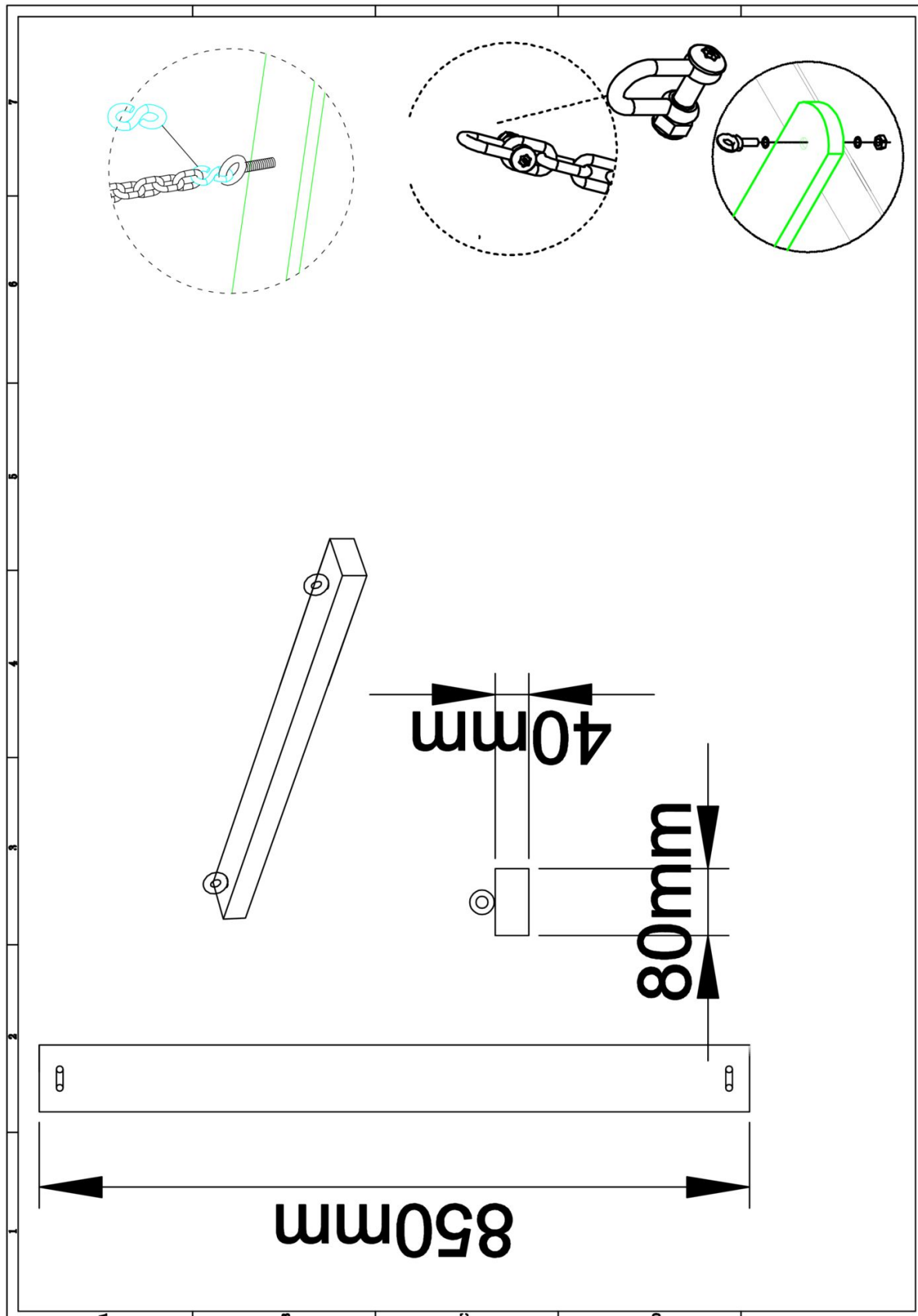

## Brug tredes B-061

STAP 1 van 3

**Omschrijving:** Bevestiging tussen de riem en de balk van de brug

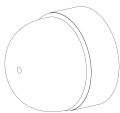
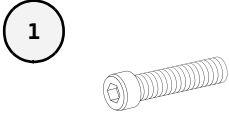
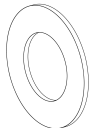
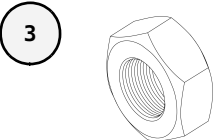
2 st. Brugriem B-061	8 st. Afdekdop M8	8 st. Bout M8X20	16 st. Ring M10 (middel)
			
8 st. Lock Moer M8			
			

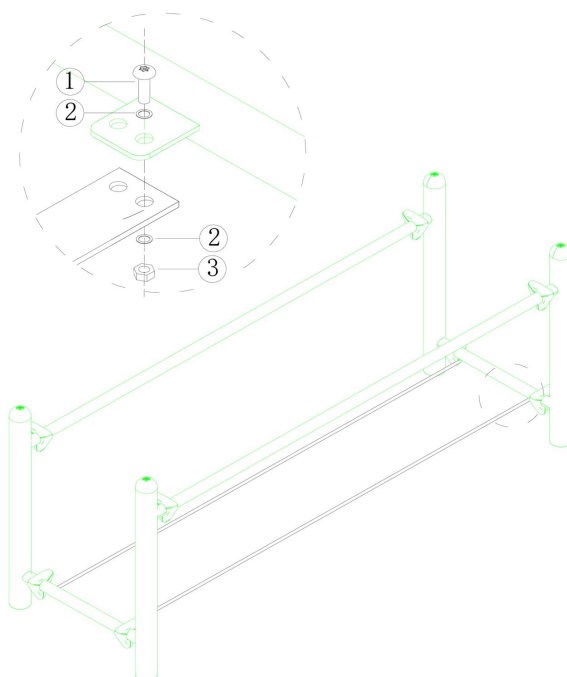

Bevestigings materiaal is per zakje verpakt en bovenstaande afbeelding zit in het zakje

## Brug tredes B-061

STAP 2 van 3

**Omschrijving:** Bevestiging tussen de tredes en de brugleuningen

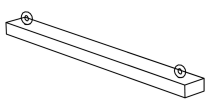
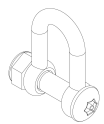
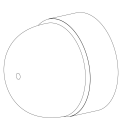
7 st. Brug tredes B-061	14 st. D-haak M8	14 st. Afdekdop M8
		

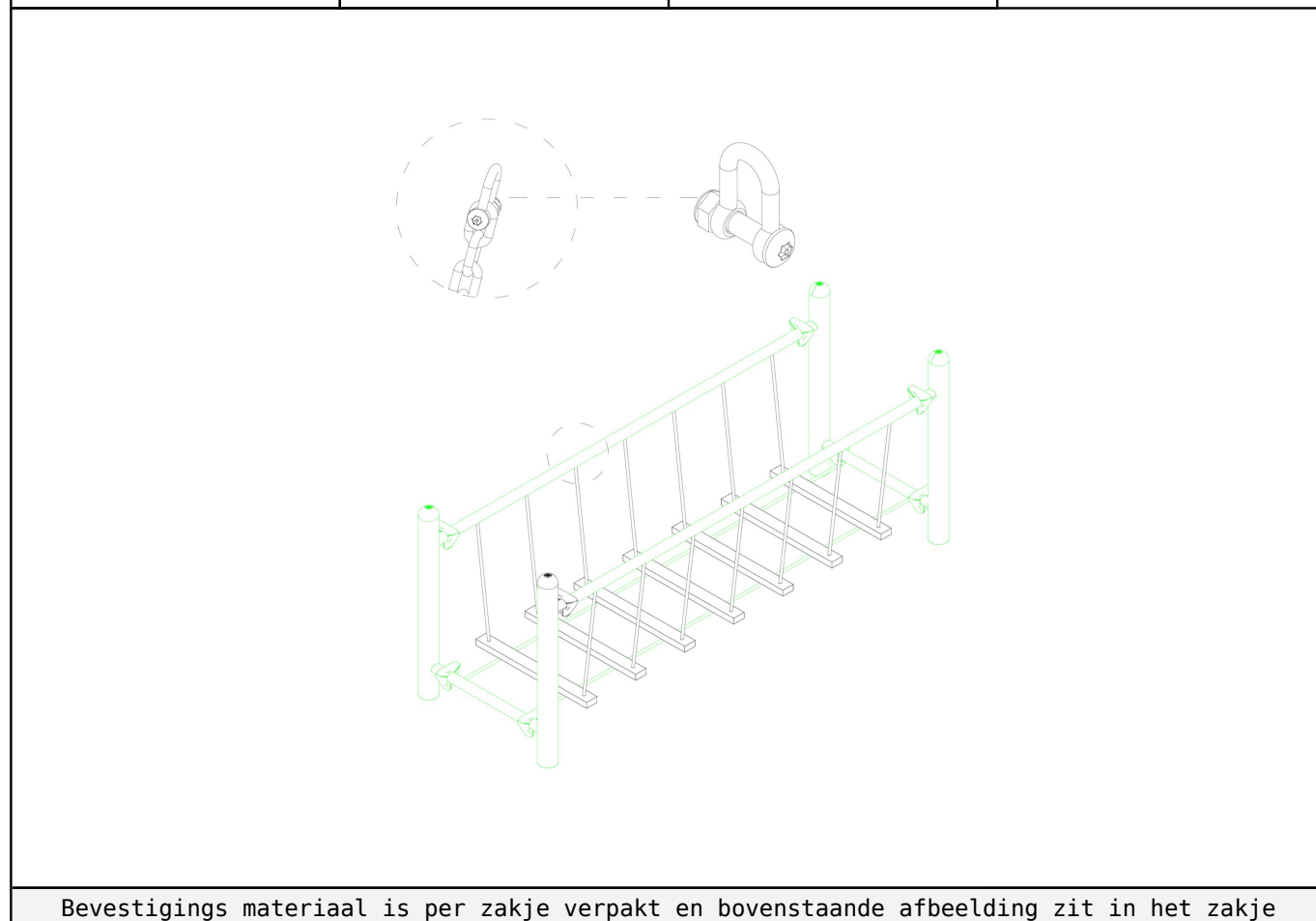

## Brug tredes B-061

STAP 3 van 3

**Omschrijving:** Bevestiging tussen de riem en de tredes

14 st. Afdekdop M10	28 st. Ring M10 (groot)	14 st. Lock Moer M10
		

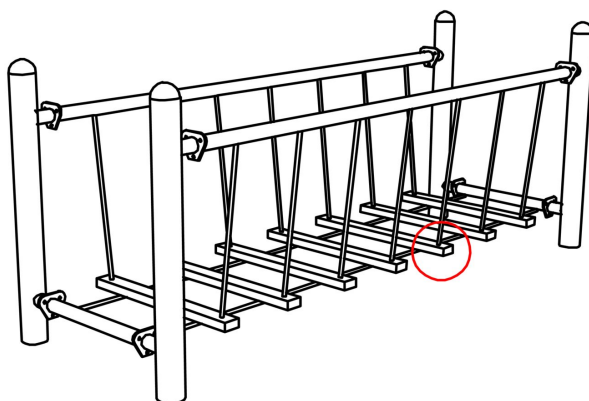
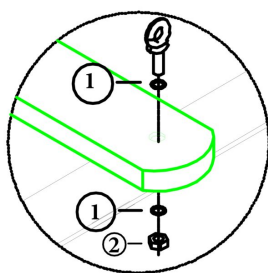

Bevestigings materiaal is per zakje verpakt en bovenstaande afbeelding zit in het zakje