



TnT speeltoestellen

Montagehandleiding K-424



Toestel typenummer	K-424
Datum montagehandleiding	11/12/2017
Versienummer montagehandleiding	2.0

Beste klant van TnT Speeltoestellen,

Wij danken u voor het aanschaffen en installeren van een speeltoestel van TnT Speeltoestellen. Wij waarderen het vertrouwen dat u in ons bedrijf heeft geplaatst en streven ernaar om uw vertrouwen meer dan waar te maken!

Dit is uw TnT speeltoestellen montagehandleiding.

Wij hebben deze handleiding specifiek voor het product ontworpen, waarop eveneens de toe te passen onderdelen zijn genoemd.

Ook vindt u het grondplan met de benodigde valruimte volgens norm NEN-EN1176-1 : 2017.

Bewaart u dit document bij uw logboek. Nogmaals willen wij u bedanken voor de aankoop van dit speeltoestel. Wij zien uit naar uw volgende speelproject.

Met vriendelijke groet, TnT Speeltoestellen



Inhoudsopgave

Aanzichten 3D	3
Onderdelenlijst	4
Veiligheidsruimtes	5
Aanzichten 2D	6
Plattegrond palenplan	7
Onderdeel handleidingen	8
<i>Staander K-424</i>	9
<i>Stang K-424</i>	11
<i>Klimringen K-424</i>	13

Aanzichten 3D





Aanzicht 1

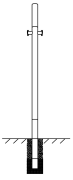

Aanzicht 3

Onderdelenlijst

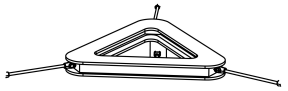
3 st. Staander K-424	3 st. Stang K-424	3 st. Klimringen K-424
330x68x31cm	81x94x11cm	96x83x9cm
		

Veiligheidsruimtes

Geachte klant,

Zorg er altijd voor dat alle veiligheids ruimtes zoals aangegeven in ieder geval gehaald worden, dit zijn de minimale vereiste ruimtes voor een veilig gebruik van het speeltoestel.

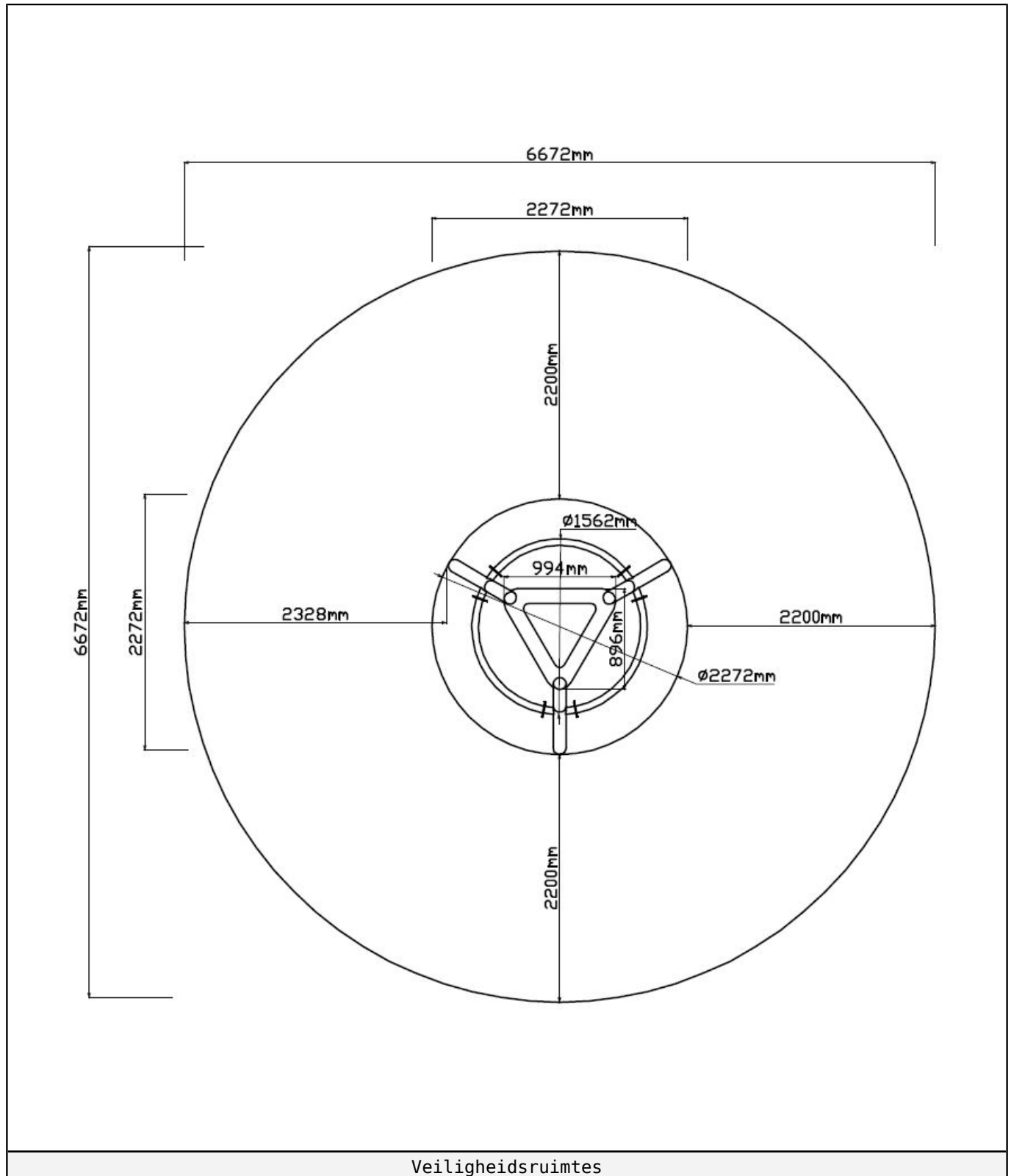

Aanzichten 2D

Hier vindt u de beschikbare aanzichtstekeningen.

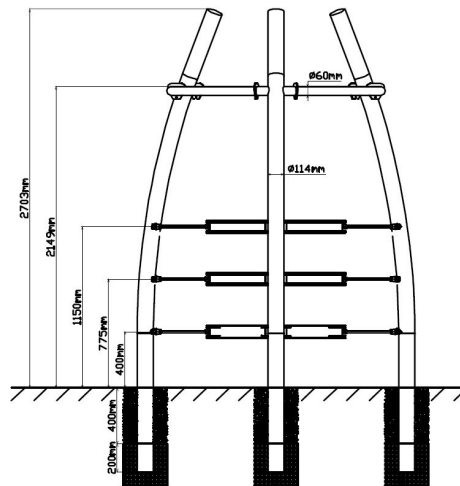

Vooraanzicht

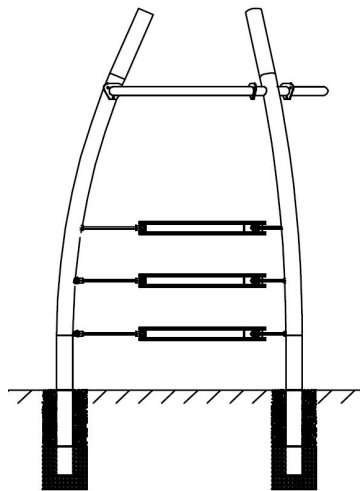

Zijaanzicht



Plattegrond palenplan

U kunt van deze tekening niet afmeten!

Voor de betonfundatie heeft u 50 kg snelbeton per staander nodig.

Houdt u er rekening mee dat de betonfundatie minimaal 400mm onder het maaiveld blijft, zoals op de tekening afgebeeld.

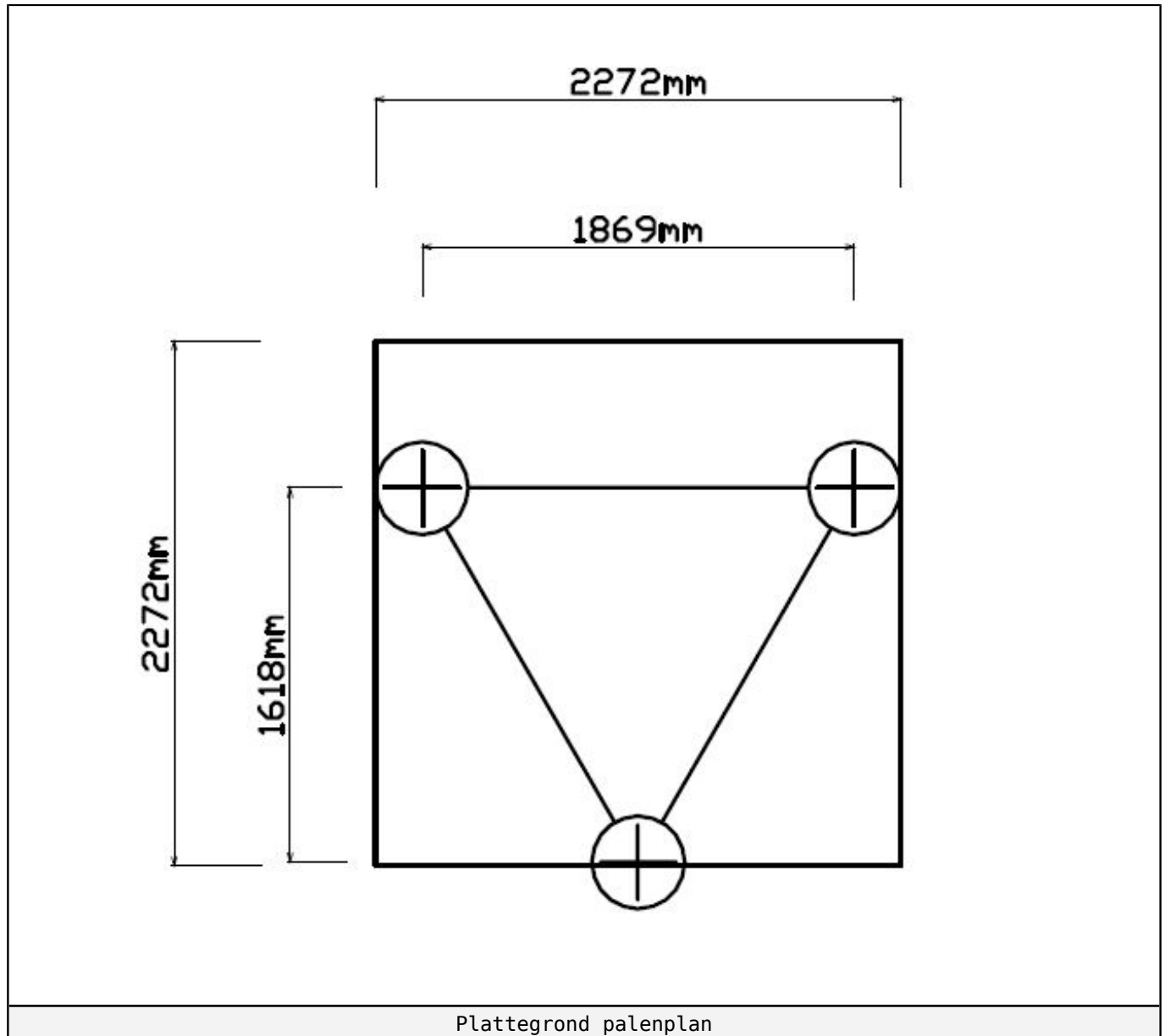

Plattegrond palenplan

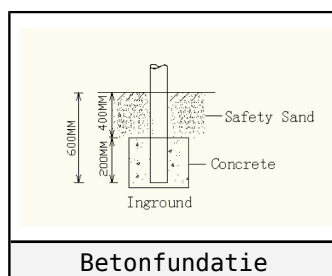

Betonfundatie



Onderdeel handleidingen

Op de volgende pagina's van dit document vindt u alle individuele onderdelen met bijhorende technische tekeningen en eventuele montage instructies.



Staander K-424

3 STUKS

Hoofdafmetingen: 330x68x31cm

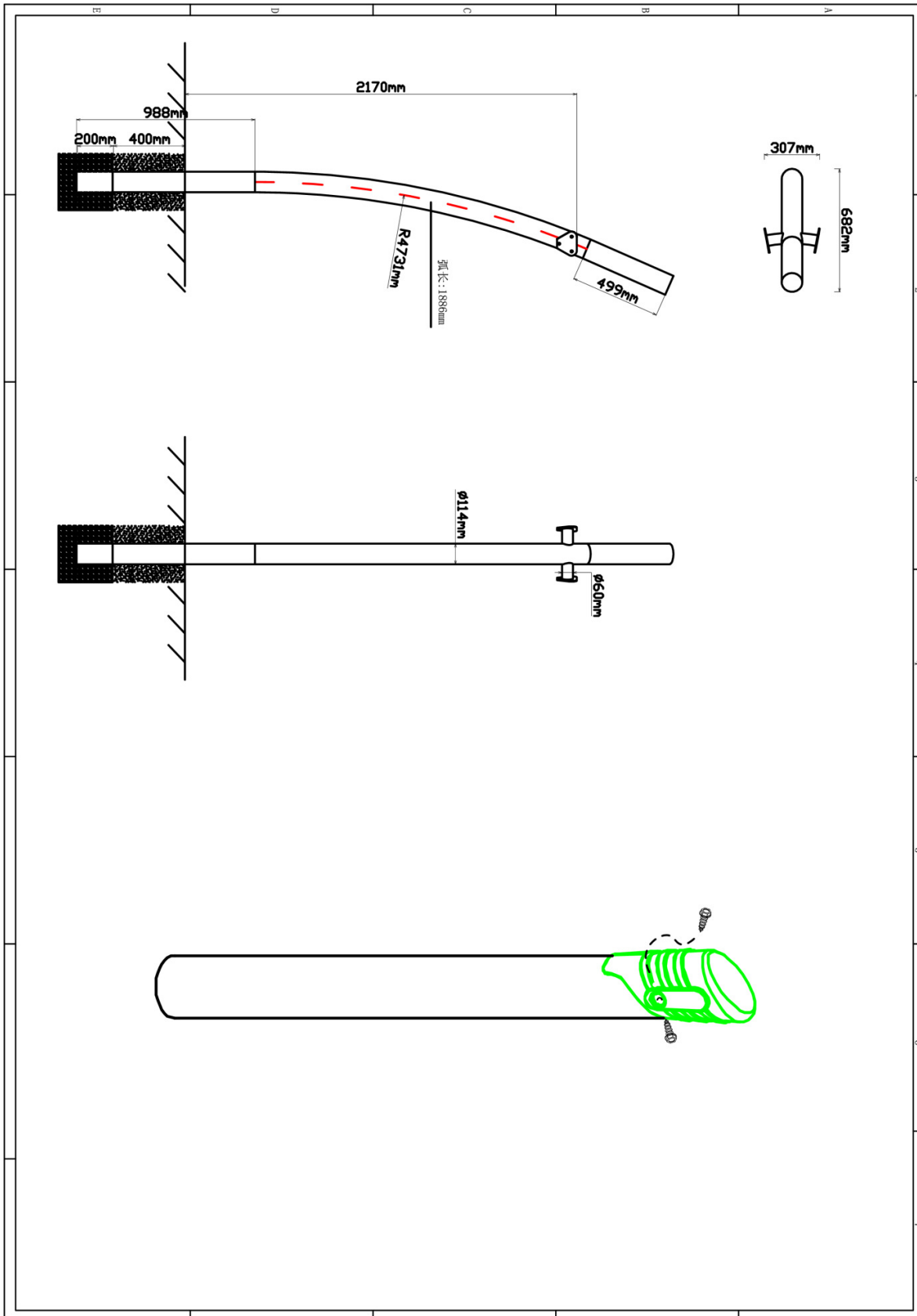

Staander K-424

STAP 1 van 1

Omschrijving: Bevestiging van de paalkap op de staander

1 st. Kunststof paalkap	2 st. Kruiskop M3X16 Zelftap
	

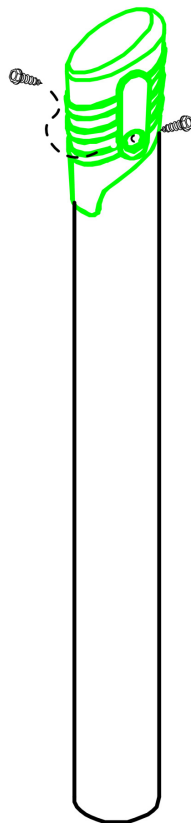

Bevestigings materiaal is per zakje verpakt en bovenstaande afbeelding zit in het zakje



Stang K-424

3 STUKS



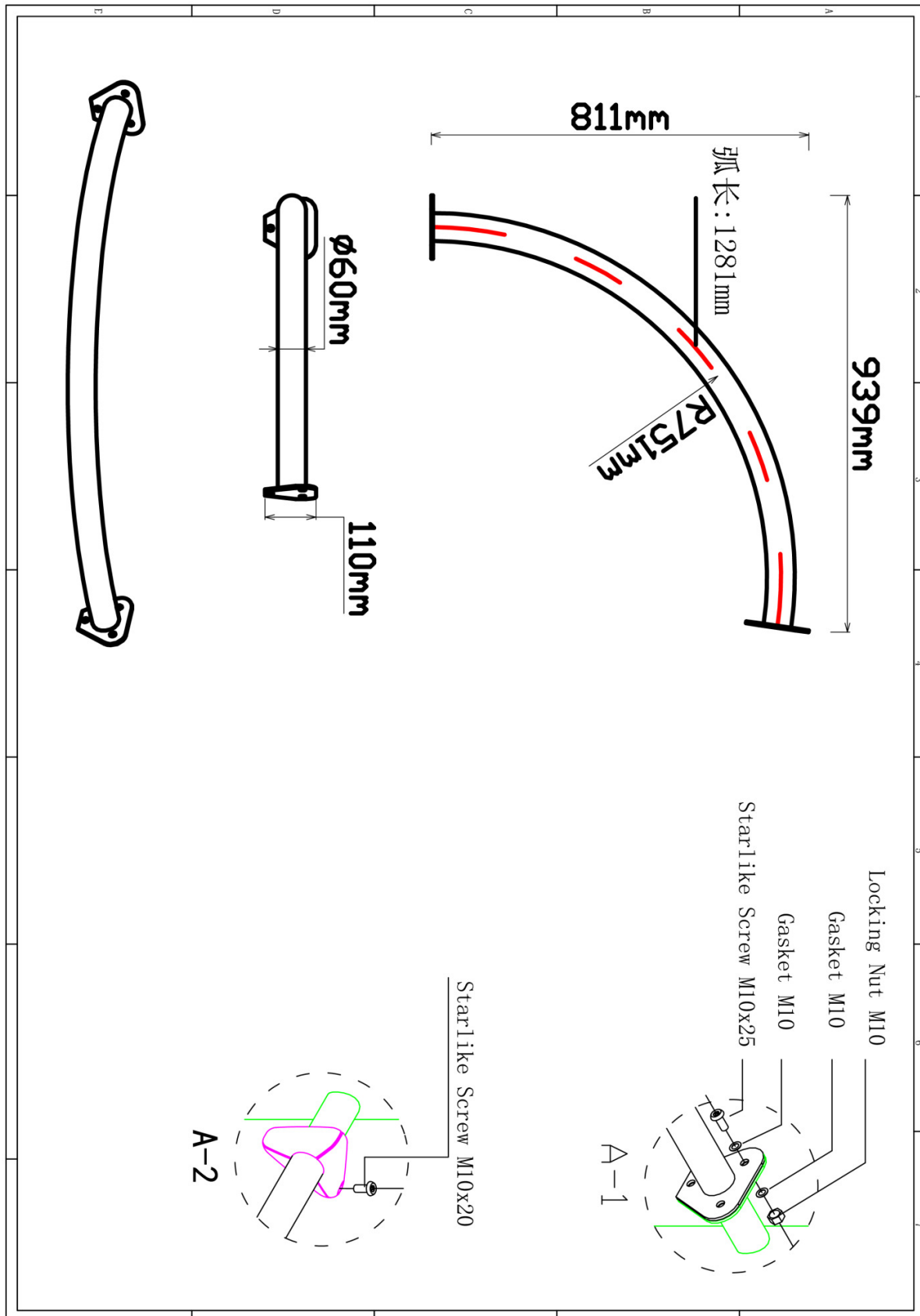

Hoofdafmetingen: 81x94x11cm

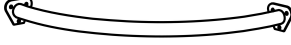
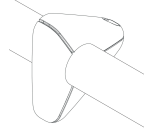
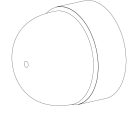
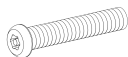
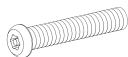
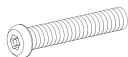
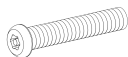
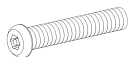
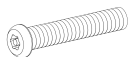

Stang K-424

STAP 1 van 1

Omschrijving: Bevestiging tussen de stang en de standers en bevestiging van de beschermkap

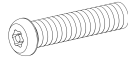
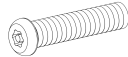
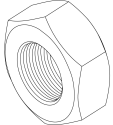
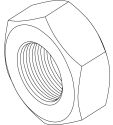
1 st. Stang K-424	2 st. Kunststof afdekkap	2 st. Afdekdop M8	6 st. Torx M10X25
			     
12 st. Ring M10 (middel)	6 st. Lock Moer M10	2 st. Torx M8X20	2 st. Lock Moer M8
 	 	 	 

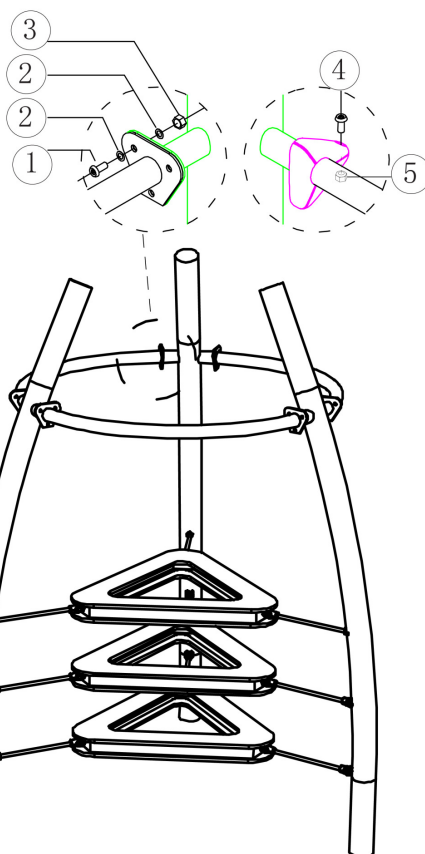

Bevestigings materiaal is per zakje verpakt en bovenstaande afbeelding zit in het zakje

Klimringen K-424

3 STUKS

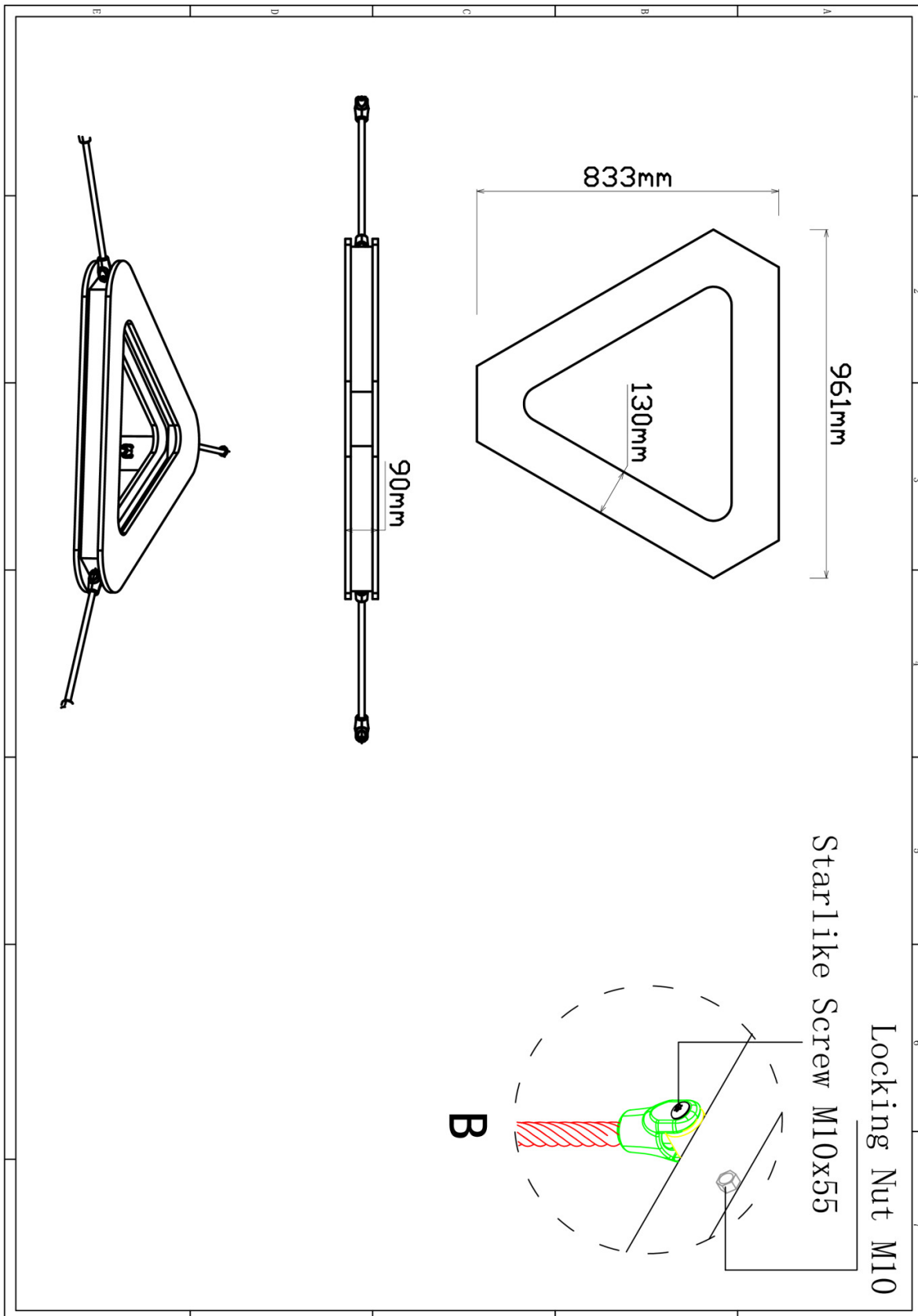

Hoofdafmetingen: 96x83x9cm



Klimringen K-424

STAP 1 van 1

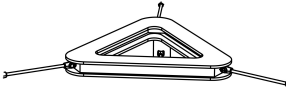
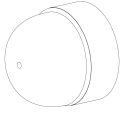
Omschrijving: Bevestiging tussen de klimringen en de staanders

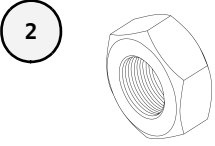
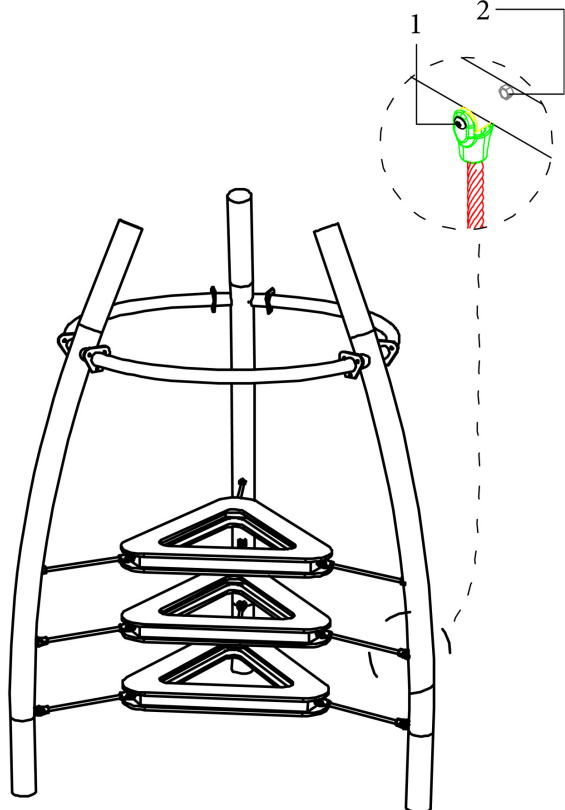
1 st. Klimringen K-424	6 st. Afdekdop M10	3 st. Torx M10X55	3 st. Lock Moer M10
			
			
Bevestigings materiaal is per zakje verpakt en bovenstaande afbeelding zit in het zakje			