

# TnT speeltoestellen

## Montagehandleiding B-095

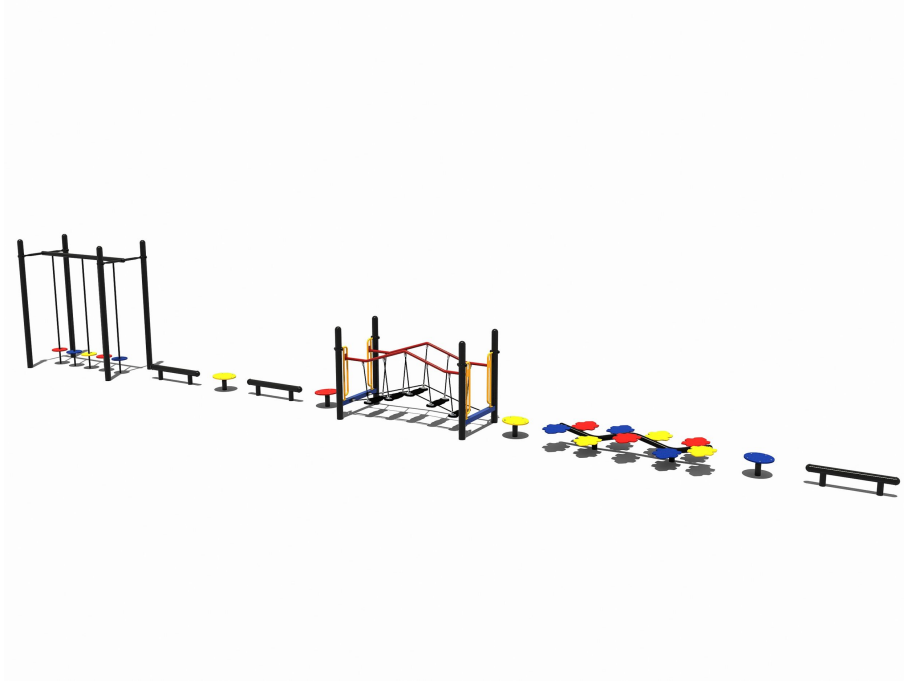

---

Toestel typenummer	<b>B-095</b>
Datum montagehandleiding	<b>17/09/2024</b>
Versienummer montagehandleiding	<b>2.0</b>

---

Beste klant van TnT Speeltoestellen,

Wij danken u voor het aanschaffen en installeren van een speeltoestel van TnT Speeltoestellen. Wij waarderen het vertrouwen dat u in ons bedrijf heeft geplaatst en streven ernaar om uw vertrouwen meer dan waar te maken!

Dit is uw TnT speeltoestellen montagehandleiding.

Wij hebben deze handleiding specifiek voor het product ontworpen, waarop eveneens de toe te passen onderdelen zijn genoemd.

Ook vindt u het grondplan met de benodigde valruimte volgens norm NEN-EN1176-1 : 2017.

Bewaart u dit document bij uw logboek. Nogmaals willen wij u bedanken voor de aankoop van dit speeltoestel. Wij zien uit naar uw volgende speelproject.

Met vriendelijke groet, TnT Speeltoestellen



## Inhoudsopgave

Aanzichten 3D .....	3
Onderdelenlijst .....	4
Veiligheidsruimtes .....	5
Aanzichten 2D .....	6
Plattegrond palenplan .....	7
Onderdeel handleidingen .....	8
<i>Staander 300cm</i> .....	9
<i>Steppenbrug Parcour</i> .....	11
<i>Brug voor B-098</i> .....	16
<i>B-065</i> .....	23
<i>Evenwichtsbalk</i> .....	24
<i>Pe Step B-098</i> .....	25

## Aanzichten 3D

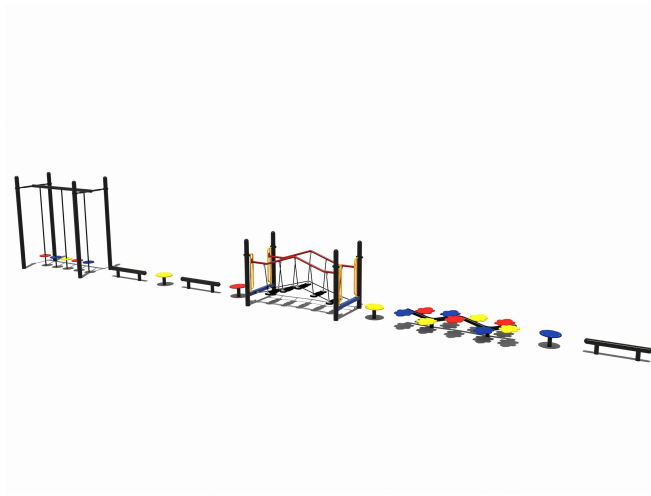

Aanzicht 1

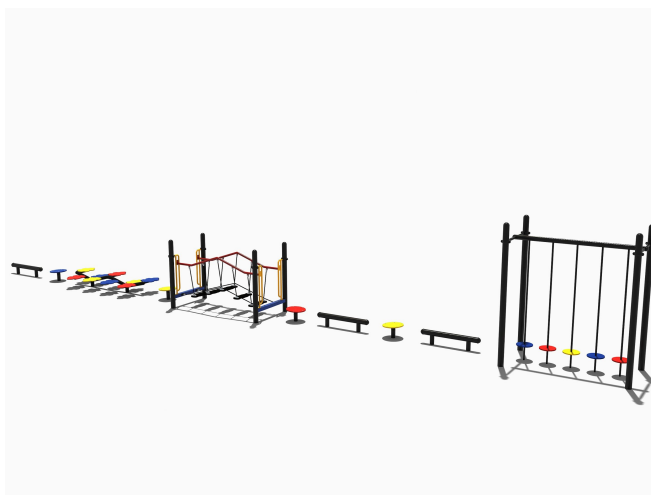

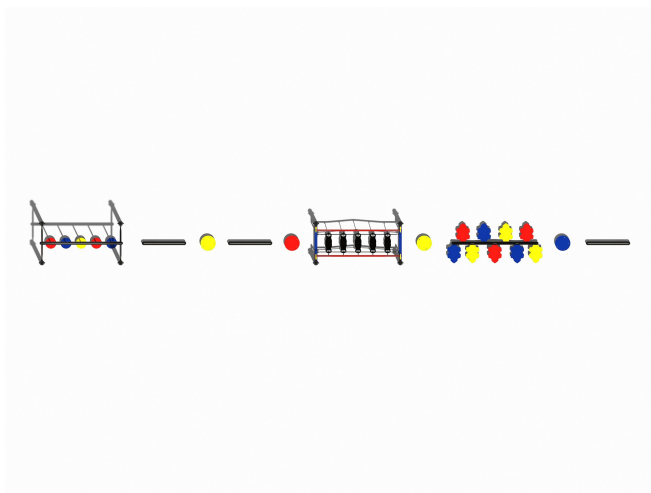

Aanzicht 2

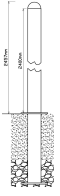

Aanzicht 3

## Onderdelenlijst

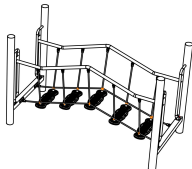
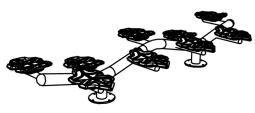
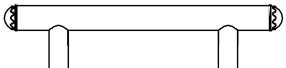
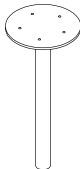
<p><b>4 st. Staander 300cm</b></p>	<p><b>1 st. Steppenbrug Parcour</b></p>	<p><b>1 st. Brug voor B-098</b></p>	<p><b>1 st. B-065</b></p>
<p>300x11,5</p>	<p>101x233x280cm</p>	<p>261x128x168cm</p>	<p>272x934x989cm</p>
			
<p><b>3 st. Evenwichtsbalk</b></p>	<p><b>4 st. Pe Step B-098</b></p>		
<p>131x12x100</p>	<p>Ø45x102</p>		
			



## Aanzichten 2D

Hier vindt u de beschikbare aanzichtstekeningen.

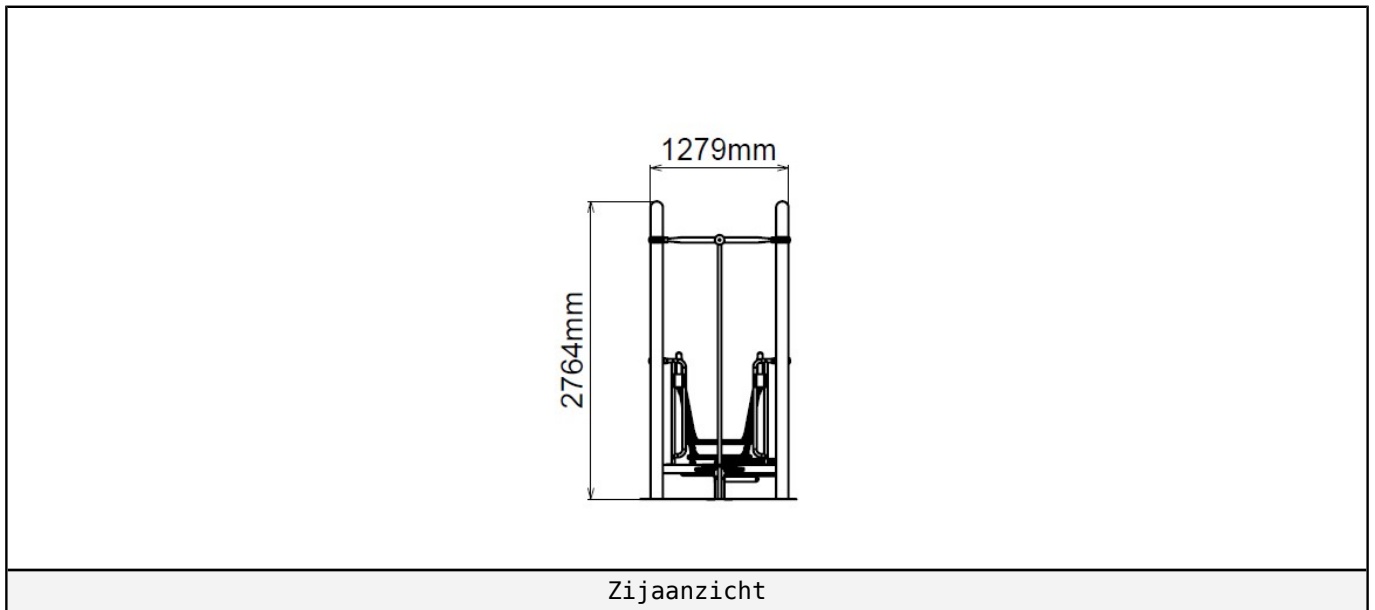
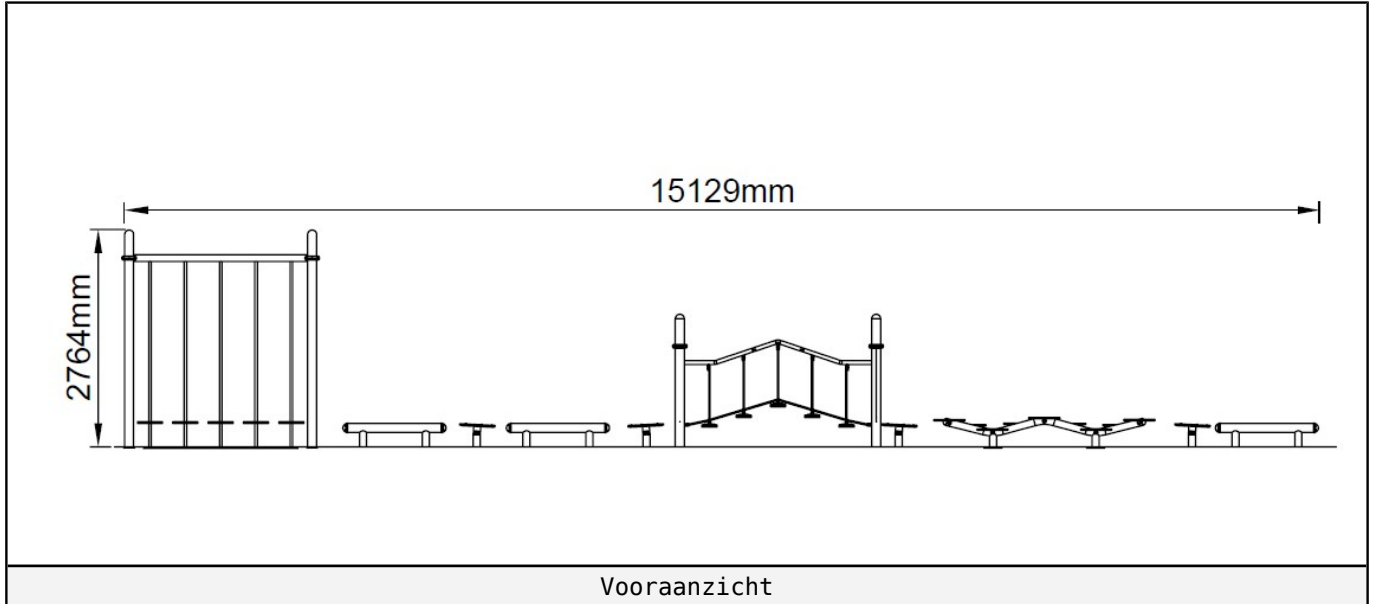



## Plattegrond palenplan

U kunt van deze tekening niet afmeten!

Voor de betonfundatie heeft u 50 kg snelbeton per staander nodig, voor de overige onderdelen 25 kg snelbeton.

Houdt u er rekening mee dat de betonfundatie minimaal 400mm onder het maaiveld blijft, zoals op de tekening afgebeeld.

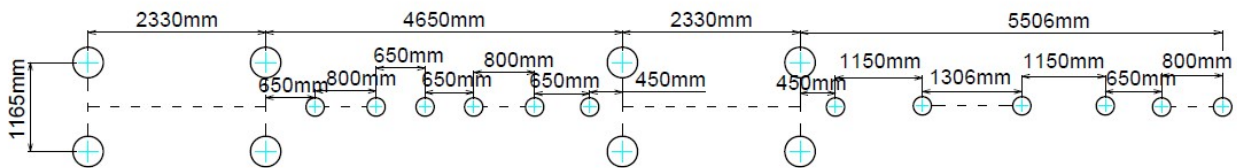

Plattegrond palenplan

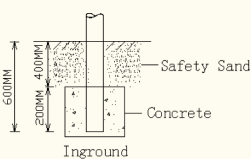

Betonfundatie



## Onderdeel handleidingen

Op de volgende pagina's van dit document vindt u alle individuele onderdelen met bijhorende technische tekeningen en eventuele montage instructies.



# Staander 300cm

4 STUKS

Hoofdafmetingen: 300x11,5

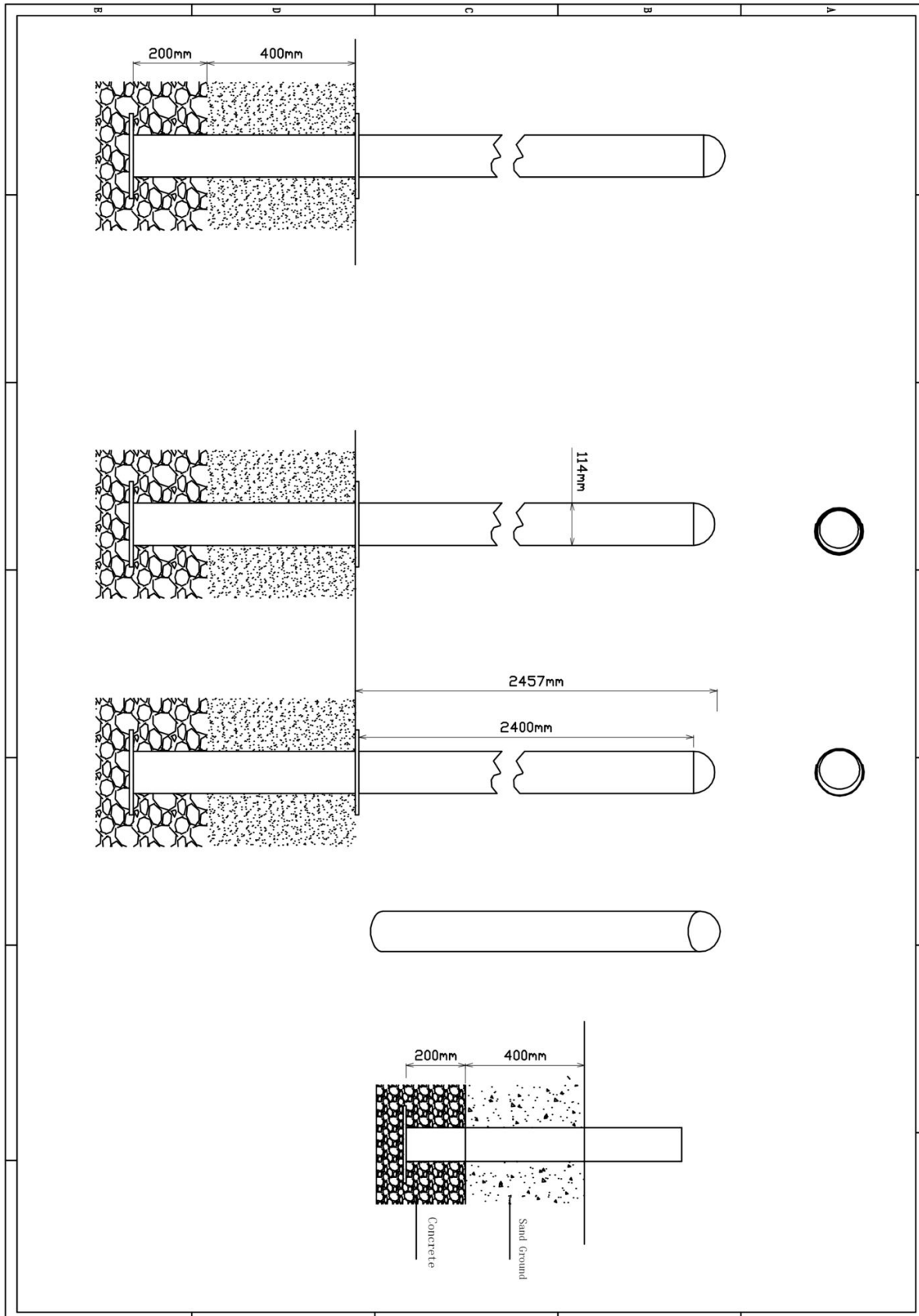



### Staander 300cm

STAP 1 van 1

Omschrijving: Paalkap losdraaien en opnieuw bevestigen met loctite op het draadeind

1 st. Loctite

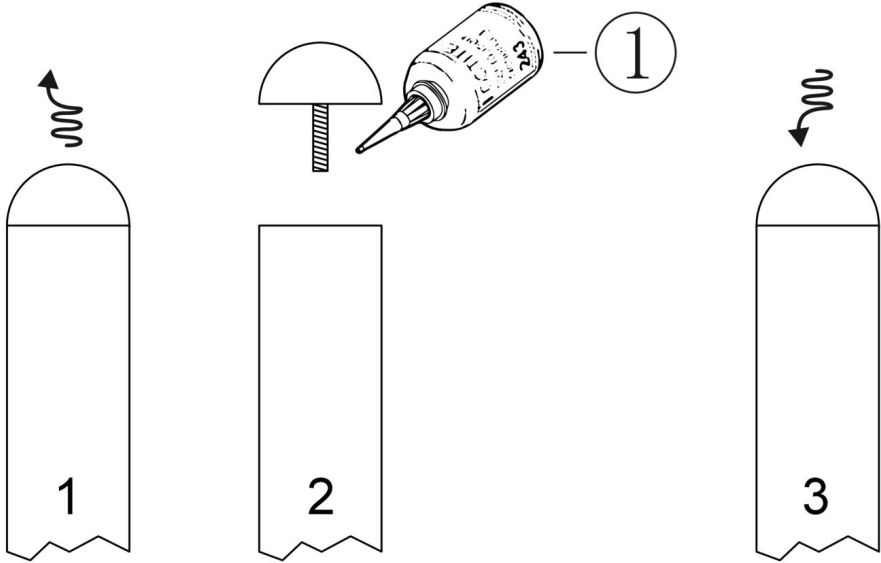
1



1

2

3

Bevestigings materiaal is per zakje verpakt en bovenstaande afbeelding zit in het zakje



# Steppenbrug Parcour

1 STUK

Hoofdafmetingen: 101x233x280cm

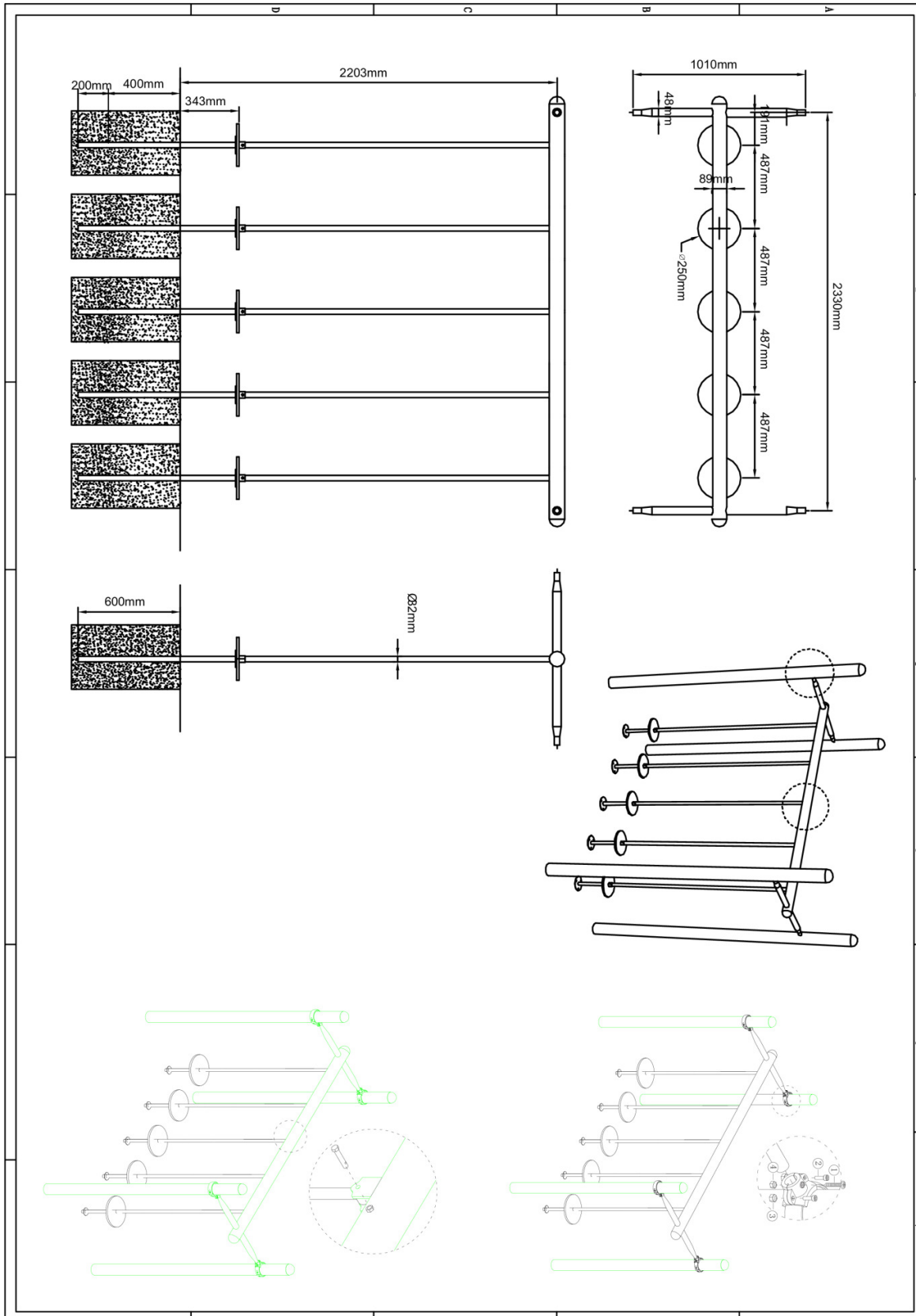

## Steppenbrug Parcour

STAP 1 van 4

**Omschrijving:** Zelftapschroef aanbrengen aan de binnenkant van de palen op 10cm onder de paalkap gemeten

4 st. Zeskant M3X16 Zelftap

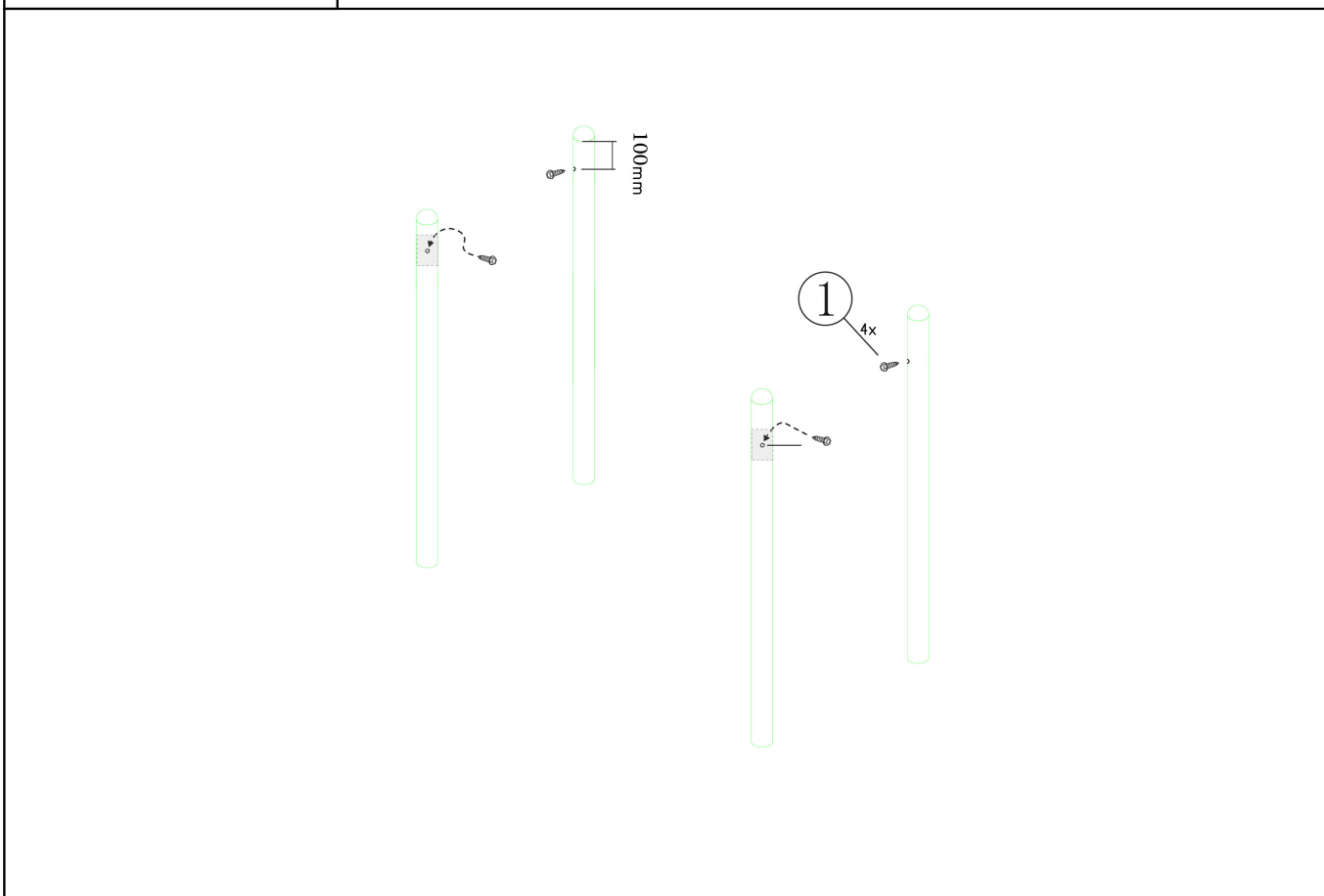
Bevestigings materiaal is per zakje verpakt en bovenstaande afbeelding zit in het zakje



## Zeskant M3X16 Zelftap

STAP 2 van 4

**Omschrijving:** Koppelingsring over de schroef schuiven en vastzetten zodat de schroef niet meer zichtbaar is en de ring door de schroef niet kan zakken op de paal

4 st. Small clamp + ring

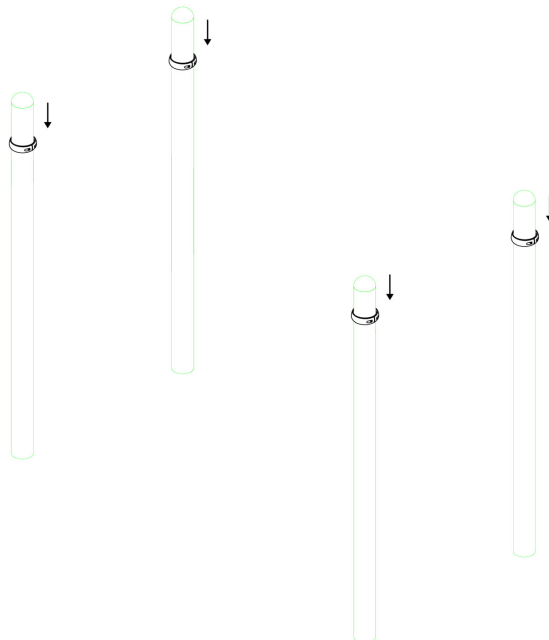



Bevestigings materiaal is per zakje verpakt en bovenstaande afbeelding zit in het zakje

## Small clamp + ring

STAP 3 van 4

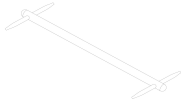
**Omschrijving:** Bevestiging tussen het rek en de standers

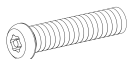
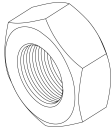
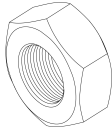
<b>1 st. Los rek (Steppenbrug)</b>	<b>4 st. Kruiskop M6X65</b>	
		
<b>8 st. Torx M8X20</b>	<b>8 st. Lock Moer M8</b>	<b>4 st. Lock Moer M6</b>
		

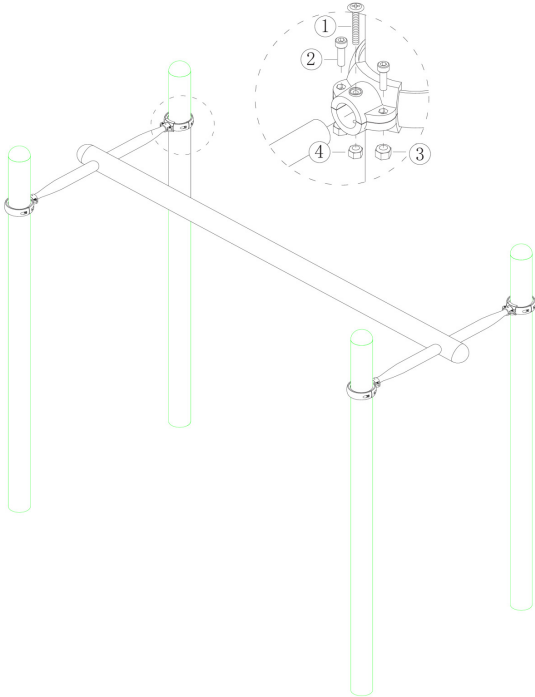

Bevestigings materiaal is per zakje verpakt en bovenstaande afbeelding zit in het zakje

## Lock Moer M6

STAP 4 van 4

**Omschrijving:** Bevestiging tussen de steps en het rek

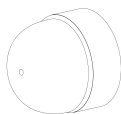
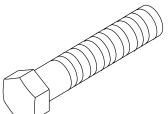
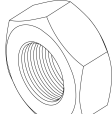
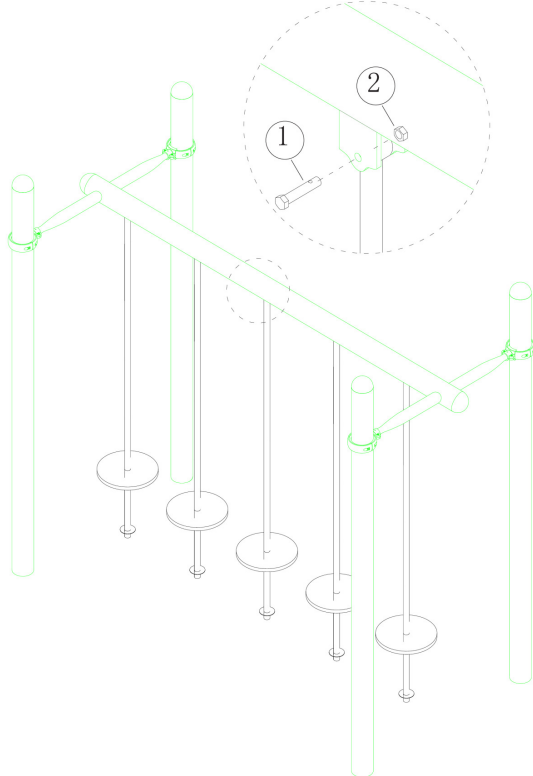
5 st. Losse step (steppenbrug)		
	5 st. M12x70	5 st. Lock Moer M12
	① 	② 
		
Bevestigings materiaal is per zakje verpakt en bovenstaande afbeelding zit in het zakje		



# Brug voor B-098

1 STUK

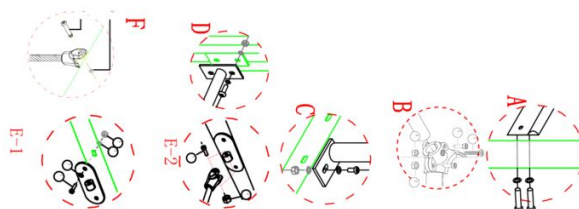
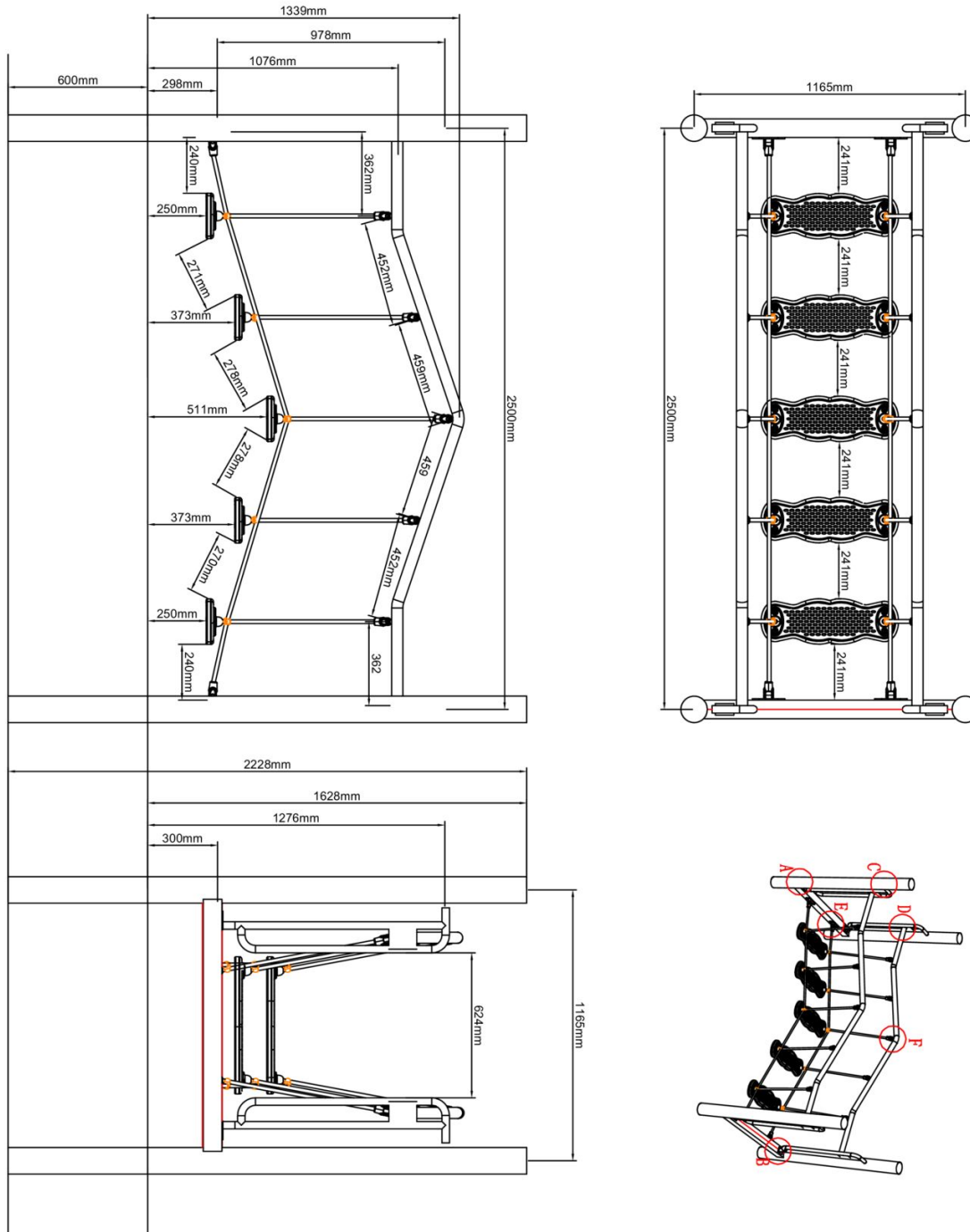

Hoofdafmetingen: 261x128x168cm



## Brug voor B-098

STAP 1 van 6

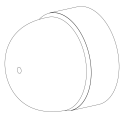

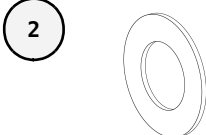
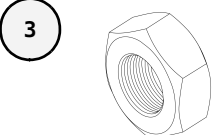
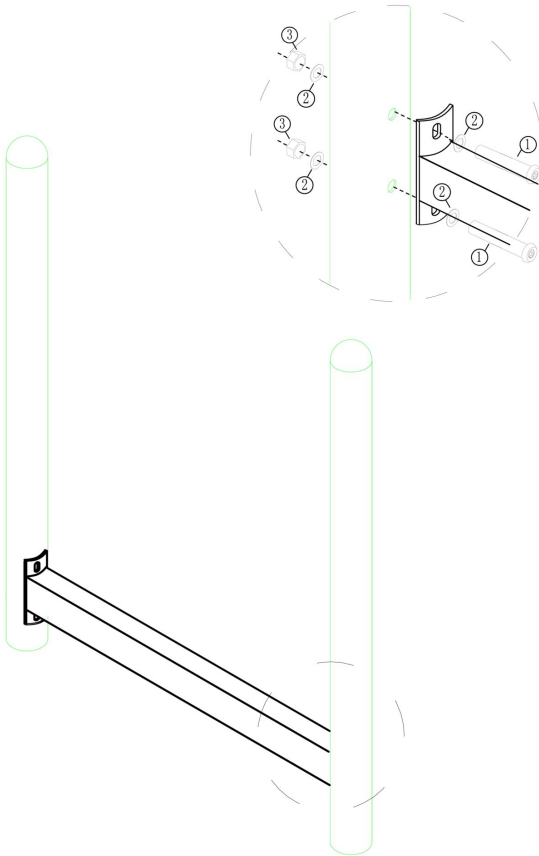



**Omschrijving:** Bevestiging tussen balk en de staanders

8 st. Afdekdop M10	8 st. Bout M10X120	16 st. Ring M10 (middel)	8 st. Lock Moer M10
			
			
Bevestigings materiaal is per zakje verpakt en bovenstaande afbeelding zit in het zakje			

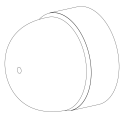
## Lock Moer M10

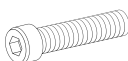
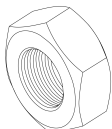
STAP 2 van 6

**Omschrijving:** Bevestiging tussen de handgrepen de staanders en de balk

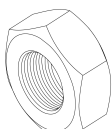
4 st. Afdekdop M10	4 st. Kruiskop M6X65	8 st. Bout M8X20	8 st. Lock Moer M8
	① 	② 	③ 
4 st. Lock Moer M6	4 st. Bout M10X80	8 st. Ring M10 (middel)	4 st. Lock Moer M10
④ 	⑤ 	⑥ 	⑦ 

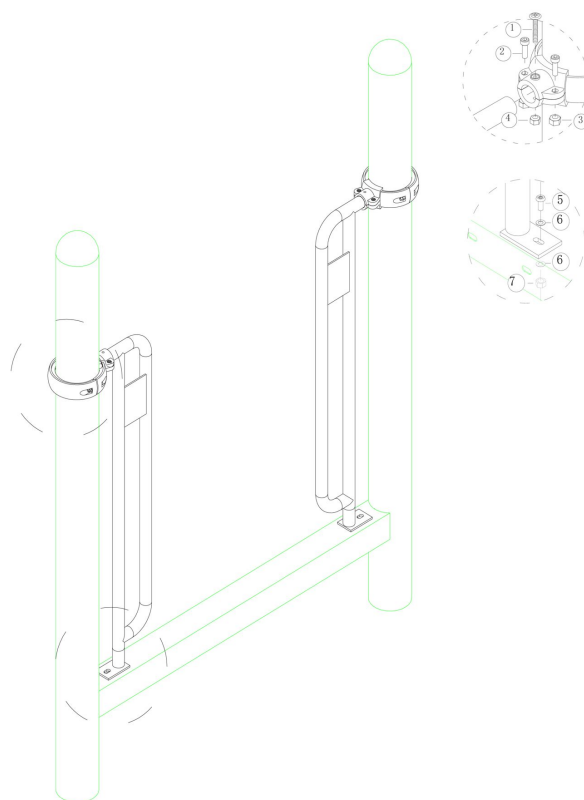

Bevestigings materiaal is per zakje verpakt en bovenstaande afbeelding zit in het zakje

## Lock Moer M10

STAP 3 van 6



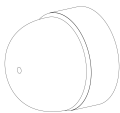
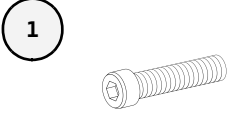
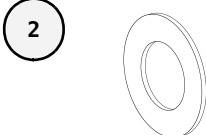
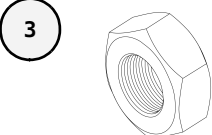
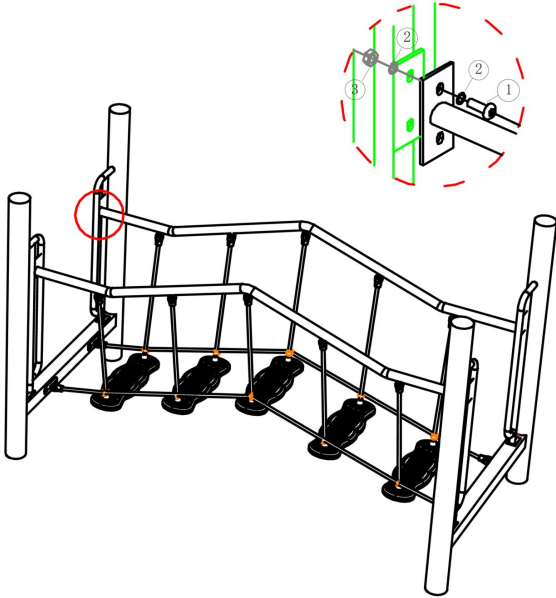

**Omschrijving:** Bevestiging tussen de brugleuningen en de handgrepen

8 st. Afdekdop M10	8 st. Bout M10X20	16 st. Ring M10 (middel)	8 st. Lock Moer M10
			
			
Bevestigings materiaal is per zakje verpakt en bovenstaande afbeelding zit in het zakje			

## Lock Moer M10

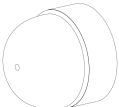
STAP 4 van 6

**Omschrijving:** Bevestiging tussen de touwen en de balk

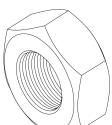
4 st. Connector stappenbrug vloer	12 st. Afdekdop M8	8 st. Bout M10X80	16 st. Ring M10 (middel)
		① 	② 
8 st. Lock Moer M10	4 st. Torx M10X55	4 st. Lock Moer M10	
③ 	④ 	⑤ 	

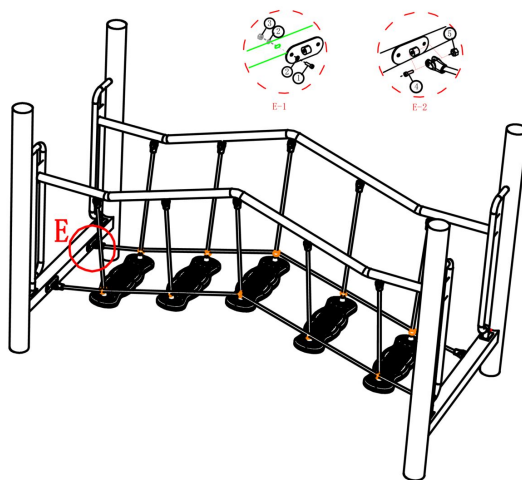



Bevestigings materiaal is per zakje verpakt en bovenstaande afbeelding zit in het zakje

## Lock Moer M10

STAP 5 van 6

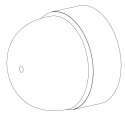
Omschrijving: Bevestiging tussen de touwen en de leuningen

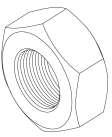
<b>10 st. Afdekdop M8</b>	
	
<b>10 st. Torx M10X55</b>	<b>10 st. Lock Moer M10</b>
<b>1</b> 	<b>2</b> 

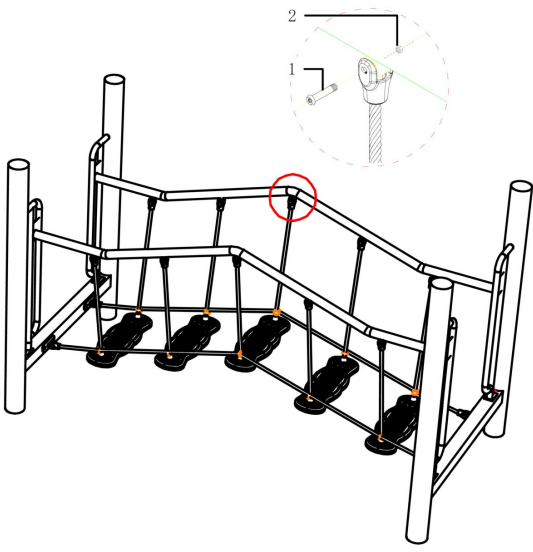
Bevestigings materiaal is per zakje verpakt en bovenstaande afbeelding zit in het zakje

## Lock Moer M10

STAP 6 van 6

**Omschrijving:** Paalkap losdraaien en opnieuw bevestigen met loctite op het draadeind

1 st. Loctite

1 

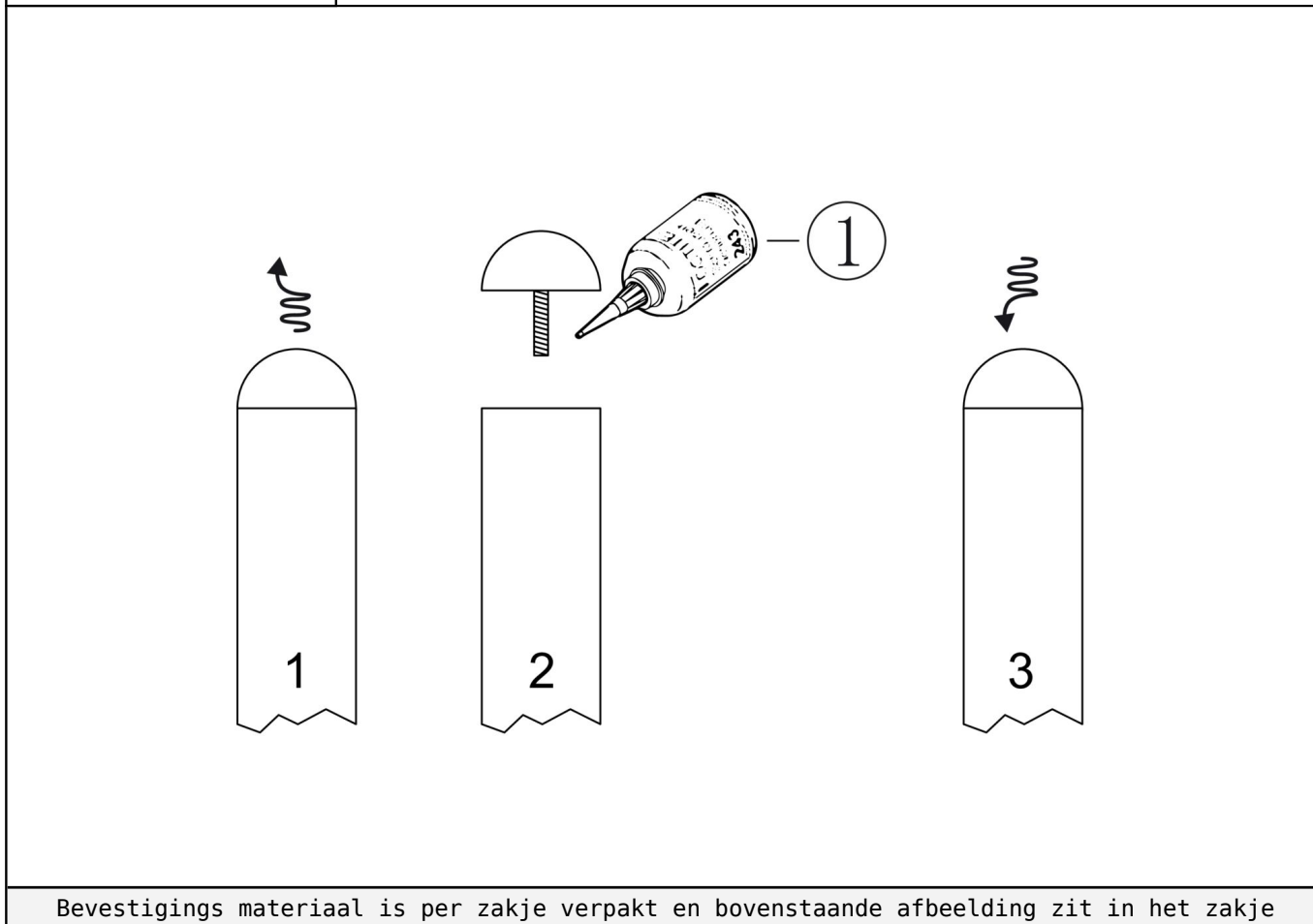

Bevestigings materiaal is per zakje verpakt en bovenstaande afbeelding zit in het zakje



B-065

1 STUK

Hoofdafmetingen: 272x934x989cm

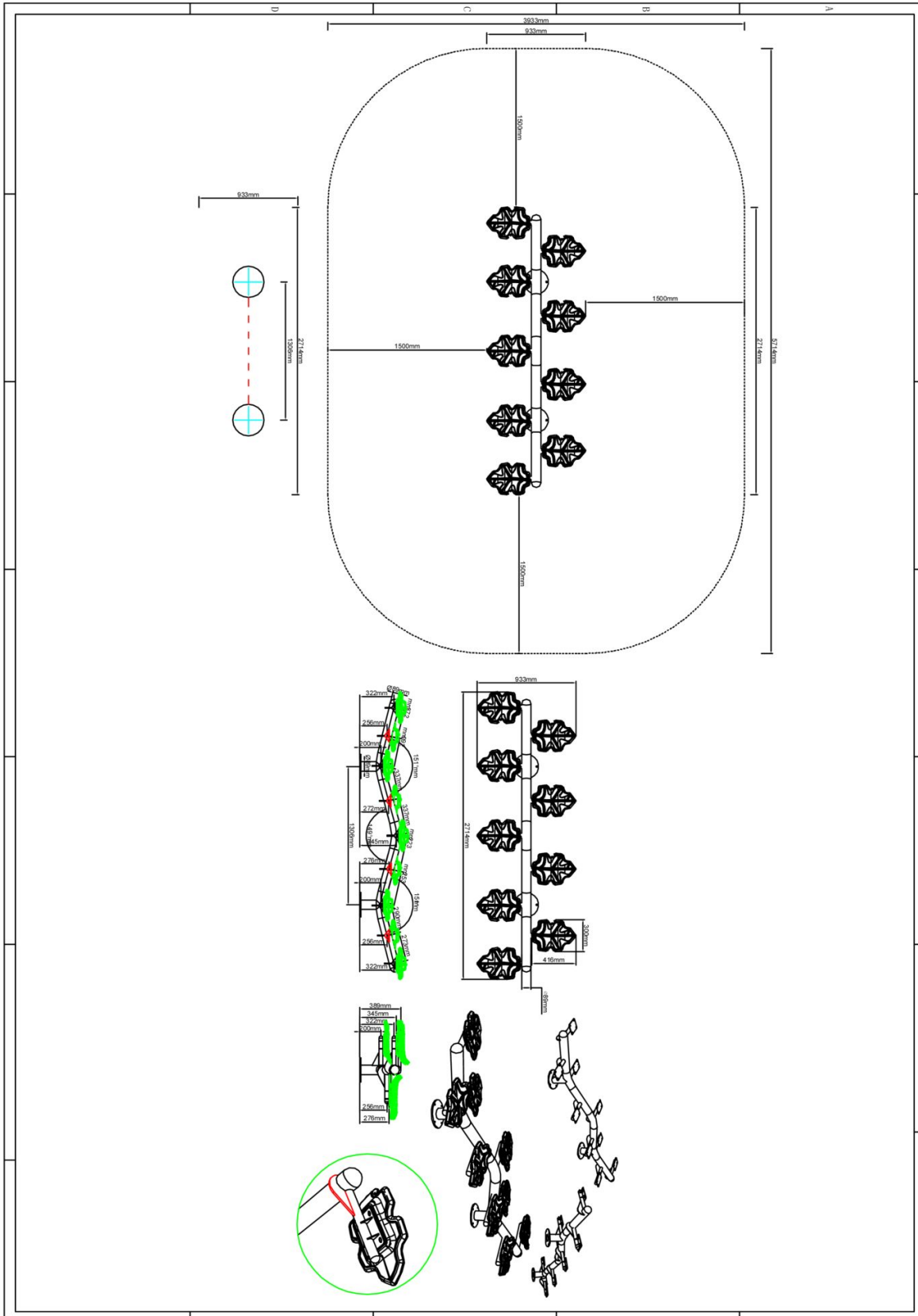



# Evenwichtsbalk

3 STUKS

Hoofdafmetingen: 131x12x100

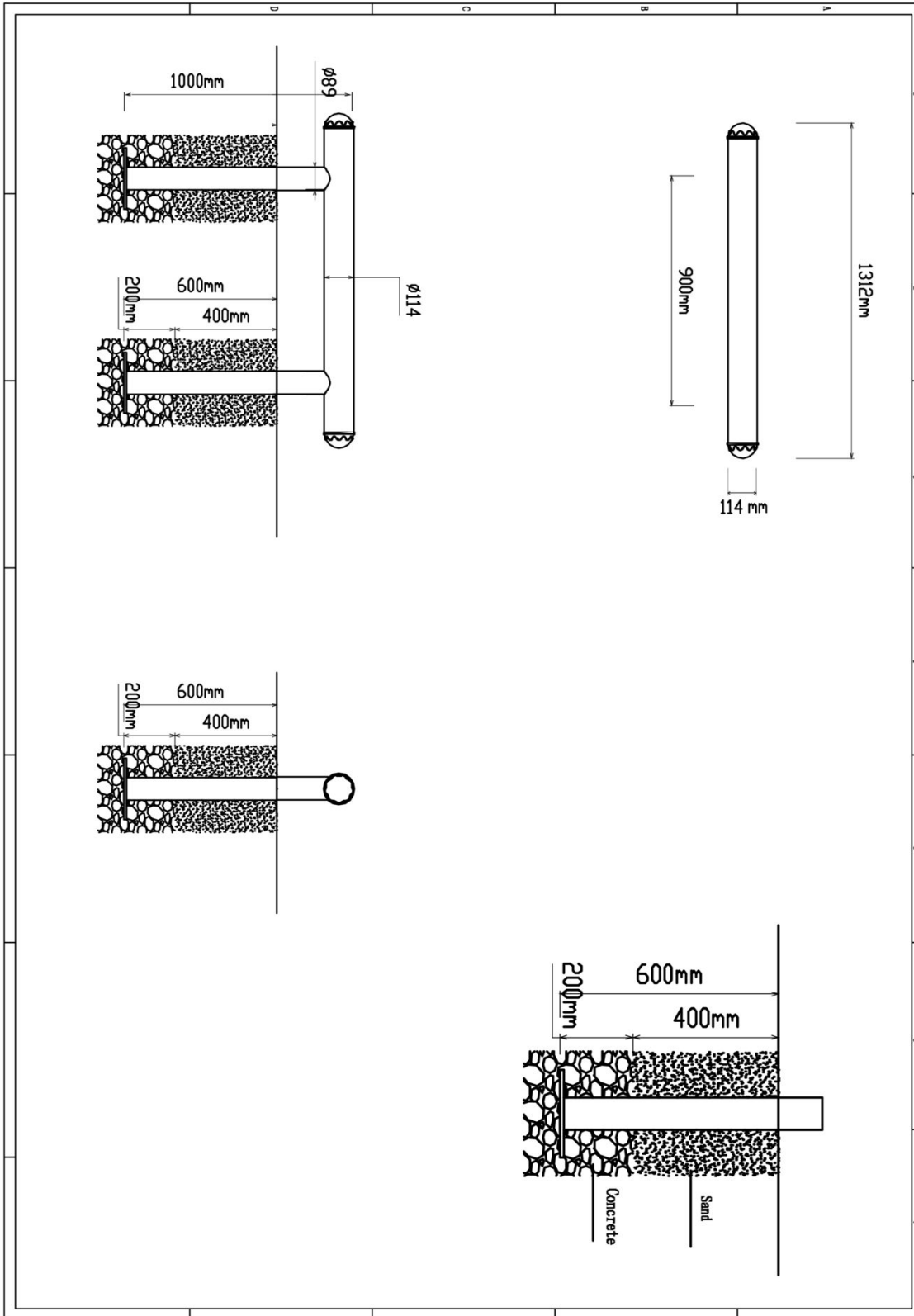



Pe Step B-098

4 STUKS

Hoofdafmetingen:  $\varnothing 45 \times 102$

