

TnT speeltoestellen

Montagehandleiding B-098

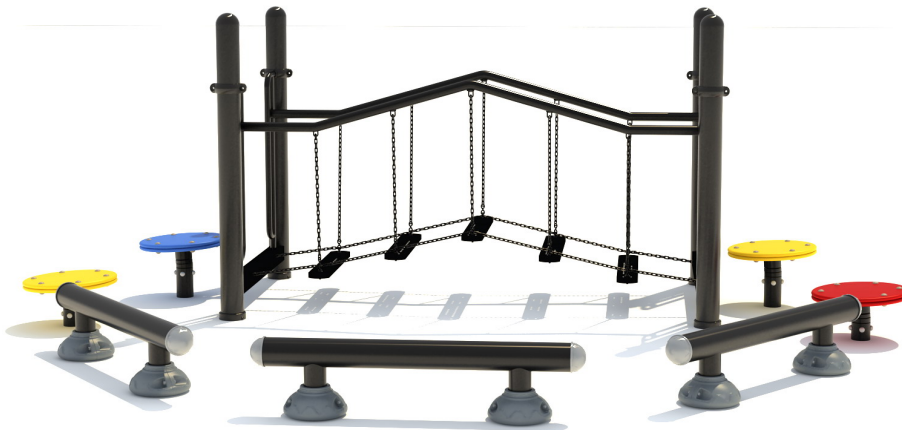

Toestel typenummer	B-098
Datum montagehandleiding	14/09/2020
Versienummer montagehandleiding	2.2

Beste klant van TnT Speeltoestellen,

Wij danken u voor het aanschaffen en installeren van een speeltoestel van TnT Speeltoestellen. Wij waarderen het vertrouwen dat u in ons bedrijf heeft geplaatst en streven ernaar om uw vertrouwen meer dan waar te maken!

Dit is uw TnT speeltoestellen montagehandleiding.

Wij hebben deze handleiding specifiek voor het product ontworpen, waarop eveneens de toe te passen onderdelen zijn genoemd.

Ook vindt u het grondplan met de benodigde valruimte volgens norm NEN-EN1176-1 : 2017.

Bewaart u dit document bij uw logboek. Nogmaals willen wij u bedanken voor de aankoop van dit speeltoestel. Wij zien uit naar uw volgende speelproject.

Met vriendelijke groet, TnT Speeltoestellen



Inhoudsopgave

Aanzichten 3D	3
Onderdelenlijst	4
Veiligheidsruimtes	5
Aanzichten 2D	6
Plattegrond palenplan	7
Onderdeel handleidingen	8
<i>Brug voor B-098</i>	9
<i>Evenwichtsbalk</i>	16
<i>Pe Step B-098</i>	17

Aanzichten 3D



Aanzicht 1



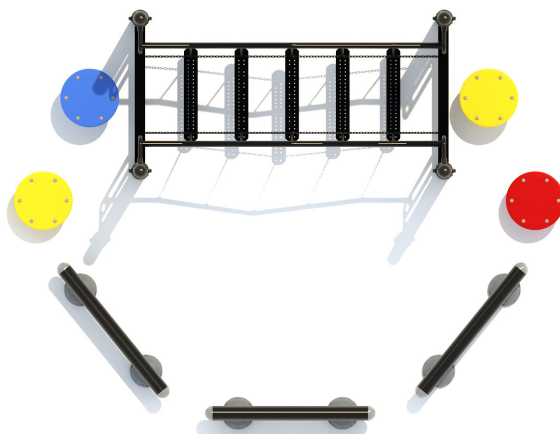

Aanzicht 2

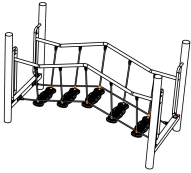

Aanzicht 3

Onderdelenlijst

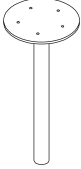
1 st. Brug voor B-098	3 st. Evenwichtsbalk	4 st. Pe Step B-098
261x128x168cm	131x12x100	Ø45x102
		

Veiligheidsruimtes

Geachte klant,

Zorg er altijd voor dat alle veiligheids ruimtes zoals aangegeven in ieder geval gehaald worden, dit zijn de minimale vereiste ruimtes voor een veilig gebruik van het speeltoestel.

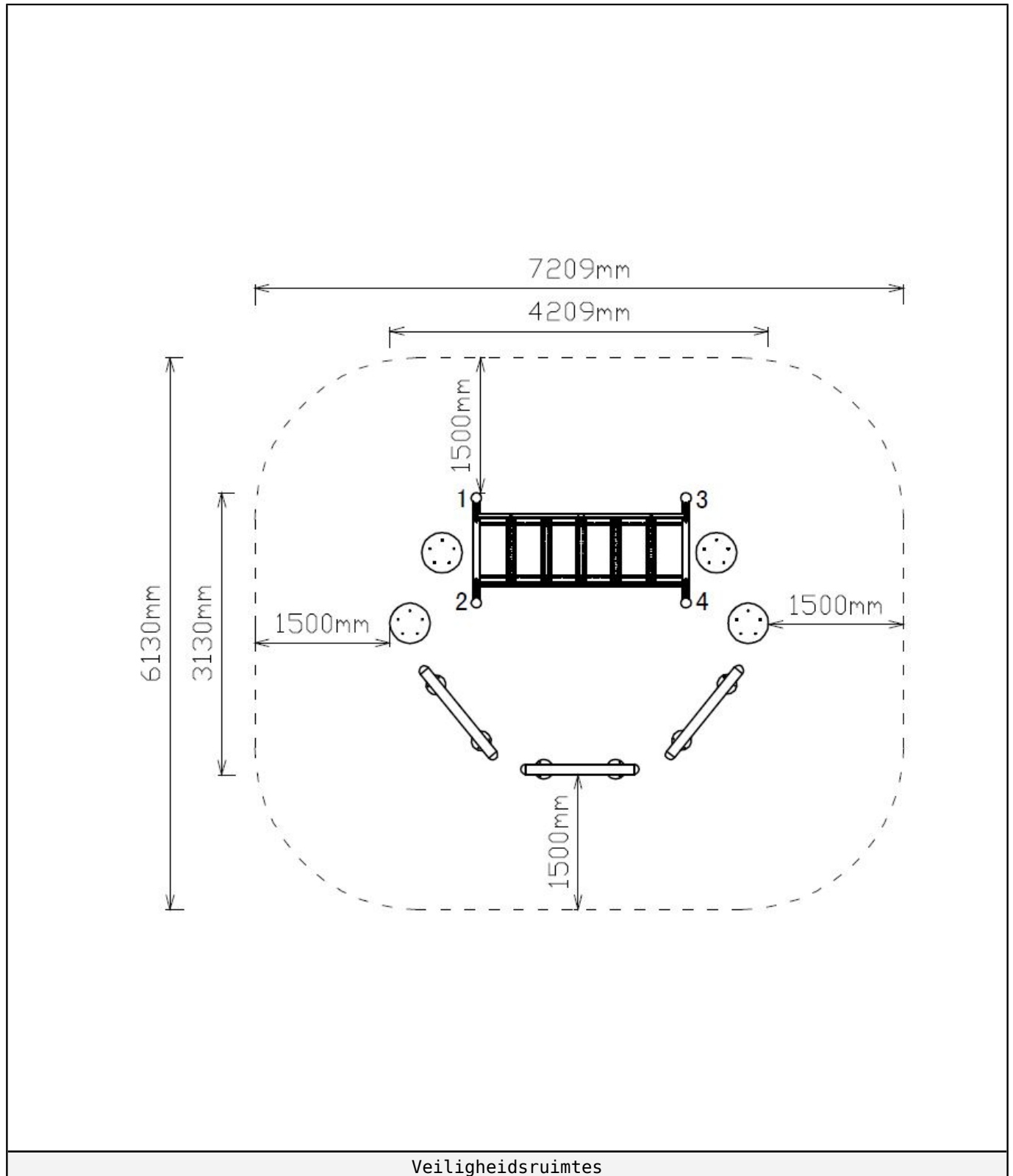

Veiligheidsruimtes

Aanzichten 2D

Hier vindt u de beschikbare aanzichtstekeningen.

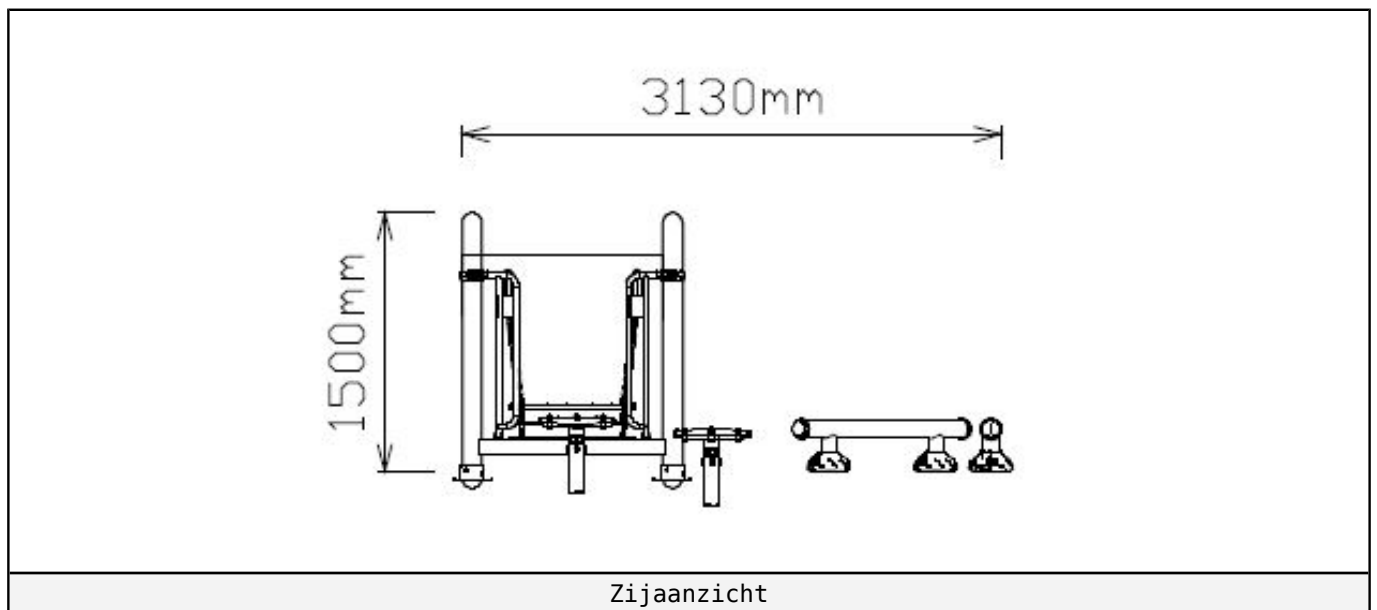
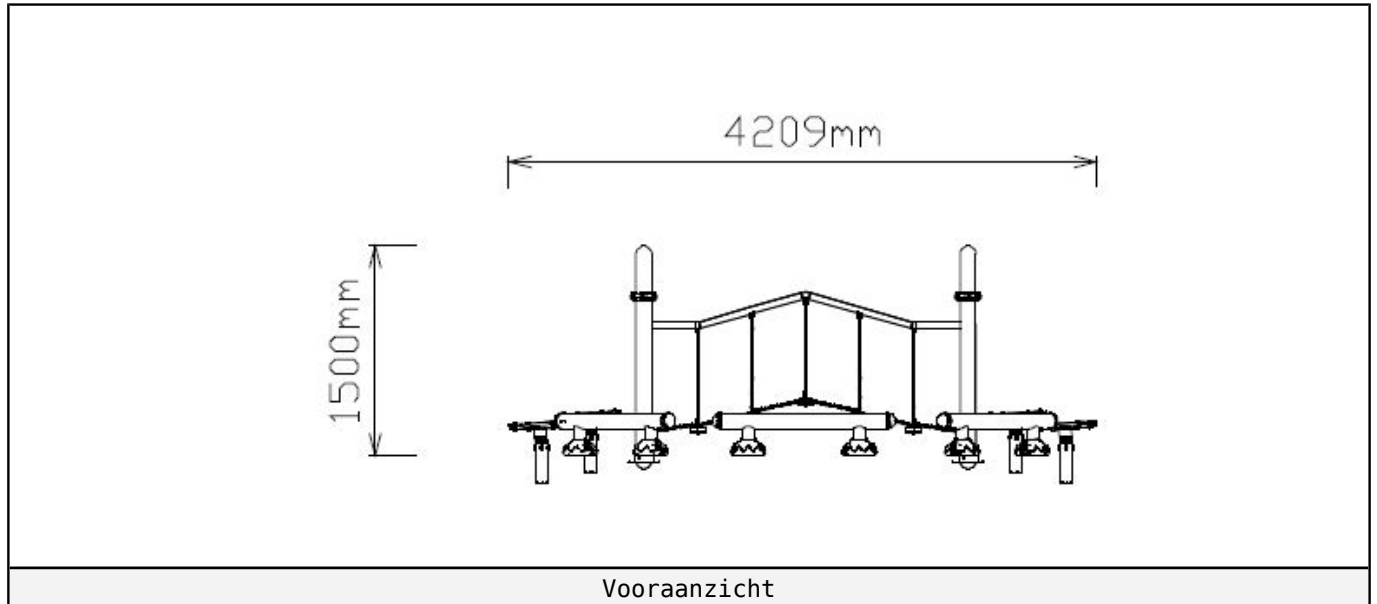

Plattegrond palenplan

U kunt van deze tekening niet afmeten!

Voor de betonfundatie heeft u 37.5 kg snelbeton per staander nodig.

Houdt u er rekening mee dat de betonfundatie minimaal 400mm onder het maaiveld blijft, zoals op de tekening afgebeeld.

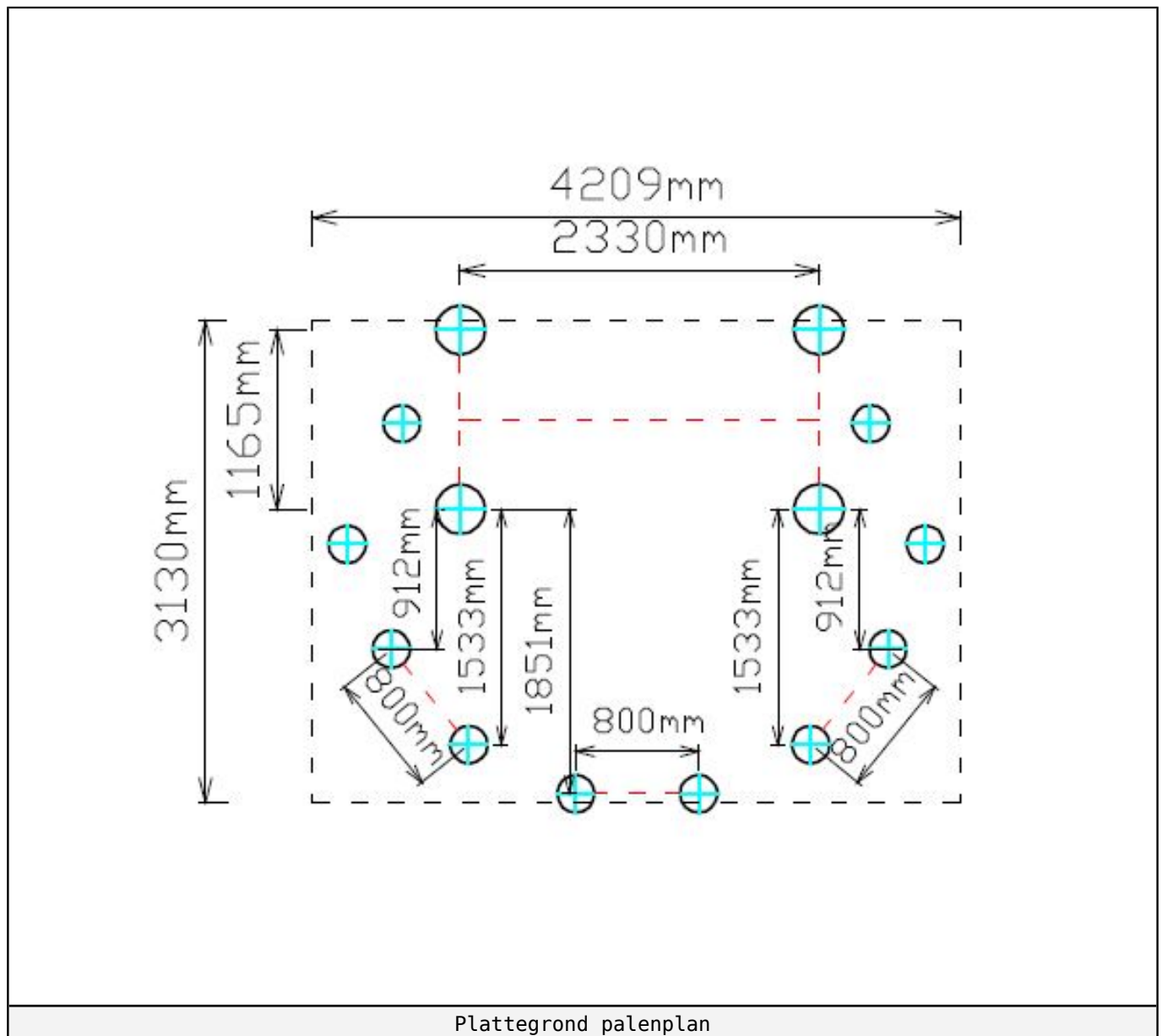

Plattegrond palenplan

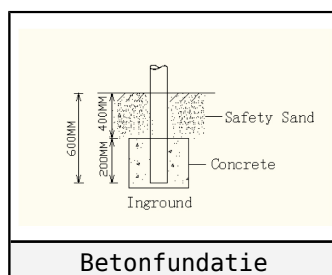

Onderdeel handleidingen

Op de volgende pagina's van dit document vindt u alle individuele onderdelen met bijhorende technische tekeningen en eventuele montage instructies.



Brug voor B-098

1 STUK

Hoofdafmetingen: 261x128x168cm

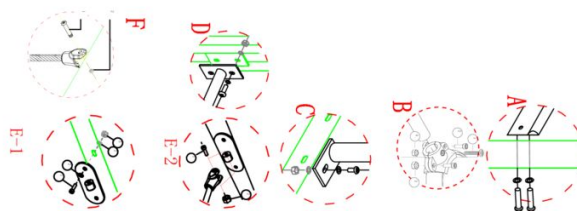
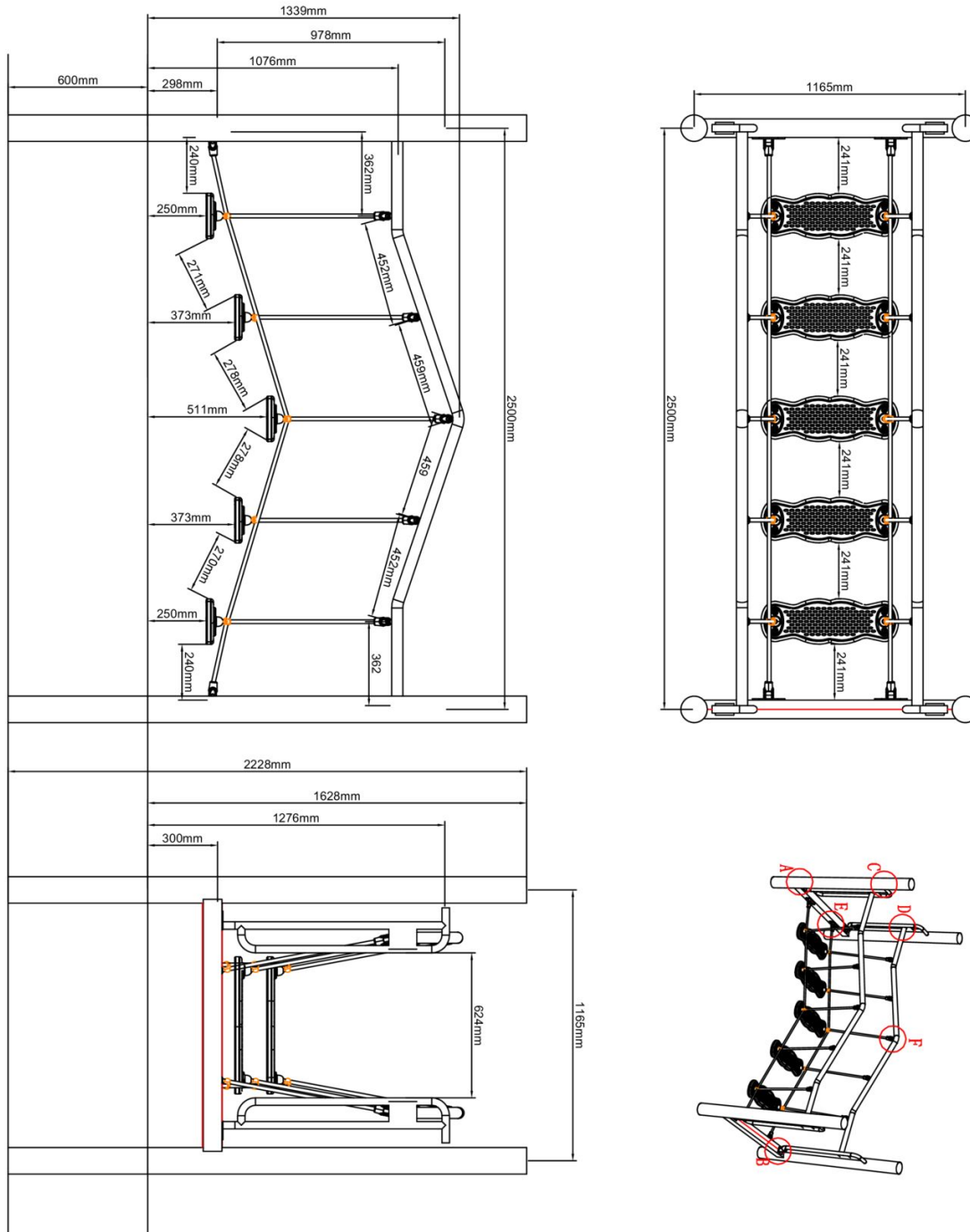





Brug voor B-098

STAP 1 van 6

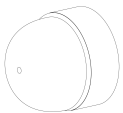

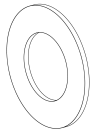
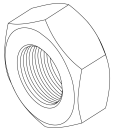
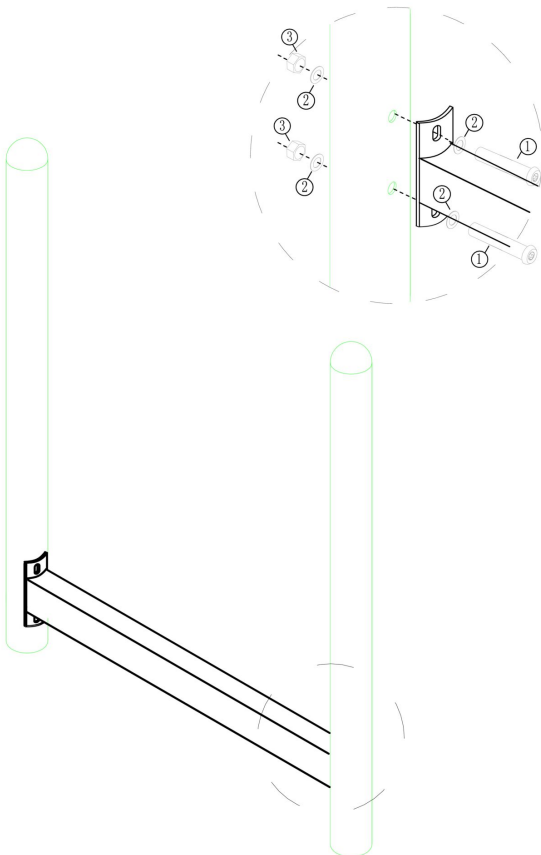



Omschrijving: Bevestiging tussen balk en de staanders

8 st. Afdekdop M10	8 st. Bout M10X120	16 st. Ring M10 (middel)	8 st. Lock Moer M10
	<p>1</p> 	<p>2</p> 	<p>3</p> 
			
Bevestigings materiaal is per zakje verpakt en bovenstaande afbeelding zit in het zakje			

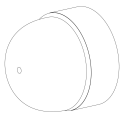
Lock Moer M10

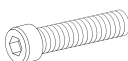
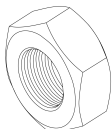
STAP 2 van 6

Omschrijving: Bevestiging tussen de handgrepen de staanders en de balk

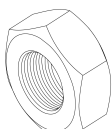
4 st. Afdekdop M10	4 st. Kruiskop M6X65	8 st. Bout M8X20	8 st. Lock Moer M8
	① 	② 	③ 
4 st. Lock Moer M6	4 st. Bout M10X80	8 st. Ring M10 (middel)	4 st. Lock Moer M10
④ 	⑤ 	⑥ 	⑦ 

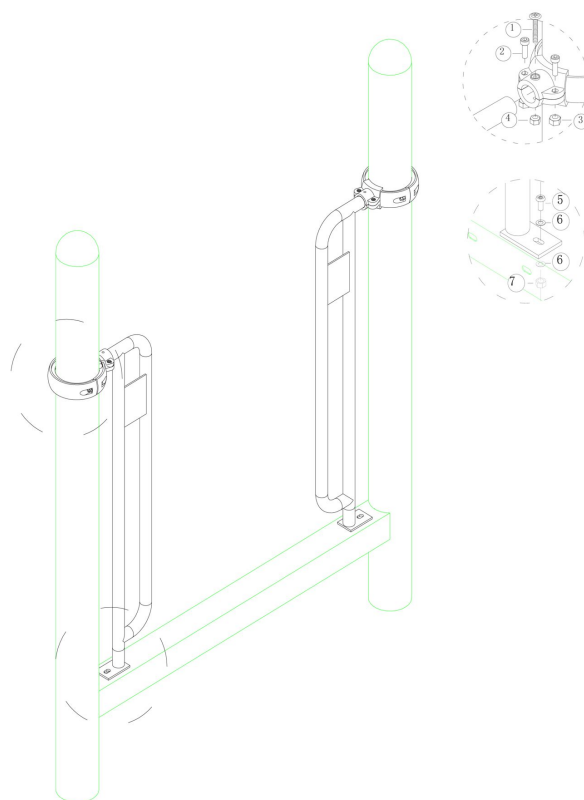

Bevestigings materiaal is per zakje verpakt en bovenstaande afbeelding zit in het zakje

Lock Moer M10

STAP 3 van 6



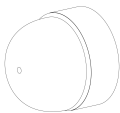
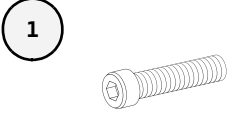
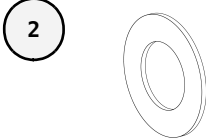
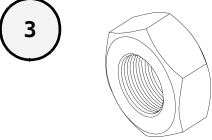
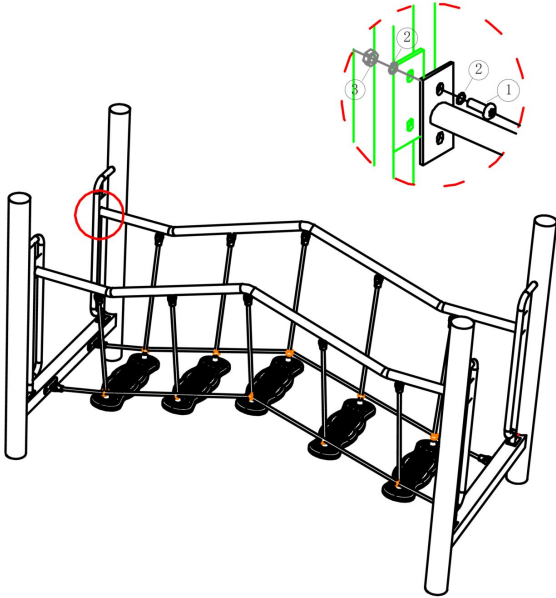

Omschrijving: Bevestiging tussen de brugleuningen en de handgrepen

8 st. Afdekdop M10	8 st. Bout M10X20	16 st. Ring M10 (middel)	8 st. Lock Moer M10
			
			
Bevestigings materiaal is per zakje verpakt en bovenstaande afbeelding zit in het zakje			

Lock Moer M10

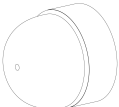
STAP 4 van 6

Omschrijving: Bevestiging tussen de touwen en de balk

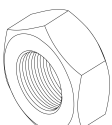
4 st. Connector stappenbrug vloer	12 st. Afdekdop M8	8 st. Bout M10X80	16 st. Ring M10 (middel)
		① 	② 
8 st. Lock Moer M10	4 st. Torx M10X55	4 st. Lock Moer M10	
③ 	④ 	⑤ 	

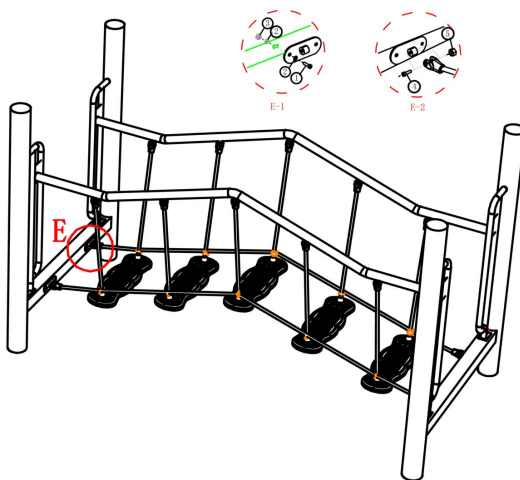

Bevestigings materiaal is per zakje verpakt en bovenstaande afbeelding zit in het zakje

Lock Moer M10

STAP 5 van 6

Omschrijving: Bevestiging tussen de touwen en de leuningen

10 st. Afdekdop M8

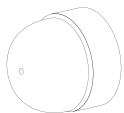

10 st. Torx M10X55

10 st. Lock Moer M10

1

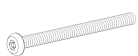

2

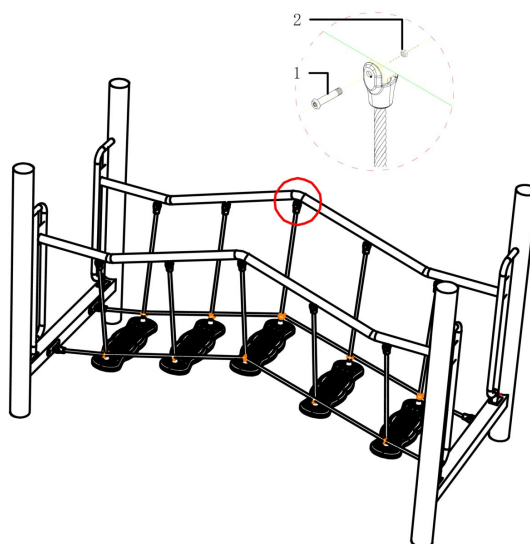

Bevestigings materiaal is per zakje verpakt en bovenstaande afbeelding zit in het zakje

Lock Moer M10

STAP 6 van 6

Omschrijving: Paalkap losdraaien en opnieuw bevestigen met loctite op het draadeind

1 st. Loctite

1 

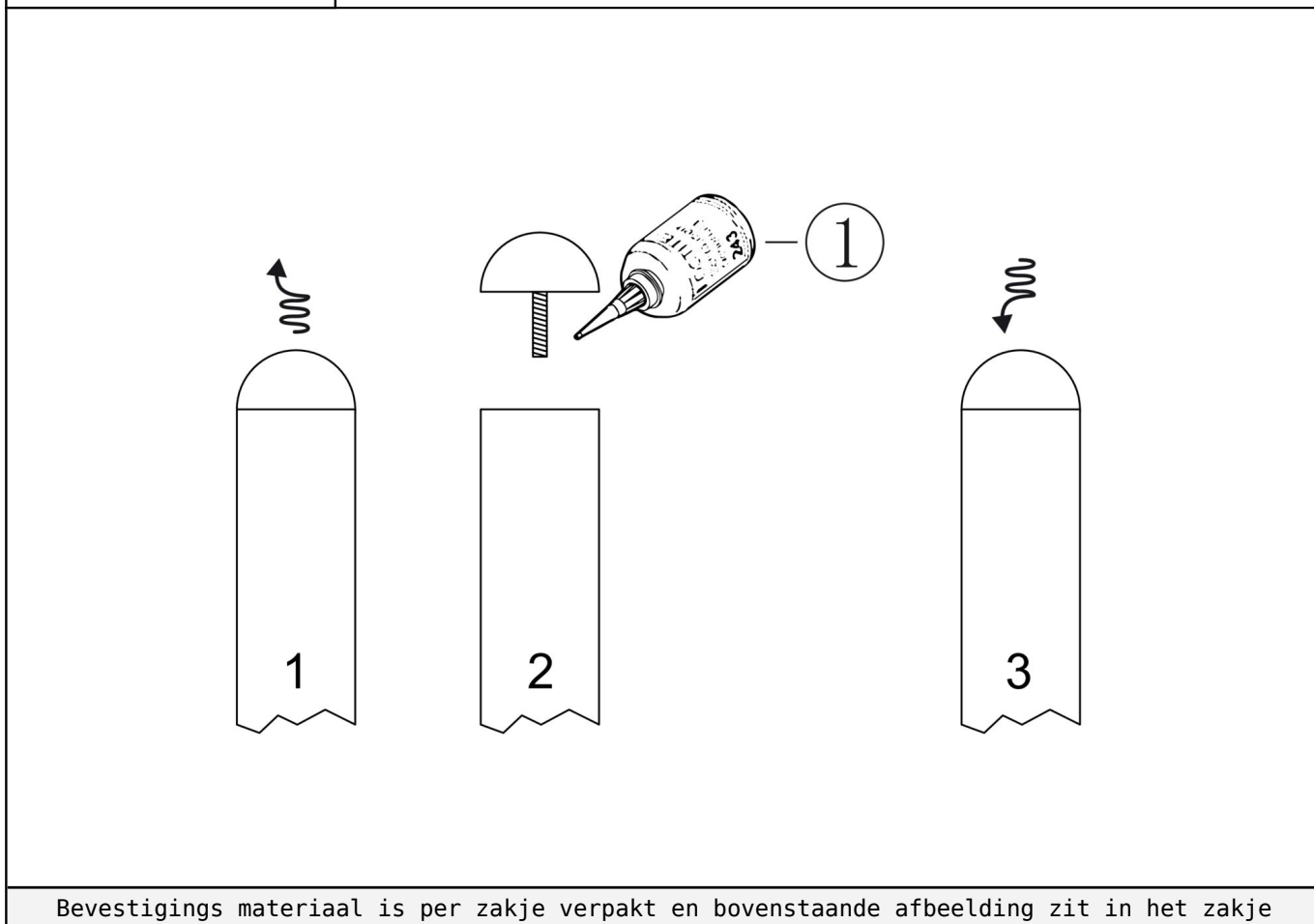

Bevestigings materiaal is per zakje verpakt en bovenstaande afbeelding zit in het zakje



Evenwichtsbalk

3 STUKS

Hoofdafmetingen: 131x12x100

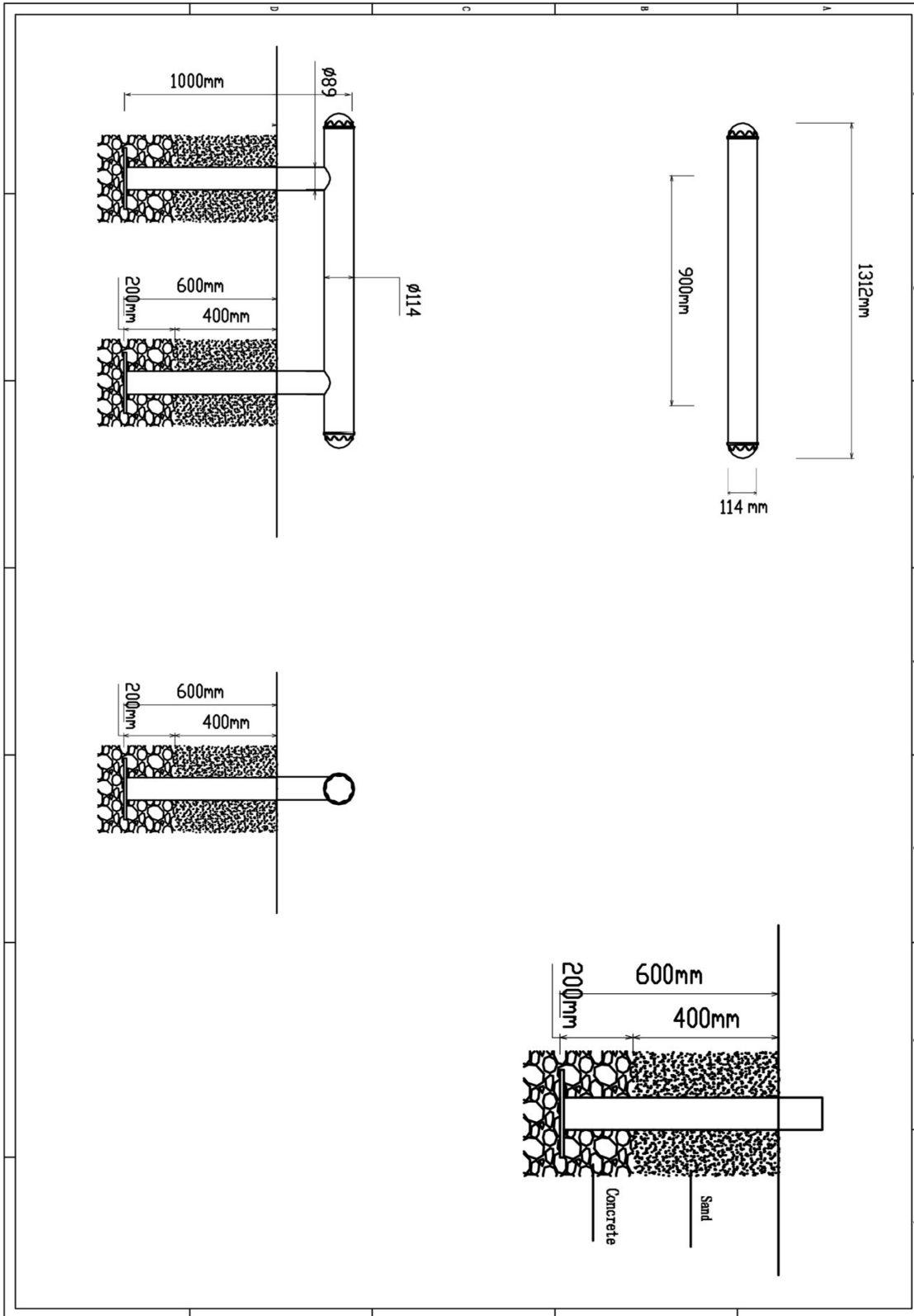



Pe Step B-098

4 STUKS

Hoofdafmetingen: $\varnothing 45 \times 102$

